

# RADOX

RADIATORS





RADOX

**30**  
RADOX  
YEARS

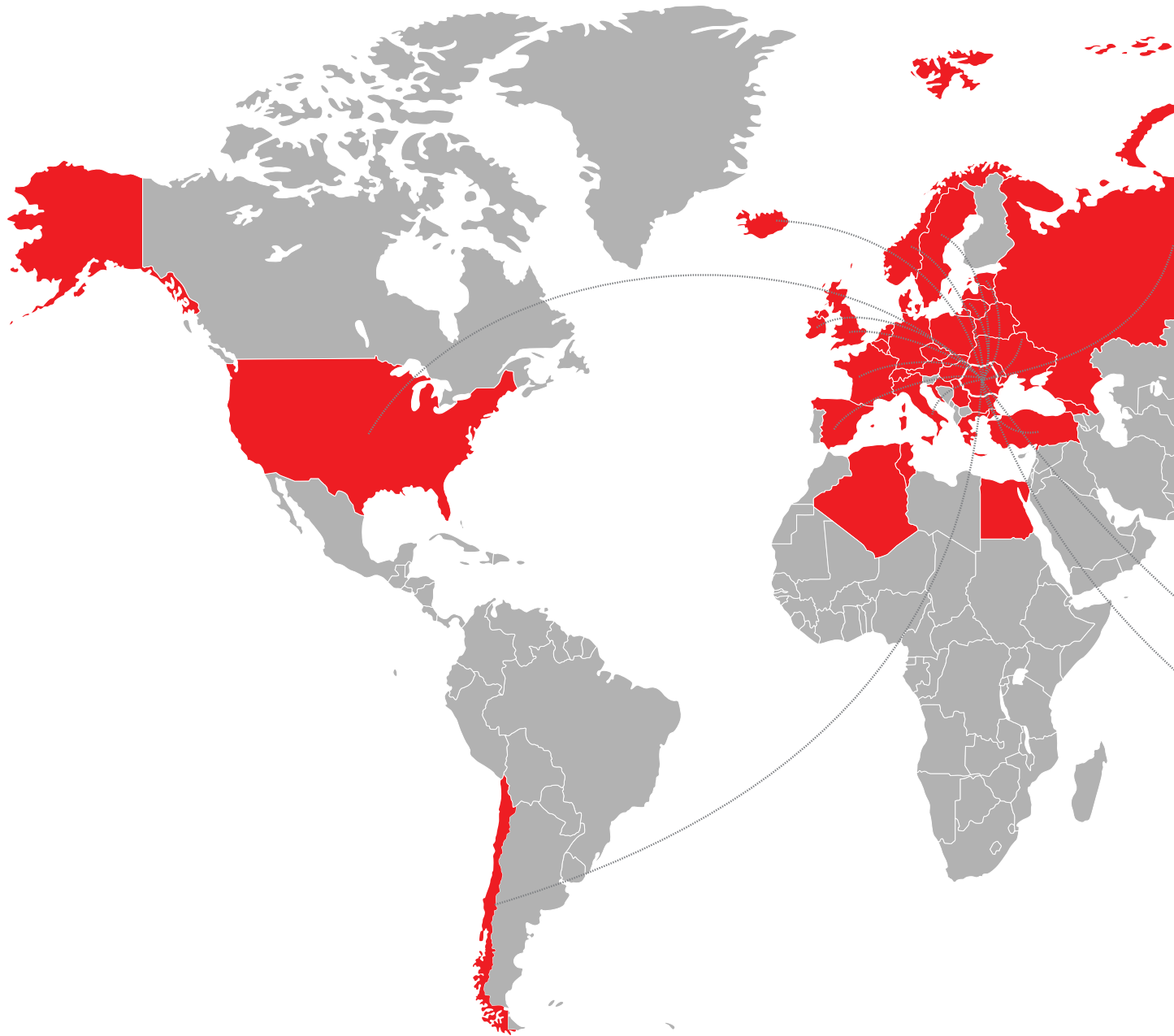

# RADOX

SINCE 1993 | DIN 1993

RADOX is a well known brand in the field of home heating comfort, synonymous with passion, design, quality and consistency. We have more than 30 years of experience within this industry, not only in Romania, but also in more than 45 countries on 5 continents. We are a proud European manufacturer. Our 2 factories are our „heart”. We earn customer loyalty through excellence in quality, reliability and innovation. The catalogue that we provide is the result of the work of more than 200 people. It is our knowledge, passion and experience, always in the pursuit of excellence and constant attention to the supplied product and service. Each year we sell tens of thousands of radiators and convectors worldwide. This catalogue presents a selection of our products and we are always open for custom products and OEM projects.

*RADOX este o marcă recunoscută pe plan național și internațional în domeniul încălzirii și climatizării, sinonimă cu pasiunea, designul, calitatea și consecvența. Avem peste 30 de ani de experiență în acest domeniu, nu numai în România, dar și în peste 45 de țări pe 5 continente. Ne mândrim cu faptul că suntem producător european. Cele două fabrici reprezintă „inima” activității noastre. Acest catalog este rezultatul muncii a mai mult de 200 de oameni. Regăsiți aici cunoștințele, pasiunea și experiența noastră, mereu aspirând spre excelență și acordând atenție permanentă tuturor produselor și serviciilor furnizate. În fiecare an, vindem zeci de mii de radiatoare și convectori pe tot mapamondul. Acest catalog prezintă o selecție a produselor noastre, însă suntem mereu deschiși discuțiilor despre produse la comandă și proiecte OEM.*



# From concept to production

## De la concept la producție

RADOX headquarters in Bucharest / Sediul RADOX din Bucuresti



<b>1993</b> Beginning of the HVAC activity Începutul activității HVAC	Turnover of about € Cifra de afaceri de aprox. <b>18 millions</b> milioane	<b>200 +</b> employees angajați	<b>47.000 mp</b> sqm HQ & production sites sediul și fabricile	No outsourcing Fără servicii externalizate	<b>45</b> export countries țări unde exportăm	<b>10 years</b> ani guarantee garanție	<b>86 %</b> export of design radiators export al radiatoarelor de design	<b>8 tons</b> steel tubes processed per day țevi de oțel prelucrate zilnic
---	---	---------------------------------------	--	---	---	---	--	--

The RADOX story started in 1993 as a family business, but it has evolved sustainably into a business with over 200 employees, a network of respected collaborators worldwide and two factories in Romania - in Bucharest and Câmpulung Muscel - 47.000 sqm.

*Povestea RADOX a început în 1993 ca o afacere de familie, însă a evoluat sustenabil într-un business cu peste 200 de angajați, cu o rețea de colaboratori respectați la nivel internațional și cu două fabrici în România - în București și Câmpulung Muscel - 47.000 mp.*

We use the best chrome plating station in Central and Eastern Europe (Ni-Ni-Cr), fully automated and environmentally friendly. Together with our epoxy painting installation, we can guarantee the product quality through the entire manufacturing process.

*Folosim cea mai performantă instalație de cromare din Europa Centrală și de Est (Ni-Ni-Cr), complet automatizată și ecologică. Alături de instalația noastră de vopsire în câmp electrostatic, putem garanta controlul asupra calității produsului pe tot parcursul procesului de fabricație.*

# RADOX

NOVA Horizontal design radiator



SERPENTINE design towel radiator



## The RADOX commitment

The high quality of RADOX products is our promise to local and international customers - and we keep it every time.

- Each radiator produced by us goes through 9 control points, thus ensuring the superior quality of the products.
- Our brazing process ensures optimum durability and corrosion resistance, which significantly increases the life of the radiator.
- ALL our radiator caps are welded by the "TIG" process, creating a perfect seal to prevent water leaks.
- We have NOT used and will NEVER use in our production process substances with devastating effects on the environment.

## Promisiunea RADOX

*Calitatea înaltă a produselor RADOX este promisiunea noastră către clienții locali și internaționali - și o respectăm de fiecare dată.*

- *Fiecare radiator produs de noi trece prin 9 puncte de control, astfel asigurând calitatea superioară a produselor.*
- *Procesul nostru de sudare prin brazare asigură o optimă durabilitate și rezistență la coroziune, ceea ce crește în mod semnificativ durata de viață a radiatorului.*
- *TOATE capacele radiatoarelor noastre sunt sudate prin procedeul TIG, creând o etanșare perfectă pentru prevenirea problemelor de scurgeri de apă.*
- *Nu am utilizat și nu vom utiliza NICIODATĂ, substanțe cu efecte devastatoare asupra mediului.*

## RADOX INSPIRATIONS, ONLINE AND OFFLINE

For more information, visit our websites [www.radox.ro](http://www.radox.ro), [www.radox-radiators.com](http://www.radox-radiators.com), follow us on Instagram and Facebook, or browse and select your radiator in your preferred color finish on our design page, [design.radox.ro](http://design.radox.ro).

## INSPIRAȚII RADOX, ONLINE ȘI OFFLINE

Pentru mai multe informații, vizitați site-urile noastre [www.radox.ro](http://www.radox.ro), [www.radox-radiators.com](http://www.radox-radiators.com), urmăriți-ne pe Instagram și Facebook sau alegeți radiatorul în finisajul preferat de pe pagina noastră de design, [design.radox.ro](http://design.radox.ro).





## We offer heating solution for inspiring interiors

RADOX radiators are produced in chrome, stainless steel, standard white painted, as well as in any color chosen by the customer from our colour chart. See pag. 194 for more details.

MEGA BURLANI, Custom-made radiator



## Oferim soluții de încălzire pentru interioare pline de inspirație

Radiatoarele RADOX sunt produse în variantă cromată, inox, vopsite alb-standard, precum și în orice culoare aleasa de client din paleta RADOX de culori. La pag. 194 găsiți mai multe detalii.

FAN 8, Custom-made radiator

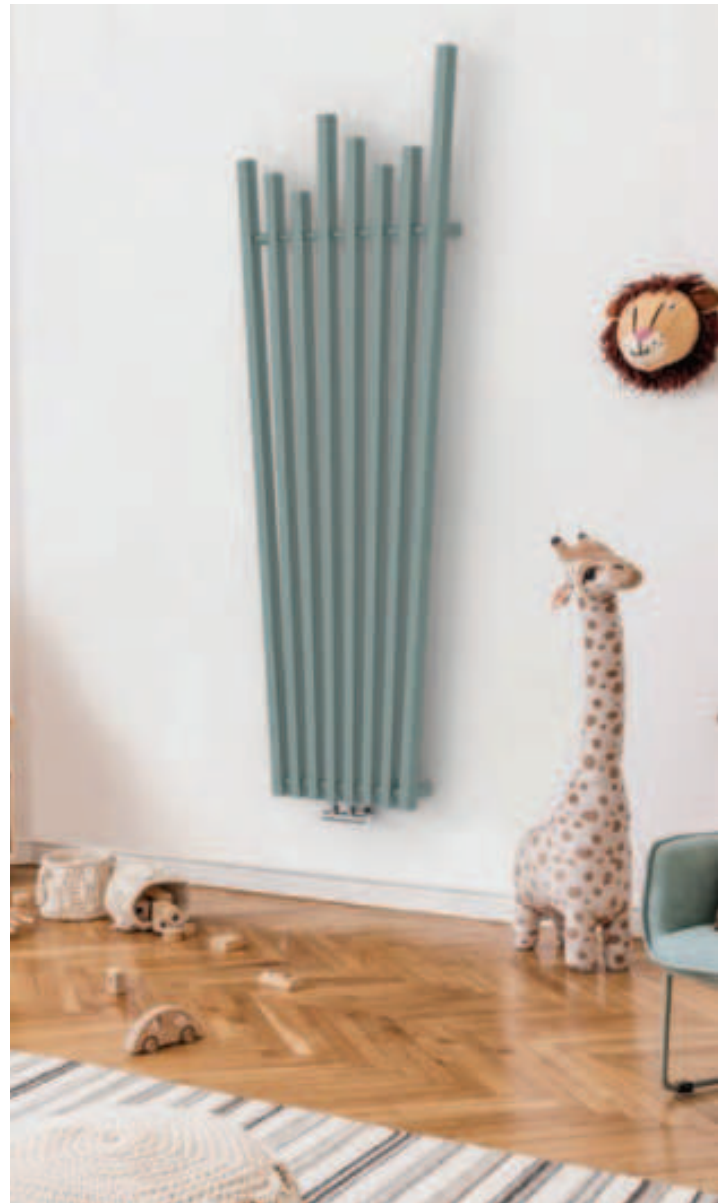

MAZE, Custom-made radiator



# INDEX

## Designer radiators | Radiatoare de design

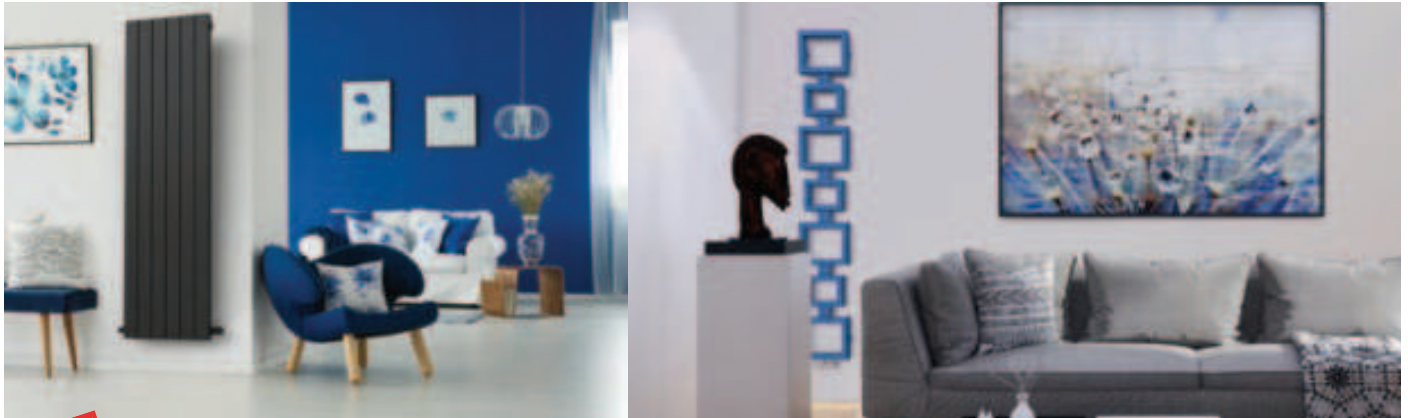

<b>NEW/NOU</b>					
BELL	pag. 12	BROC	pag. 36	MEGA BURLANI	pag. 62
BIG BELL	pag. 14	CENTO 15	pag. 38	MULTICOLONA SQUARE	pag. 64
HEATON	pag. 16	CIRCLE	pag. 40	NOVA	pag. 66
HENDRA	pag. 18	COMBI	pag. 42	NOVA GLASS/MIRROS	pag. 68
KING 20	pag. 20	COMBI GLASS	pag. 44	NOVA PP 45	pag. 73
PIGLET	pag. 22	FAN	pag. 46	RC CONVECTORS	pag. 74
ARAMIS 2	pag. 24	INVISIBLE 40	pag. 48	TOSCA 20	pag. 76
BLISS	pag. 26	INVISIBLE 40 WOOD	pag. 50	VERTICA D	pag. 78
EMPIRE TOSCA 20	pag. 28	KING	pag. 52	VERTICA D BI	pag. 80
PREMIER XL SPACE	pag. 30	KOLONA SP35	pag. 54	VERTICA D MIRROR	pag. 82
POLTER	pag. 33	LYA	pag. 56	VESTA	pag. 84
ARENA	pag. 34	MAZE	pag. 58	VESTA UNO	pag. 86
		MEGA	pag. 60	WAVE	pag. 88

## Standard towel radiators | Radiatoare standard de baie



CELSIUS	pag. 90
SCALA N	pag. 92
SUNIT P100	pag. 94

## Designer towel radiators | Radiatoare de baie

APOLLO	pag. 96	LINX	pag. 118	UPPER QUADRO	pag. 140
APOLLO FLEXI	pag. 98	PREMIER XL	pag. 120	VULCAN NV	pag. 142
ARAMIS	pag. 100	QUEBIS	pag. 122	VULCAN NV FLEXI	pag. 144
ARIAL	pag. 102	RICO	pag. 124		
AZTEC	pag. 104	RIVER	pag. 126		
BOKA	pag. 106	SERA	pag. 128		
BREAK Q	pag. 108	SERENE	pag. 130		
DORA 70	pag. 110	SERPENTINE	pag. 132		
EMPIRE	pag. 112	SMART U	pag. 134		
ESSE	pag. 114	SUNNY FLEXI	pag. 136		
KAZAR L	pag. 116	UPPER	pag. 138		

## Underfloor convectors | Convectori de pardoseală



Classic: RCF / RCN	pag. 146
Special Projects RCNa/RCNz	pag. 150
Clima: RCFr	pag. 152
Pool: RCFu	pag. 154



## Electric & mixed radiators | Radiatoare electrice și mixte

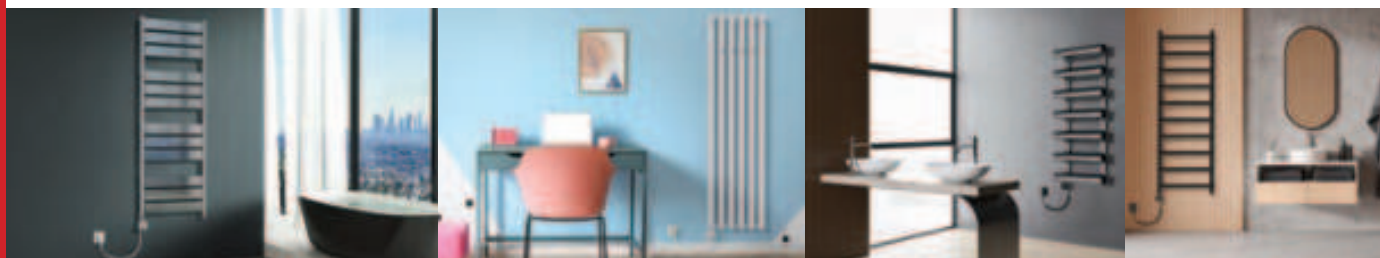

CIRCLE	pag. 156	POLTER	pag. 168	EMPIRE	pag. 180
FAN	pag. 157	SCALA N	pag. 169	LINX	pag. 181
HEATON	pag. 158	SUNIT P100	pag. 170	PREMIER XL	pag. 182
INKA	pag. 159	APOLLO	pag. 171	PREMIER XL SPACE	pag. 183
KOLONA SP35	pag. 160	ARAMIS	pag. 172	QUEBIS	pag. 184
KING	pag. 161	ARAMIS 2	pag. 173	RIVER	pag. 185
NOVA PMIX2	pag. 162	ARIAL	pag. 174	SERA	pag. 186
NOVA PMIX2 Glass	pag. 163	AZTEC	pag. 175	SERENE	pag. 187
NOVA PPMIX2	pag. 164	BLISS	pag. 176	UPPER	pag. 188
PIGLET	pag. 165	BOKA	pag. 177	UPPER QUADRO	pag. 189
RC CONVECTORS	pag. 166	BREAK Q	pag. 178	VULCAN NV	pag. 190
CELSIUS	pag. 167	DORA 70	pag. 179		

## Technical information | Informații tehnice

Premium accessories / Accesorii premium	pag. 192	Mixed radiators / Radiatoare mixte	pag. 202
Colours and finishes / Culori și finisaje	pag. 194	Mounting kits / Kit console de prindere	pag. 203
Valves / Robineți	pag. 198	Conditions & Terms /	
Electrical radiators / Radiatoare electrice	pag. 201	Condiții generale de vânzare	pag. 208



Max. working pressure/  
Presiune max. de lucru 7 bar



Max. working temperature/  
Temperatură max. de lucru 90 °C



Mounting kit included/  
Kit montaj inclus: K05



Factory pressure test/  
Presiune de probă: 10 bar



Elements & collectors/  
Elemente și colectori: Ø60x30 mm

NEW/NOU

# Bell



BELL radiators are stylish and functional heating solutions, adding a modern touch to any room, with their evenly spaced rectangles that run vertically.

Radiatoarele BELL sunt soluții de încălzire elegante și eficiente care adăuga o notă modernă oricărei încăperi, cu seria lor de dreptunghiuri uniform distanțate, care se desfășoară pe verticală.

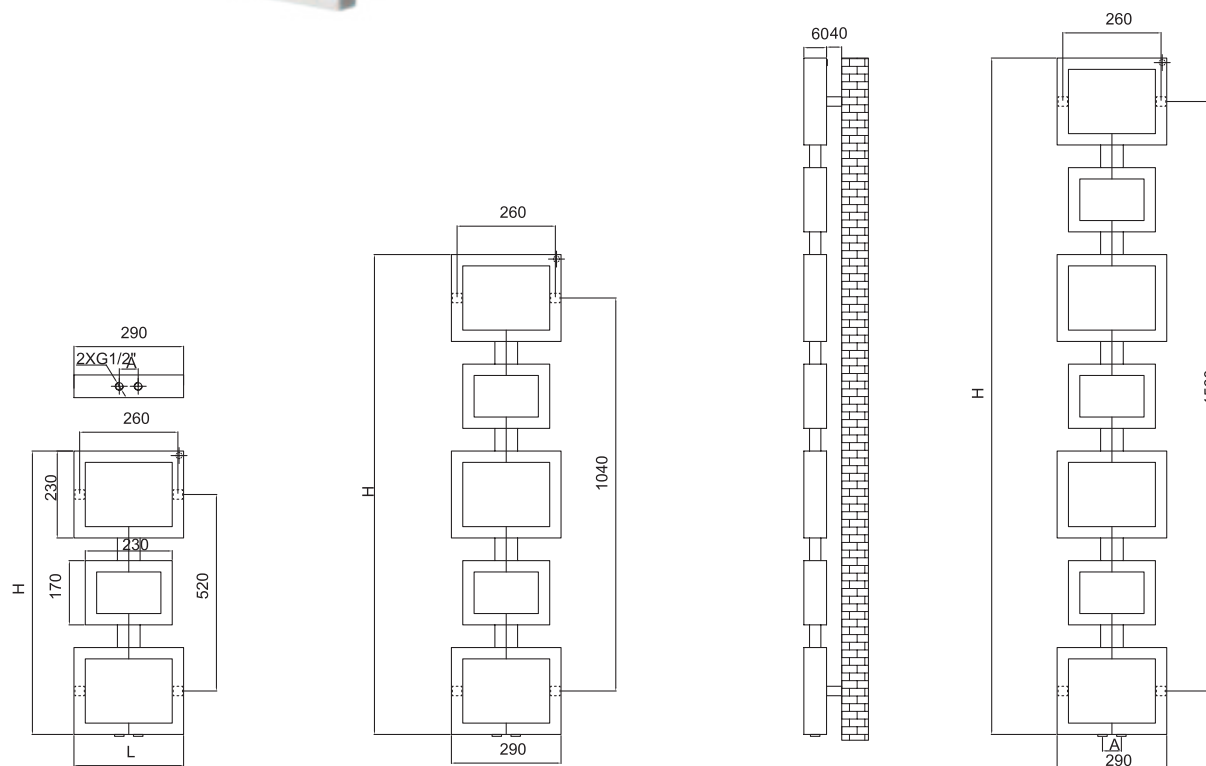



Hydraulic connections/  
Conexiuni hidraulice

Code Cod	Finish Finisaj	Height Înălțime (H)	Length Lățime (L)	Centres Interax (A)	No el Nr elemente	Weight Greutate	Volume Volum	Output / Putere termică (watt)		
								$\Delta t=30^{\circ}\text{C}$	$\Delta t=50^{\circ}\text{C}$	$\Delta t=60^{\circ}\text{C}$
		mm	mm	mm	pcs	kg	l	W	W	W
BELL750*03V9010	RAL 9010/ white/alb	750	290	50	3	6,5	3,5	112	215	269
BELL1270*05V9010		1270	290	50	5	10,8	5,8	187	360	450
BELL1790*07V9010		1790	292	50	7	15,1	8,1	260	500	625



 Max. working pressure/  
Presiune max. de lucru 7 bar

 Max. working temperature/  
Temperatură max. de lucru 90 °C

 Mounting kit included/  
Kit montaj inclus: K06

 10 bar Factory pressure test/  
Presiune de probă: 10 bar

 Elements&collectors/  
Elementi și colectori: Ø60x30 mm

NEW/NOU

# Bell Big

With a minimalist, geometrical look, BELL BIG is a decorative radiator with a perfect sense of balance, offering a great thermal output and originality in any contemporary setting.

Cu un aspect minimalist, geometric, BELL BIG este un radiator decorativ cu un simț perfect al echilibrului, oferind o putere termică ridicată și originalitate în orice stil de amenajare interioară.

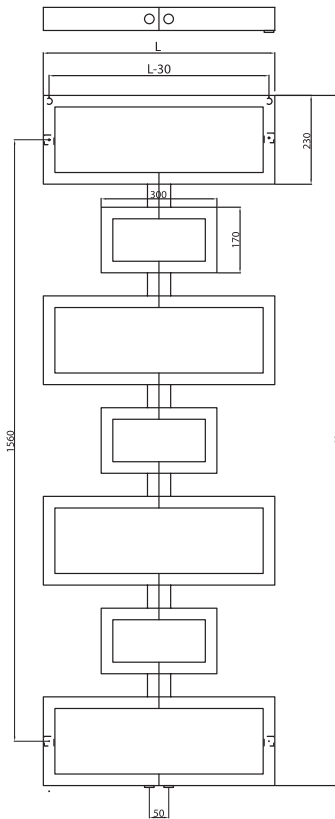
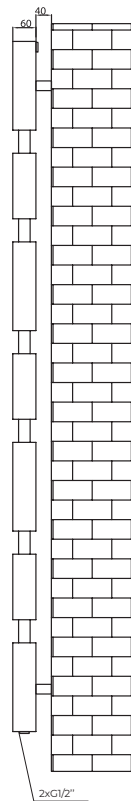

Hydraulic connections/  
Conexiuni hidraulice

Code Cod	Finish Finisaj	Height Înălțime (H)	Length Lățime (L)	Centres Interax (A)	No el Nr elemente	Weight Greutate	Volume Volum	Output / Putere termică (watt)		
								$\Delta t=30^{\circ}\text{C}$	$\Delta t=50^{\circ}\text{C}$	$\Delta t=60^{\circ}\text{C}$
		mm	mm	mm	pcs	kg	l	W	W	W
BELBIG060/179V9010	RAL9010/alb	1790	600	50	7	25,5	13,7	440	847	1059



 Max. working pressure/  
Presiune max. de lucru 5.5 bar

 Max. working temperature/  
Temperatură max. de lucru 90 °C

 Mounting kit included/  
Kit montaj inclus: K06

 Factory pressure test/  
Presiune de probă: 7 bar

 Elements & collectors/  
Elemente și colectori: Ø80x40+40x30 mm



NEW/NOU

# Heaton

HEATON is a linear, clean, rectangular shaped radiator with an optimum thermal output that can fit any room of the house with a fine discretion.

HEATON este un radiator liniar, simplu, de formă dreptunghiulară, cu o putere termică optimă, care se poate potrivi în orice cameră a casei cu o discreție rafinată.

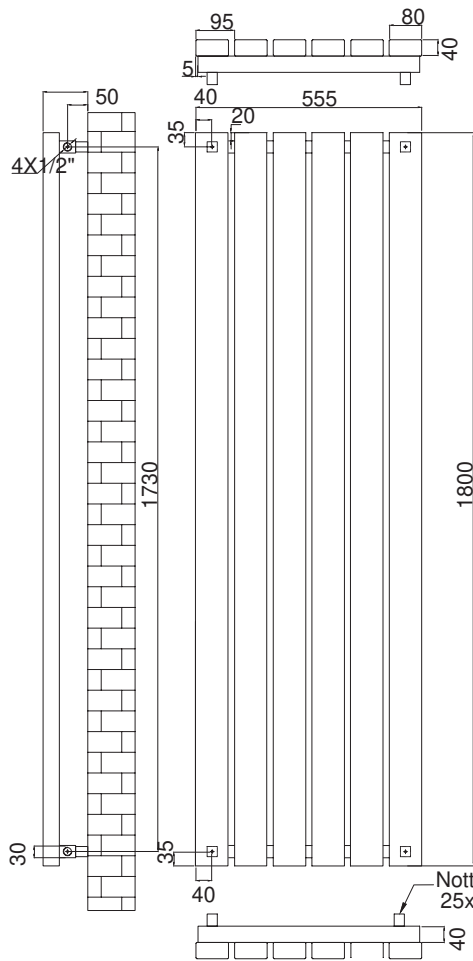

Nott. 20+cons. ec.  
25x25 L=30.

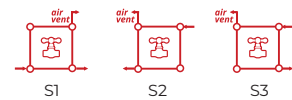
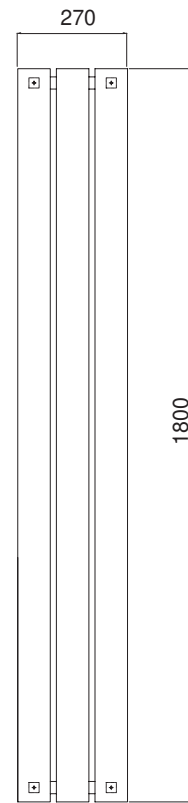



Hydraulic connections/  
Conexiuni hidraulice

Code Cod	Finish Finisaj	Height Înălțime (H)	Length Lățime (L)	Centres Interax (A)	No el Nr ele- menți	Weight Greutate	Volume Volum	Output / Putere termică (watt)			
								$\Delta t=30^{\circ}\text{C}$	$\Delta t=50^{\circ}\text{C}$	$\Delta t=60^{\circ}\text{C}$	electric***
		mm	mm	mm	pcs	kg	l	W	W	W	W
HEAT1800*03V9010	RAL9010/ alb	1800	270	1730	3	15,57	15,92	264	507	634	600
HEAT1800*06V9010		1800	555	1730	6	31,18	31,18	529	1017	1271	1200

\*\*\* The mentioned code is for hydronic version./Codul menționat este pentru versiunea hidraulică.



 Max. working pressure/  
Presiune max. de lucru 7 bar

 Max. working temperature/  
Temperatură max. de lucru 90 °C

 Mounting kit included/  
Kit montaj inclus: K02

 10 bar  
Factory pressure test/  
Presiune de probă: 13 bar

 Elements & collectors/  
Elemente și colectori: Ø35 x 42 mm



# Hendra

With its simple, round linear shape, HENDRA has excellent thermal performance, perfectly integrating into various rooms of the house.

Cu forma sa liniară simplă, rotundă, HENDRA are o putere termică excelentă, integrându-se perfect în diverse încăperi ale casei.

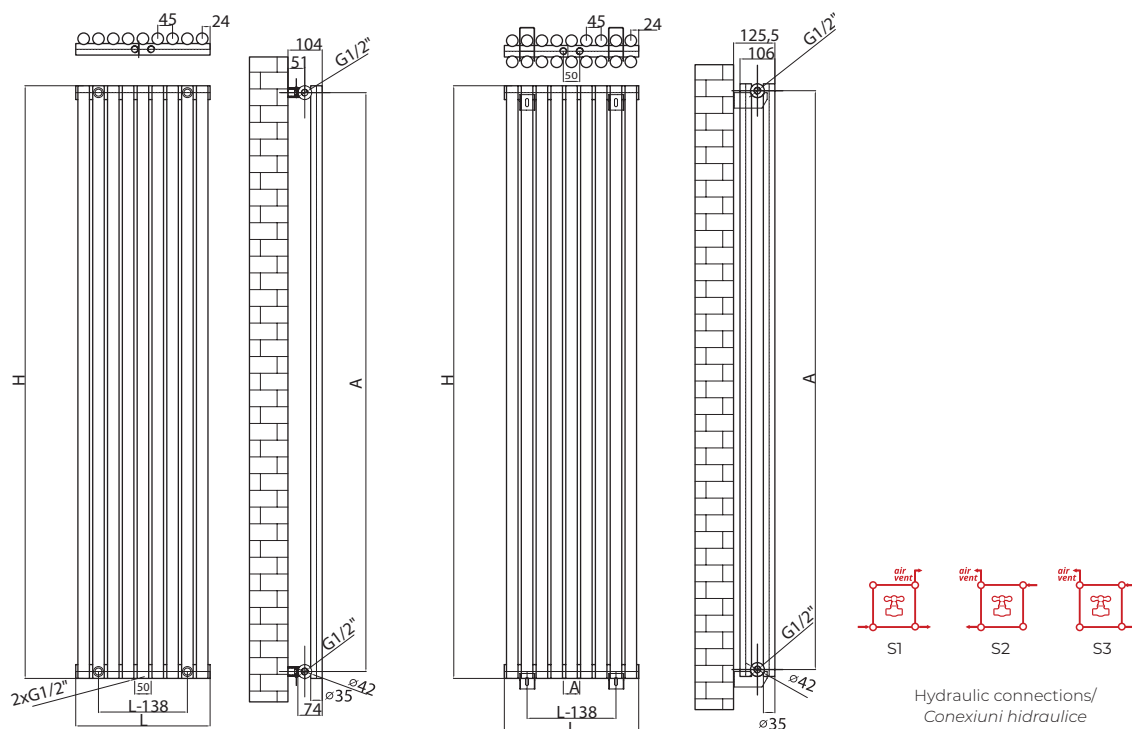

Code Cod	Finish Finisaj	Height Înălțime (H)	Length Lățime (L)	Centres Interax (A)	No el Nr ele- menți	Weight Greutate	Volume Volum	Output / Putere termică (watt)			
								Δt=30°C	Δt=50°C	Δt=60°C	
		mm	mm	mm	pcs	kg	l	W	W	W	
mono	RAL9010 white/alb	HEN600*06V9010	600	273	558	6	6.18	3.55	122	235	294
		HEN600*09V9010	600	408	558	9	9.26	5.32	183	352	440
		HEN600*12V9010	600	543	558	12	12.35	7.08	244	469	586
		HEN1500*06V9010	1500	273	1458	6	12.87	7.89	277	532	665
		HEN1500*09V9010	1500	408	1458	9	19.31	11.83	414	797	996
		HEN1500*12V9010	1500	543	1458	12	25.74	15.77	553	1063	1329
		HEN1800*06V9010	1800	273	1758	6	15.11	9.33	328	631	789
		HEN1800*09V9010	1800	408	1758	9	22.65	14.00	492	946	1183
		HEN1800*12V9010	1800	543	1758	12	30.20	18.66	328	631	789
		HENBI600*12V9010	600	273	558	12	11.54	6.44	225	433	541
		HENBI600*18V9010	600	408	558	18	17.31	9.66	337	649	811
		HENBI600*24V9010	600	543	558	24	23.07	12.87	450	865	1081
bi	RAL9010 white/alb	HENBI1500*12V9010	1500	273	1458	12	24.93	15.12	534	1027	1284
		HENBI1500*18V9010	1500	408	1458	18	37.40	22.68	801	1540	1925
		HENBI1500*24V9010	1500	543	1458	24	49.86	30.23	1068	2053	2566
		HENBI1800*12V9010	1800	273	1758	12	29.40	18.01	637	1225	1531
		HENBI1800*18V9010	1800	408	1758	18	44.09	27.02	955	1837	2296
		HENBI1800*24V9010	1800	543	1758	24	58.79	36.02	1273	2449	3061



Max. working pressure/  
Presiune max. de lucru 5.5 bar



Max. working temperature/  
Temperatură max. de lucru 90 °C



Mounting kit included/  
Kit montaj inclus: K08



Factory pressure test/  
Presiune de probă: 7 bar



Elements&collectors/  
Elementi și colectori: Ø70x11 mm

NEW/NOU

# King 20

KING 20 with its thin square tubes laid in two rows is a reliable choice for any heating system, providing a large surface area for the transfer of heat, which allows the radiator to generate a high output of heat and warm the surrounding area quickly and efficiently.

KING 20, cu elementii săi pătrați și înguști așezați pe două rânduri, este o alegere fiabilă pentru orice sistem de încălzire, oferind o suprafață mare pentru transferul de căldură, ceea ce permite radiatorului să genereze o putere mare de căldură și să încălzească camera rapid și eficient.

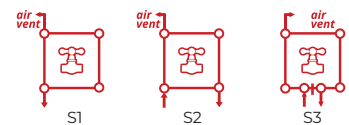
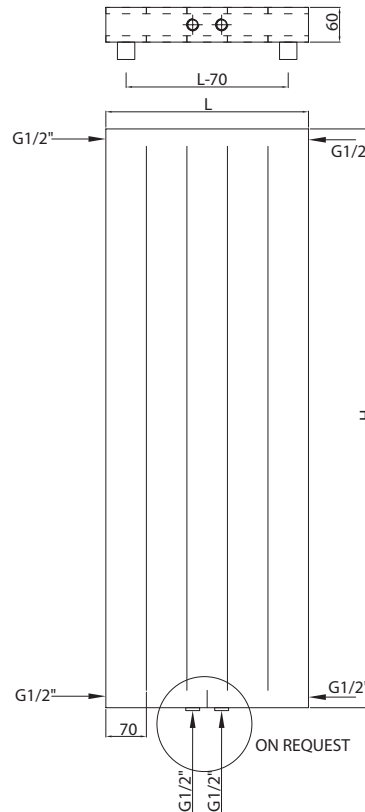
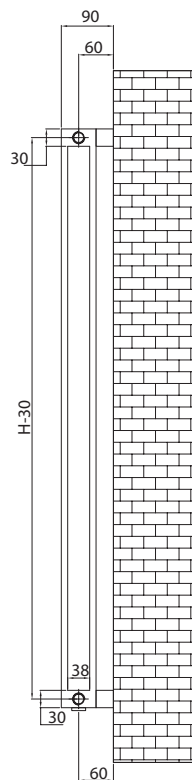



Hydraulic connections/Conexiuni hidraulice

Code Cod	Finish Finisaj	Height Înălțime (H)	Length Lățime (L)	Centres Interax (A)	No el Nr elemente	Weight Greutate	Volume Volum	Output / Putere termică (watt)		
								$\Delta t=30^{\circ}\text{C}$	$\Delta t=50^{\circ}\text{C}$	$\Delta t=60^{\circ}\text{C}$
		mm	mm	mm	pcs	kg	l	W	W	W
PK20/280/1200V9010FAGV	RAL9010 white/alb	1200	280	210	8	19.38	6.00	431	828	1035
PK20/420/1200V9010FAGV		1200	420	350	12	20.14	7.29	532	1,022	1278
PK20/630/1200V9010FAGV		1200	630	540	18	21.28	8.58	633	1,217	1521
PK20/280/1500V9010FAGV		1500	280	210	8	35.02	9.01	646	1,242	1553
PK20/420/1500V9010FAGV		1500	420	350	12	35.77	10.94	797	1,534	1917
PK20/630/1500V9010FAGV		1500	630	540	18	36.91	16.41	949	1,825	2281
PK20/280/1800V9010FAGV		1800	280	210	8	61.81	13.52	969	1,863	2329
PK20/420/1800V9010FAGV		1800	420	350	12	62.57	16.41	1,196	2,300	2876
PK20/630/1800V9010FAGV		1800	630	540	18	63.71	19.30	1,424	2,738	3423



 Max. working pressure/  
Presiune max. de lucru 7 bar

 Max. working temperature/  
Temperatură max. de lucru 90 °C

 Mounting kit included/  
Kit montaj inclus

 **10** bar Factory pressure test/  
Presiune de probă: 10 bar

 Elements & collectors/  
Elemente și colectori: Ø60x30 mm

**NEW/NOU**

# Piglet

PIGLET, a robust floor-mounted designer radiator, is ideal for low window sills, but it can be placed almost anywhere. Available in various finishes, including color combinations and chrome, PIGLET has efficient heat output, and the chrome plated version is a standout choice.

PIGLET, un radiator de design robust montat pe podea, este ideal pentru camere cu ferestre mari, insa poate fi plasat oriunde. Disponibil în diverse finisaje, inclusiv combinații de culori și crom, PIGLET are putere termica mare, iar varianta cromată, este o alegere remarcabilă.

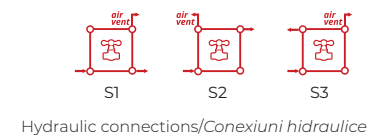
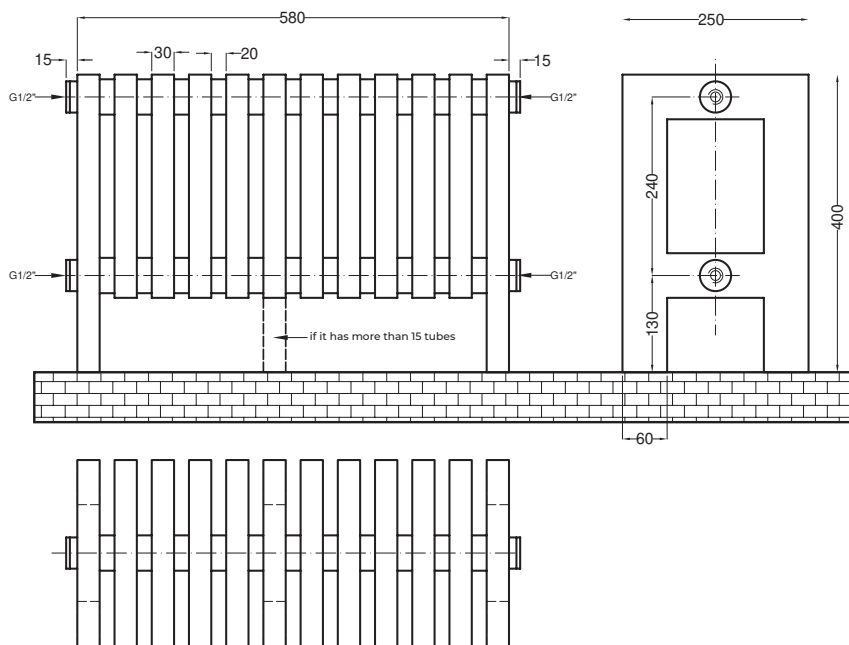

Hydraulic connections/Conexiuni hidraulice

Code Cod	Finish Finisaj	Height Înălțime (H) mm	Length Lățime (L) mm	No el Nr ele- menți pcs	Weight Greutate kg	Volume Volum l	Output / Putere termică (watt)			
							$\Delta t=30^{\circ}\text{C}$ W	$\Delta t=50^{\circ}\text{C}$ W	$\Delta t=60^{\circ}\text{C}$ W	electric*** W
PG30N12V9010	RAL9010 white/alb	400	600	12	23,9	16,9	465	1206	1508	1000
PG30N14V9010		400	700	14	27,8	19,6	770	1481	1852	1000
PG30N16V9010		400	800	16	31,6	22,3	926	1781	2226	1500
PG30N18V9010		400	900	18	35,4	25	1094	2104	2630	1500
PG30N12CR	Chrome/cromat	400	600	12	23,9	16,9	483	928	1160	1000
PG30N14CR		400	700	14	27,8	19,6	593	1140	1425	1000
PG30N16CR		400	800	16	31,6	22,3	712	1370	1712	1500
PG30N18CR		400	900	18	35,4	25	842	1618	2023	1500

\*\*\*\*\* The mentioned code is for hydronic version./Codul menționat este pentru versiunea hidraulică.



 Max. working pressure/  
Presiune max. de lucru 10 bar

 Max. working temperature/  
Temperatură max. de lucru 90 °C

 Mounting kit included/  
Kit montaj inclus: K03

 10 bar Factory pressure test/  
Presiune de probă: 13 bar

 Elements & collectors/  
Elemente și colectori: Ø89+40x30mm



NEW/NOU

# Aramis 2



ARAMIS 2 is a sleek and modern heating solution that adds both style and functionality to any room. Its large horizontal tubes are open at both ends, providing ample space for towels to be warmed, while providing efficient heat distribution.

ARAMIS 2 este o soluție de încălzire elegantă și modernă, care adăuga stil și funcționalitate oricărei încăperi. Tuburile orizontale mari sunt deschise la ambele capete, oferind spațiu amplu pentru încălzirea prosoapelor, oferind în același timp o distribuție eficientă a căldurii.

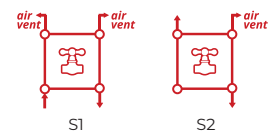
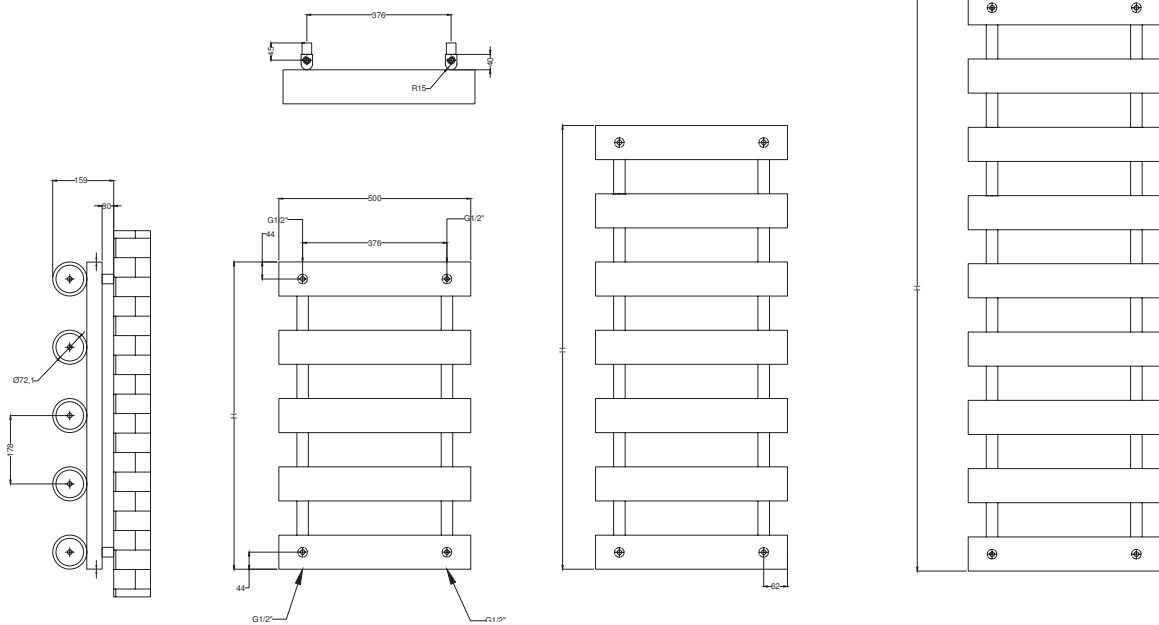

Hydraulic connections/Conexiuni hidraulice

Code Cod	Finish Finisaj	Height Înălțime (H) mm	Length Lățime (L) mm	Centres Interax (A) mm	No of Nr ele- menți pcs	Weight Greutate kg	Volume Volum l	Output / Putere termică (watt)			
								$\Delta t=30^{\circ}\text{C}$ W	$\Delta t=50^{\circ}\text{C}$ W	$\Delta t=60^{\circ}\text{C}$ W	electric*** W
AR2050/080V9010	RAL9010 white/alb	800	500	376	5	21,3	5,2	380	731	914	900
AR2050/115.5V9010		1155	500	376	7	30	7,4	534	1027	1284	900
AR2050/151.2V9010		1512	500	376	9	38,6	9,5	688	1323	1654	1200

\*\*\*\*\* The mentioned code is for hydronic version./Codul menționat este pentru versiunea hidraulică.



 Max. working pressure/  
Presiune max. de lucru 10 bar

 Max. working temperature/  
Temperatură max. de lucru 90 °C

 Mounting kit included/  
Kit montaj inclus: K04/12

 Factory pressure test/  
Presiune de probă: 13 bar

 Elements & collectors/  
Elemente și colectori: Ø18x35 mm

NEW/NOU

# Bliss

BLISS may seem simple, but it's meticulously crafted for optimal heating. This flat towel rail, available in various finishes, features a standard design made from premium steel. The ROUND variant provides additional space for towels to dry and warm effectively.

BLISS pare un model simplu, dar a fost proiectat cu grija pentru o eficiență termică optimă. Oferă un design standard de port-prosoap, disponibil în diverse finisaje, inclusiv versiunea ROUND ce oferă spațiu suplimentar pentru uscare și încălzirea prosoapelor.

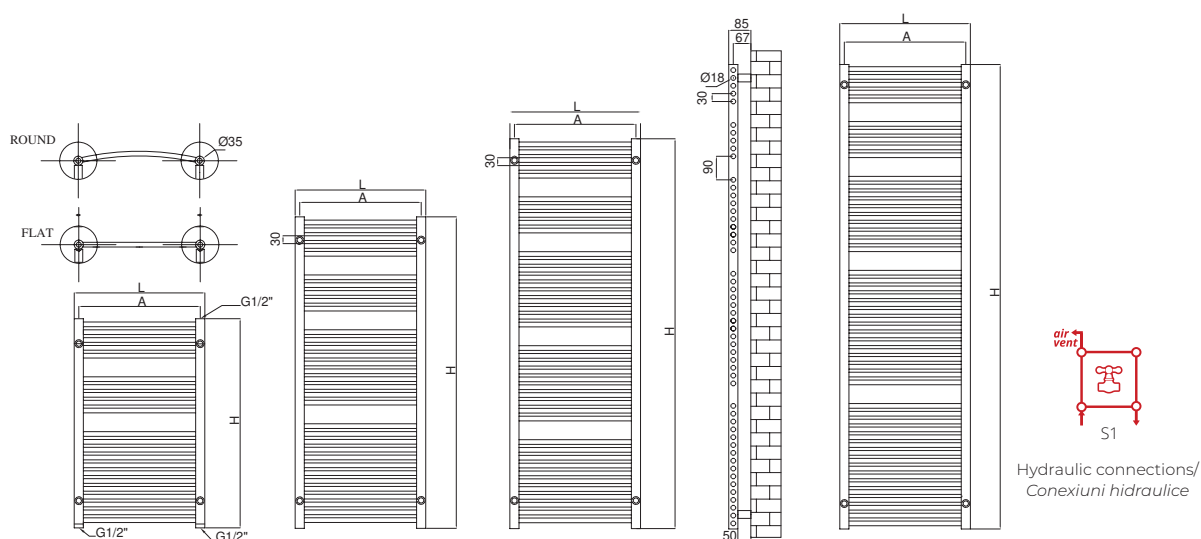



Code/ Cod	Finish / Finisaj	Height/ Înălțime (H)	Length/ Lățime (L)	Centres/ Interax (A)	No el/Nr elementi	Weight/ Greutate	Volume/ Volum	OUTPUT/PUTERE TERMICĂ (watt)		
								Δt=30°C	Δt=50°C	Δt=60°C
		mm	mm	mm	pcs	kg	l	W	W	W
SUNIT050/080V9010	RAL 9010 white/alb*	801	500	465	22	6.00	3.20	196	375	469
SUNIT060/080V9010		801	600	565	22	7.00	3.40	231	440	550
SUNIT050/120V9010		1193	500	465	33	9.00	4.80	294	561	701
SUNIT060/120V9010		1193	600	565	33	10.40	5.50	345	659	823
SUNIT050/180V9010		1779	500	465	51	13.80	7.40	450	859	1073
SUNIT060/180V9010		1779	600	565	51	16.00	8.40	529	1010	1262
SUNIT050/080CR	Chrome / Cromat	801	500	465	22	6.00	3.20	151	288	361
SUNIT060/080CR		801	600	565	22	7.00	3.40	177	339	423
SUNIT050/120CR		1193	500	465	33	9.00	4.80	226	431	539
SUNIT060/120CR		1193	600	565	33	10.40	5.50	266	507	633
SUNIT050/180CR		1779	500	465	51	13.80	7.40	346	661	826
SUNIT060/180CR		1779	600	565	51	16.00	8.40	407	777	971
SUNIT050/080X	Stainless steel /INOX	801	500	465	22	6.00	3.20	146	278	347
SUNIT060/080X		801	600	565	22	7.00	3.40	171	326	408
SUNIT050/120X		1193	500	465	33	9.00	4.80	218	415	519
SUNIT060/120X		1193	600	565	33	10.40	5.50	256	488	610
SUNIT050/180X		1779	500	465	51	13.80	7.40	333	636	795
SUNIT060/180X		1779	600	565	51	16.00	8.40	392	748	935



 Max. working pressure/  
Presiune max. de lucru 10 bar

 Max. working temperature/  
Temperatură max. de lucru 90 °C

 Mounting kit included/  
Kit montaj inclus: K07

 Factory pressure test/  
Presiune de probă: 13 bar

 Elements & collectors/  
Elemente și colectori: Ø 40x30+35 mm



# Empire Tosca 20

EMPIRE TOSCA 20 offers versatile, attractive, and comforting warmth, making it perfect for bathrooms or utility rooms. Its notable advantage lies in efficient towel drying without impeding room heating convection, ensuring optimal performance and comfort.

Cu o putere mare de încălzire, EMPIRE TOSCA 20 este combinația ideală de versatilitate, atracție și confort termic perfect pentru orice camera de baie. Avantajul său major este că uscarea prosoapelor nu încetinește convecția aerului pentru încălzirea camerei.

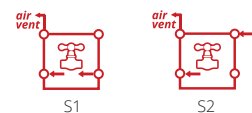
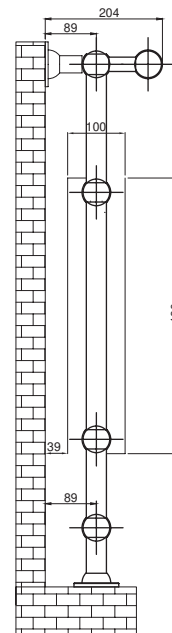
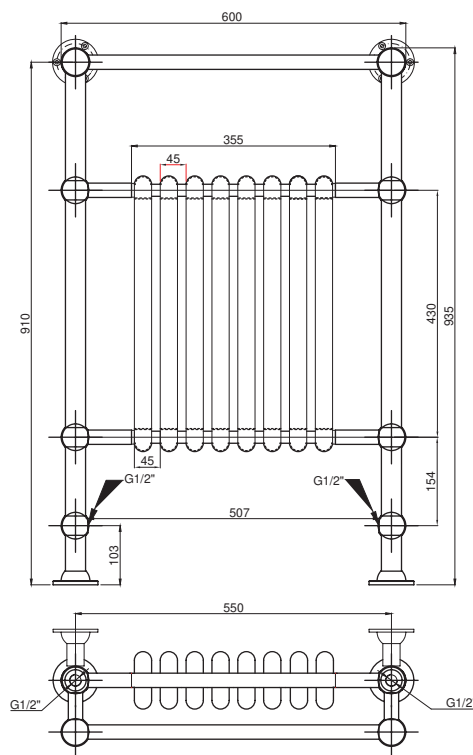

Hydraulic connections/  
Conexiuni hidraulice

Code Cod	Finish Finisaj	Height Înălțime (H) mm	Length Lățime (L) mm	Centres Interax (A) mm	No of Nr elemente pcs	Weight Greutate kg	Volume Volum l	Output / Putere termică (watt)		
								$\Delta t=30^{\circ}\text{C}$ W	$\Delta t=50^{\circ}\text{C}$ W	$\Delta t=60^{\circ}\text{C}$ W
EMMT060/093CRT480*08V9010	RAL 9010 + chrome	935	600	507	8	14.75	9.8	320	615	769



Max. working pressure/  
Presiune max. de lucru 10 bar



Max. working temperature/  
Temperatură max. de lucru 90 °C



Mounting kit included/  
Kit montaj inclus: KT2



Factory pressure test/  
Presiune de probă: 13 bar



Elements&collectors/  
Elemente și colectori: Ø22+38 mm

NEW/NOU

# Premier XL Space

Premier XL Space is a functional and stylish solution designed to add warmth and practicality in any bathroom. The durable stainless-steel construction and clean aesthetic make it an attractive option, with good output, complementing any range of interior design styles.

Premier XL Space reprezintă o soluție practică și elegantă, menită să aducă căldură și funcționalitate în orice baie. Construcția solidă din inox și designul curat îl fac o opțiune atrăgătoare, cu o eficiență termică ridicată, potrivindu-se oricărui stil de design interior.

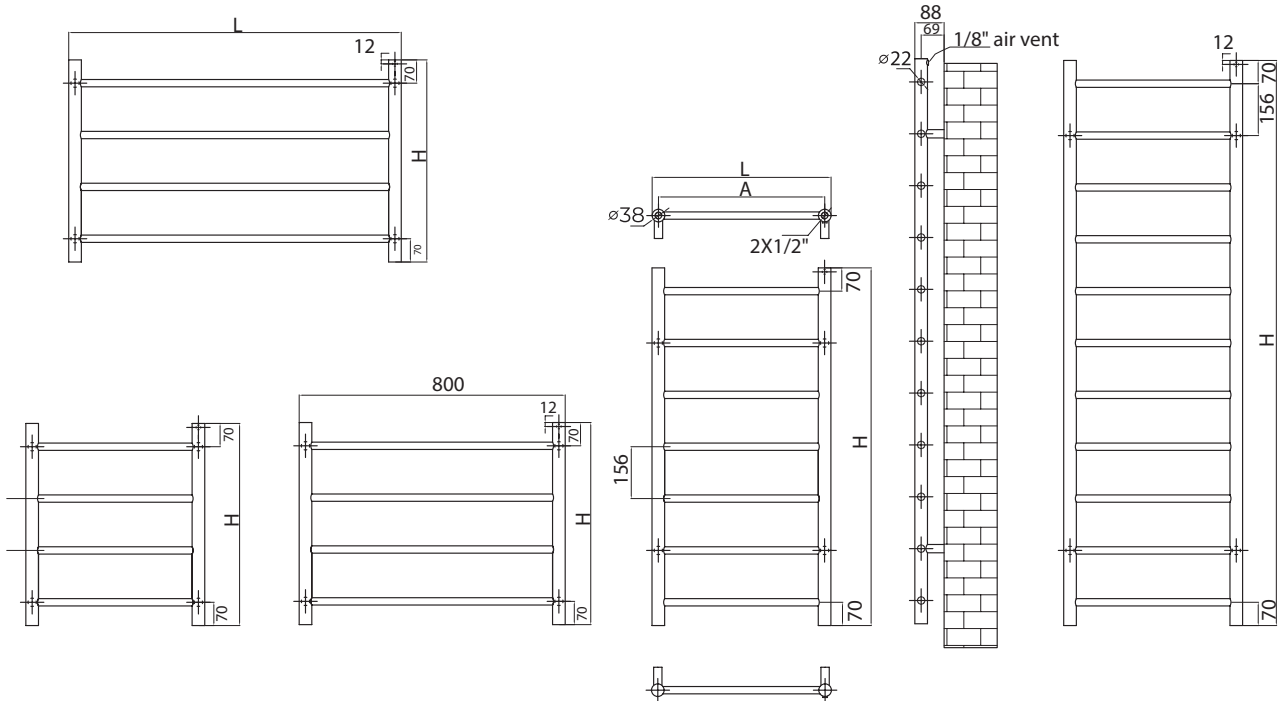

Hydraulic connections/  
Conexiuni hidraulice

Code Cod	Finish Finisaj	Height Înălțime (H)	Length Lățime (L)	Centres Interax (A)	No el Nr ele- menți	Weight Greutate	Volume Volum	Output / Putere termică (watt)			
								$\Delta t=30^{\circ}\text{C}$	$\Delta t=50^{\circ}\text{C}$	$\Delta t=60^{\circ}\text{C}$	electric
		mm	mm	mm	pcs	kg	l	W	W	W	W
PREMBS053.8/060.8X	stainless steel/inox	608	538	500	4	3,158	1,61	55	105	131	300
PREMBS080/060.8X		608	800	762	4	3,952	1,99	69	132	165	300
PREMBS100/060.8X		608	1000	962	4	4,56	2,24	79	152	190	300
PREMBS053.8/107.6X		1076	538	500	7	5,56	2,83	96	185	231	500
PREMBS053.8/170X		1700	538	500	11	8,76	4,46	151	291	364	500

\*\*\*\*\* The mentioned code is for hydronic version./Codul menționat este pentru versiunea hidraulică.



Max. working pressure/  
Presiune max. de lucru 10 bar



Max. working temperature/  
Temperatură max. de lucru 90 °C



Mounting kit included/  
Kit montaj inclus: KT2



Factory pressure test/  
Presiune de probă: 13 bar



Elements & collectors/  
Elemente și colectori: Ø22+38 mm



NEW/NOU

# Polter



POLTER has a clean and compact design, with elements arranged rhythmically and welded to the 2 vertical collectors. In addition to its heating capabilities, POLTER also serves as a practical and convenient way to dry and warm towels.

POLTER are un design curat si compact, cu elementii orizontali dispusi ritmic si sudati intre cei 2 colectori verticali. Pe lângă eficiența sa de a încălzi spații, POLTER servește și ca o modalitate practică și convenabilă de a usca și încălzi prosoapele

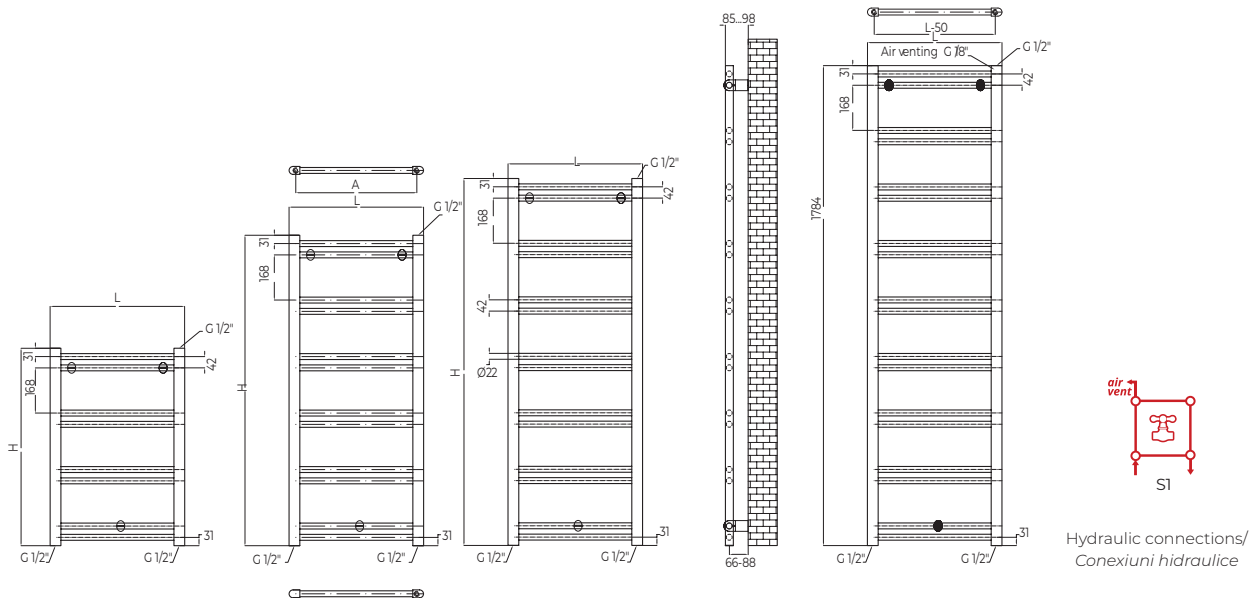

Code Cod	Finish Finisaj	Height Înălțime (H)	Length Lățime (L)	Centres Interax (A)	No of Nr elementi	Weight Greutate	Volume Volum	Output / Putere termică (watt)			
								Δt=30°C	Δt=50°C	Δt=60°C	electric
		mm	mm	mm	pcs	kg	l	W	W	W	W
POL040/073.4V9010	RAL 9010 white/alb	734	400	350	8	4.52	2.26	120	232	289	300
POL050/073.4V9010		734	500	450	8	5.13	2.49	138	266	333	300
POL060/073.4V9010		734	600	550	8	5.73	2.71	156	301	376	300
POL040/115.4V9010		1154	400	350	12	6.93	3.49	177	340	327	500
POL050/115.4V9010		1154	500	450	12	7.84	3.83	202	389	486	500
POL060/115.4V9010		1154	600	550	12	8.75	4.17	227	437	545	500
POL040/136.4V9010		1364	400	350	14	8.13	4.10	220	422	528	600
POL050/136.4V9010		1364	500	450	14	9.19	4.50	252	484	605	600
POL060/136.4V9010		1364	600	550	14	10.26	4.89	284	547	683	600
POL040/073.4CR		Chrome / Cromat	734	400	350	8	4.52	2.26	93	178	223
POL050/073.4CR	734		500	450	8	5.13	2.49	106	205	256	300
POL060/073.4CR	734		600	550	8	5.73	2.71	120	231	289	300
POL040/115.4CR	1154		400	350	12	6.93	3.49	130	262	327	500
POL050/115.4CR	1154		500	450	12	7.84	3.83	155	299	374	500
POL060/115.4CR	1154		600	550	12	8.75	4.17	175	336	419	500
POL040/136.4CR	1364		400	350	14	8.13	4.10	169	325	406	600
POL050/136.4CR	1364		500	450	14	9.19	4.50	194	373	466	600
POL060/136.4CR	1364		600	550	14	10.26	4.89	219	420	525	600

\*\*\*\*\* The mentioned code is for hydronic version./Codul menționat este pentru versiunea hidraulică.



# ARENA

Valves are not included and must be ordered separately, if required.  
*Robineții nu sunt incluși și trebuie comandați separat, la cerere.*



# ARENA

Perfect proportions, shape and function, these are the key worlds of ARENA. With rectangular sections, full balance of the shape, ARENA becomes the focus point of each room, while producing a good heat output.

Proportii perfecte, forma și utilitate, acestea sunt cuvintele cheie ale radiatorului ARENA. Cu secțiunile sale rectangulare, ARENA devine centrul atenției din orice cameră, beneficiind și de o putere termică bună.

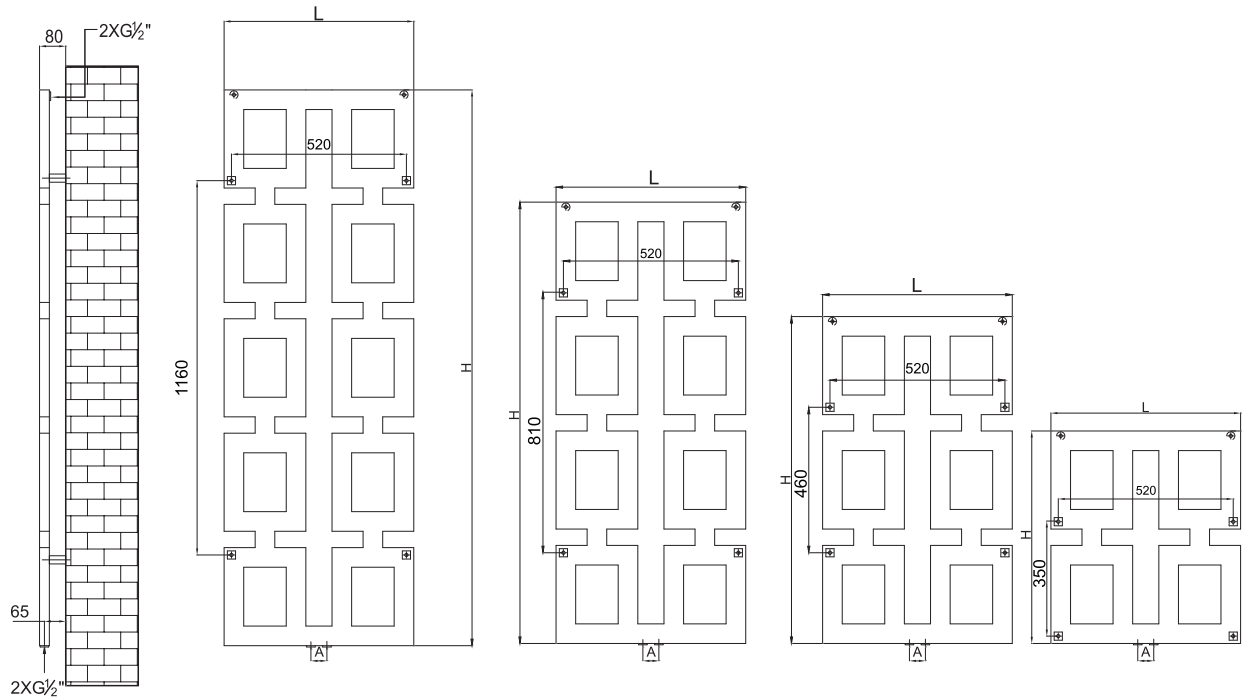

Max. working pressure/  
Presiune max. de lucru 7 bar



Max. working temperature/  
Temperatură max. de lucru 90°C



Mounting kit included/  
Kit montaj inclus: K06 page 203



Factory pressure test/  
Presiune de probă: 10 bar



Elements & collectors/  
Elemente și colectori: 60x30mm

Code/ Cod	Finish / Finisaj	Height/ Înălțime (H)	Length/ Lățime (L)	Centres/ Interax (A)	No el/Nr elemente	Weight/ Greutate	Volume/ Volum	OUTPUT/PUTERE TERMICĂ (watt)			
								Δt=30°C	Δt=50°C	Δt=60°C	electric***
		mm	mm	mm	pcs	kg	l	W	W	W	W
AR058/065V9010AC		650	580	50	4	8,00	6,00	164	315	394	300
AR058/100V9010AC	RAL 9010 white/ alb*	1000	580	50	6	11,90	8,90	245	471	588	600
AR058/135V9010AC		1350	580	50	8	15,80	11,90	326	626	783	600
AR058/170V9010AC		1700	580	50	10	19,80	14,90	406	782	977	800

● We can make custom dimensions, after technical analysis. | Putem executa dimensiuni speciale, în urma unei analize tehnice.  
The mentioned code is for hydronic version. | Codul menționat este pentru versiunea hidraulică.

Hydraulic connections/  
Conexiuni hidraulice\*\*



S1 for ARENA

Electric connections/  
Conexiuni electrice\*\*\*



S2 for INKA

\* For other colours, put your desired RADOX colour code instead of 9010 (standard white). For more details, see page 194  
Pentru alte culori, se pune codul culorii RADOX dorite în locul codului 9010 (standard alb). Mai multe detalii la pag. 194

\*\* When you order, you must mention the type of connection you require. The price changes according to the requirements.  
Când comandați trebuie să menționați tipul de alimentare necesar. Prețul se modifică în funcție de cerințe.

\*\*\* INKA is the electric version of ARENA, please order accordingly.  
INKA este versiunea electrică a radiatorului ARENA, motiv pentru care trebuie să îl comandați sub acest nume.



# BROC

Valves are not included and must be ordered separately, if required.  
*Robineții nu sunt incluși și trebuie comandați separat, la cerere.*

# BROC

An attractive radiator set apart from the heating tradition, BROC is a unique piece of craftsmanship. Outrageously powerful in both visual effect and functionality, BROC is available in all RAL colours, chrome plated or stainless steel.

*Un radiator atractiv și neconvențional, BROC este o îmbinare perfectă de inginerie și creativitate. Puternic atât în efectul vizual creat, cât și în funcționalitate, BROC este disponibil în orice culoare RAL, cromat sau din inox.*

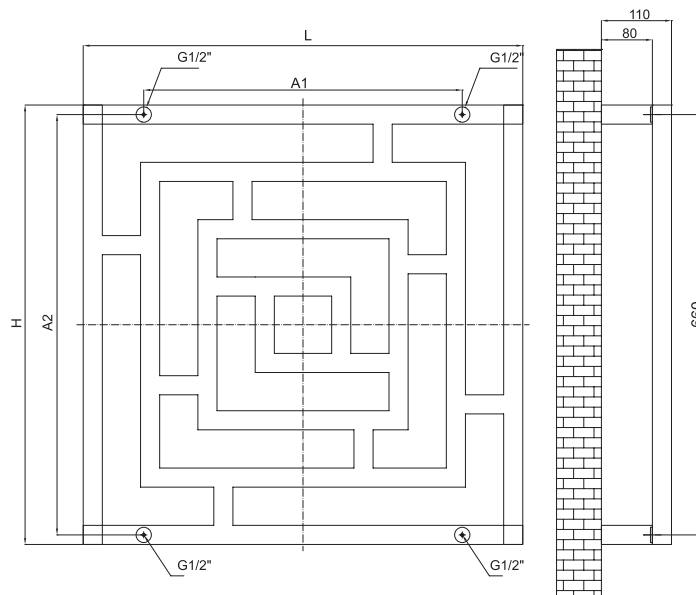

Max. working pressure/  
Presiune max. de lucru 10 bar



Max. working temperature/  
Temperatură max. de lucru 90°C



Mounting kit included/  
Kit montaj inclus: K06 page 203



Factory pressure test/  
Presiune de probă: 13 bar



Elements/Elemente:  
30x30mm

Code/ Cod	Finish / Finisaj	Height/ Înălțime (H)	Length/ Lățime (L)	Centres/ Interax (A)	No el/Nr elemente	Weight/ Greutate	Volume/ Volum	OUTPUT/PUTERE TERMICĂ (watt)		
								Δt=30°C	Δt=50°C	Δt=60°C
		mm	mm	mm	pcs	kg	l	W	W	W
BROCP069/069V9010	RAL 9010 white/alb*	690	690	500	660	9,20	5,00	207	394	493
BROCP069/069CR	Chrome / Cromat	690	690	500	660	9,20	5,00	159	303	379
BROCP069/069INOX	Stainless steel /INOX	690	690	500	660	9,20	5,00	153	292	365

● We can make custom dimensions, after technical analysis. | Putem executa dimensiuni speciale, în urma unei analize tehnice.

Hydraulic connections/  
Conexiuni hidraulice\*\*

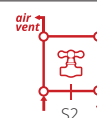

\* For other colours, put your desired RADOX colour code instead of 9010 (standard white). For more details, see page 194  
Pentru alte culori, se pune codul culorii RADOX dorite în locul codului 9010 (standard alb). Mai multe detalii la pag. 194

\*\* When you order, you must mention the type of connection you require. The price changes according to the requirements.  
Când comandați trebuie să menționați tipul de alimentare necesar. Prețul se modifică în funcție de cerințe.



# CENTO 15

Valves are not included and must be ordered separately, if required.  
*Robineții nu sunt incluși și trebuie comandați separat, la cerere.*



# CENTO 15

This stylish steel radiator comes in a timeless classic design, equally looking fantastic in modern environments or traditional houses. CENTO 15 features rectangular steel columns that really give the radiator its powerful, yet very attractive appearance. Available in vertical (Cento 15) or horizontal version (Cento 15 H).

Acest elegant radiator de oțel vine cu un design atemporal clasic, arătând la fel de fantastic în ambiente moderne sau în case tradiționale. CENTO 15 are coloane de oțel dreptunghiulare care dau radiatorului aspectul unui produs puternic și extrem de atractiv. Disponibil în versiune verticală (Cento 15) sau orizontală (Cento 15 H).

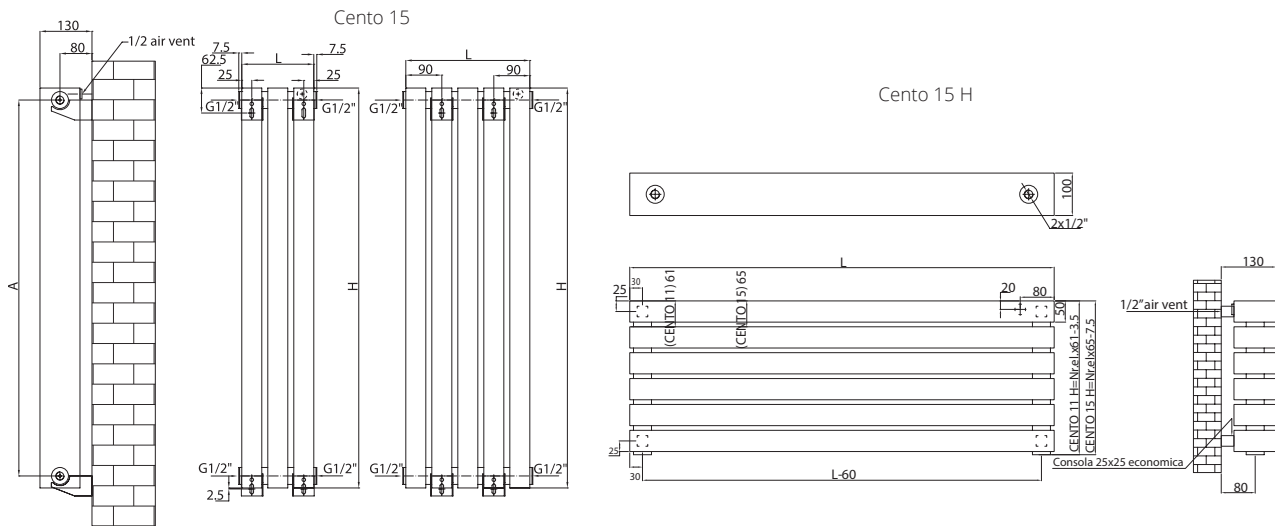
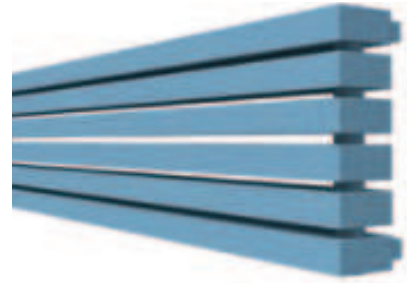

Max. working pressure/  
Presiune max. de lucru 7 bar



Max. working temperature/  
Temperatură max. de lucru 90°C



Mounting kit included/  
Kit montaj inclus: K23 page 203



Factory pressure test/  
Presiune de probă: 10 bar



Elements/Elemente:  
50x100mm

	Code/ Cod	Finish / Finisaj	Height/ Înălțime (H)	Length/ Lățime (L)	Centres/ Interax (A)	No el/Nr elemente	Weight/ Greutate	Volume/ Volum	OUTPUT/PUTERE TERMICĂ (watt)		
									Δt=30°C	Δt=50°C	Δt=60°C
			mm	mm	mm	pcs	kg	l	W	W	W
Cento 15 H	CEH1000*06V9010	RAL 9010 white/alb*	375	1000	940	6	28,80	26,70	485	926	1157
	CEH1300*06V9010		375	1300	1240	6	37,10	34,60	627	1196	1495
	CEH1500*06V9010		375	1500	1440	6	42,60	39,90	721	1376	1720
Cento 15	CEN1800*03V9010	RAL 9010 white/alb*	1800	180	1740	3	25,40	23,90	431	823	1029
	CEN1800*05V9010		1800	310	1740	5	42,30	39,90	719	1372	1715
	CEN1800*07V9010		1800	440	1740	7	59,30	55,80	1006	1920	2400
	CEN2000*03V9010		2000	180	1940	3	28,10	26,60	479	913	1142
	CEN2000*05V9010		2000	310	1940	5	46,90	44,30	797	1522	1902
	CEN2000*07V9010		2000	440	1940	7	65,70	62,00	1116	2130	2663

● We can make custom dimensions, after technical analysis. | Putem executa dimensiuni speciale, în urma unei analize tehnice.

Hydraulic connections  
for vertical version/  
Conexiuni hidraulice  
versiune verticală\*\*

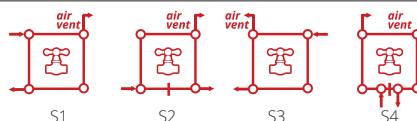

Hydraulic connections  
for horizontal version/  
Conexiuni hidraulice  
versiune orizontală\*\*



\* For other colours, put your desired RADOX colour code instead of 9010 (standard white). For more details, see page 194  
Pentru alte culori, se pune codul culorii RADOX dorite în locul codului 9010 (standard alb). Mai multe detalii la pag. 194

\*\* When you order, you must mention the type of connection you require. The price changes according to the requirements.  
Când comandați trebuie să menționați tipul de alimentare necesar. Prețul se modifică în funcție de cerințe.



# CIRCLE

Valves are not included and must be ordered separately, if required.  
*Robineții nu sunt incluși și trebuie comandați separat, la cerere.*







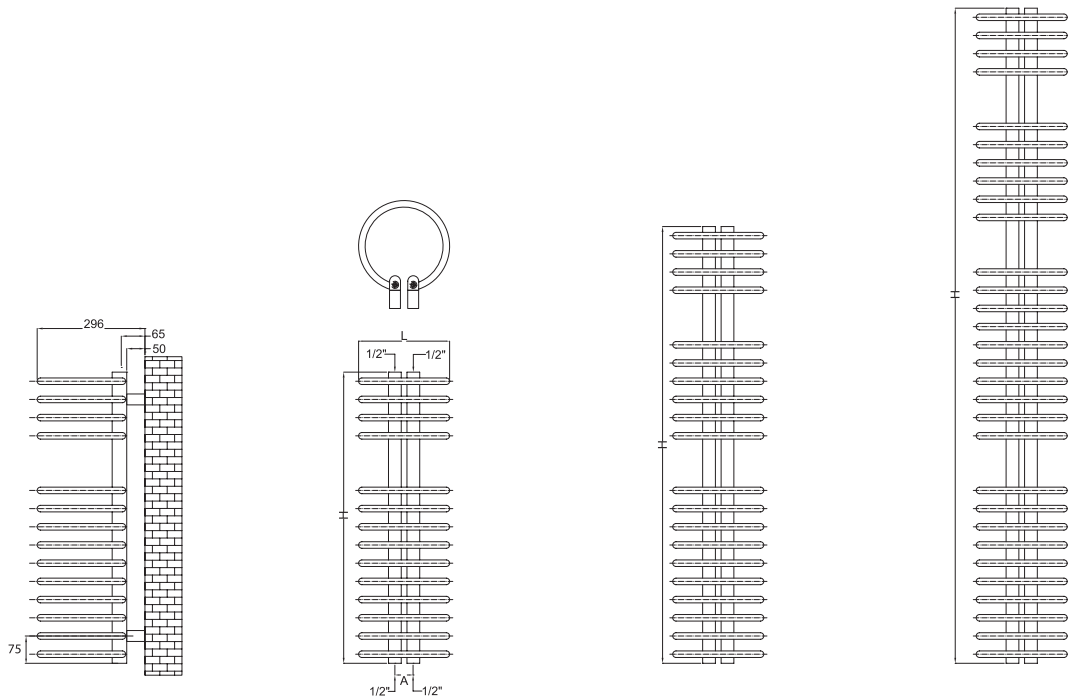

# CIRCLE

This stunning radiator is much more than just a heating element. With exceptional heat output CIRCLE boasts extensive functional utility. Our clever space-saving radiator can fit in any corner of a kitchen or bathroom. Its rings are spaced as such to allow towels to hang within the center of the radiator.

Acest superb radiator este mai mult decât un simplu element de încălzire. Designul ergonomic permite montarea în orice colț din bucătărie sau baie, atunci când nu există mult spațiu la dispoziție. CIRCLE este disponibil în orice culoare RAL, iar spațiul generos între inele permite depozitarea și încălzirea optimă a prosoapelor.



											
Max. working pressure/ Presiune max. de lucru 10 bar	Max. working temperature/ Temperatură max. de lucru 90°C	Mounting kit included/ Kit montaj inclus: K03 page 203	Factory pressure test/ Presiune de probă: 13 bar	Elements/ Elemente: Ø18mm	Collectors/ Colectori: 40x30mm						
Code/ Cod	Finish / Finisaj	Height/ Înălțime (H)	Length/ Lățime (L)	Centres/ Interax (A)	No el/Nr elemente	Weight/ Greutate	Volume/ Volum	OUTPUT/PUTERE TERMICĂ (watt)			
								Δt=30°C	Δt=50°C	Δt=60°C	electric
		mm	mm	mm	pcs	kg	l	W	W	W	W
CI025/080V9010		800	250	50	14	6,30	3,30	224	427	534	500
CI025/120V9010	RAL 9010 white/alb*	1200	250	50	20	9,00	4,80	324	618	773	600
CI025/180V9010		1800	250	50	30	13,50	7,20	485	926	1158	1200

 We can make custom dimensions, after technical analysis. | Putem executa dimensiuni speciale, în urma unei analize tehnice.  
The mentioned code is for hydronic version. | Codul menționat este pentru versiunea hidraulică.

Hydraulic connections/  
Conexiuni hidraulice\*\*



\* For other colours, put your desired RADOX colour code instead of 9010 (standard white). For more details, see page 194  
Pentru alte culori, se pune codul culorii RADOX dorite în locul codului 9010 (standard alb). Mai multe detalii la pag. 194

\*\* When you order, you must mention the type of connection you require. The price changes according to the requirements.  
Când comandați trebuie să menționați tipul de alimentare necesar. Prețul se modifică în funcție de cerințe.



# COMBI

Valves are not included and must be ordered separately, if required.  
*Robineții nu sunt incluși și trebuie comandați separat, la cerere.*



# COMBI

Finished in a sleek chrome or in any combination of colours and chrome, COMBI is both practical and lovingly designed. Very suitable for kitchens and bathrooms alike, this superb design fits every interior.

COMBI are un design practic și atractiv, disponibil în orice culoare RAL, cromat sau chiar în combinații de culori și crom, datorită celor doi elemente niplabili. Foarte potrivit atât pentru bucătărie, cât și pentru baie, acest model splendid se armonizează oricărui interior.

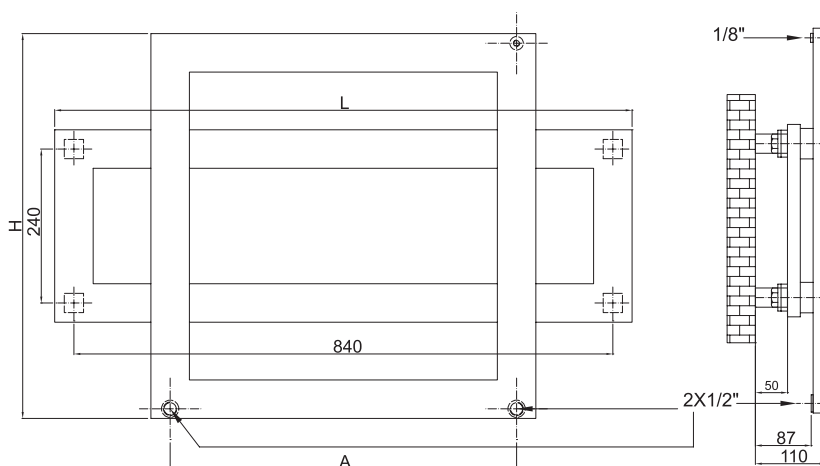

Max. working pressure/  
Presiune max. de lucru 5.5 bar



Max. working temperature/  
Temperatură max. de lucru 90°C



Mounting kit included/  
Kit montaj inclus: K06 page 203



Factory pressure test/  
Presiune de probă: 7 bar



Elements/  
Elemente: 60x20mm

Code/ Cod	Finish / Finisaj	Height/ Înălțime (H)	Length/ Lățime (L)	Centres/ Interax (A)	No el/Nr elemente	Weight/ Greutate	Volume/ Volum	OUTPUT/PUTERE TERMICĂ (watt)		
								Δt=30°C	Δt=50°C	Δt=60°C
		mm	mm	mm	pcs	kg	l	W	W	W
CB090/060V9010	RAL 9010 white/alb*	600	900	540	2	10,50	3,90	181	345	430
CB090/060CR	Chrome / Cromat	600	900	540	2	10,50	3,90	139	265	331

☛ We can make custom dimensions, after technical analysis. | Putem executa dimensiuni speciale, în urma unei analize tehnice.

Hydraulic connections/  
Conexiuni hidraulice\*\*



\* For other colours, put your desired RADOX colour code instead of 9010 (standard white). For more details, see page 194  
Pentru alte culori, se pune codul culorii RADOX dorite în locul codului 9010 (standard alb). Mai multe detalii la pag. 194

\*\* When you order, you must mention the type of connection you require. The price changes according to the requirements.  
Când comandați trebuie să menționați tipul de alimentare necesar. Prețul se modifică în funcție de cerințe.



# COMBI GLASS

Valves are not included and must be ordered separately, if required.  
*Robineții nu sunt incluși și trebuie comandați separat, la cerere.*



# COMBI GLASS

This fresh design is a tribute to modern creativity. The practical shape makes this radiator ideal for any room setting. With its glass design, COMBI GLASS adds elegance and sophistication to any living area.

*Cu un design remarcabil, COMBI GLASS este un tribut adus creativității moderne. Foarte practic și elegant prin designul ingenios al sticlei, COMBI GLASS aduce un plus de stil și rafinament în orice încăpere.*

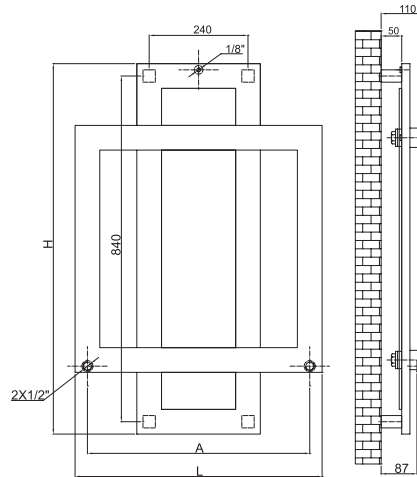

Max. working pressure/  
Presiune max. de lucru 5.5 bar



Max. working temperature/  
Temperatură max. de lucru 90°C



Mounting kit included/  
Kit montaj inclus: K06 page 203



Factory pressure test/  
Presiune de probă: 7 bar



Elements/  
Elemente: 60x20mm

Code/ Cod	Finish / Finisaj	Height/ Înălțime (H)	Length/ Lățime (L)	Centres/ Interax (A)	No el/Nr elemente	Weight/ Greutate	Volume/ Volum	OUTPUT/PUTERE TERMICĂ (watt)		
								Δt=30°C	Δt=50°C	Δt=60°C
		mm	mm	mm	pcs	kg	l	W	W	W
CBG090/060V9010	RAL 9010 white/alb*	900	600	540	2	11,00	3,90	181	345	430
CBG090/060CR	Chrome / Cromat	900	600	540	2	11,00	3,90	139	265	331

We can make custom dimensions, after technical analysis. | Putem executa dimensiuni speciale, în urma unei analize tehnice.

Hydraulic connections/  
Conexiuni hidraulice\*\*



\* For other colours, put your desired RADOX colour code instead of 9010 (standard white). For more details, see page 194  
Pentru alte culori, se pune codul culorii RADOX dorite în locul codului 9010 (standard alb). Mai multe detalii la pag. 194

\*\* When you order, you must mention the type of connection you require. The price changes according to the requirements.  
Când comandați trebuie să menționați tipul de alimentare necesar. Prețul se modifică în funcție de cerințe.



FAN

Valves are not included and must be ordered separately, if required.  
*Robineții nu sunt incluși și trebuie comandați separat, la cerere.*



# FAN

With an unique design, FAN is suitable for modern lifestyle applications and architectural spaces. Choose from our wide selection of RAL colours to match your theme and put the finishing touch to your stylish living. Also our special robehooks will make a practical and fashionable addition to this chic radiator.

O prezență originală, radiatorul FAN este alegerea perfectă pentru un stil de viață modern. Paleta de culori RAL permite amplasarea radiatorului FAN în orice stil arhitectural. De asemenea, accesoriile RADOX (robehooks) vor da o notă de eleganță și utilitate sporită acestui modern radiator.

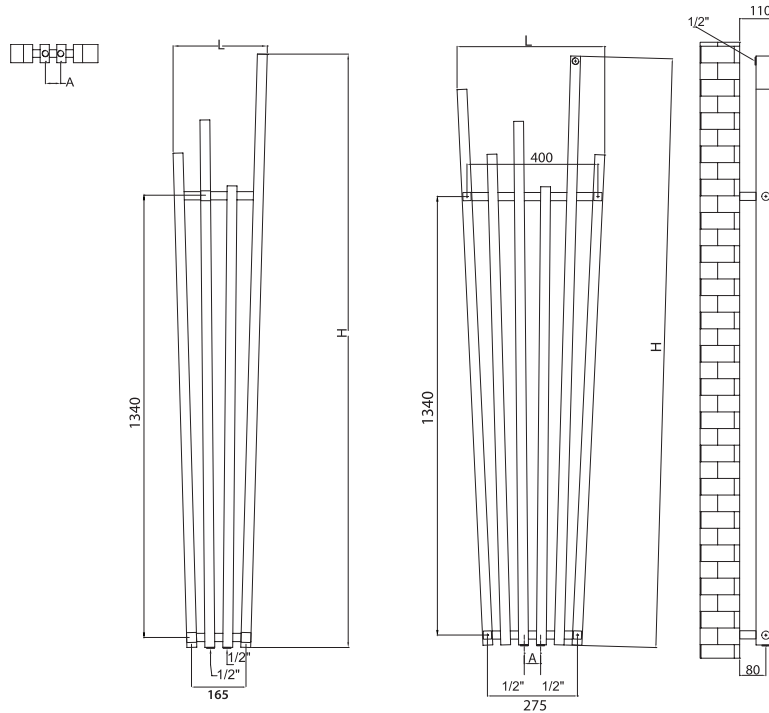
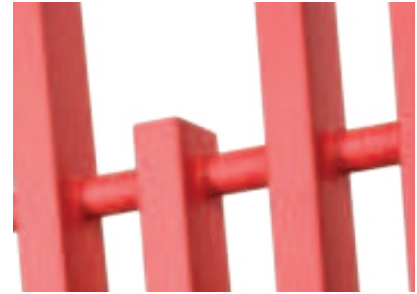

Max. working pressure/  
Presiune max. de lucru  
7 bar



Max. working temperature/  
Temperatură max. de lucru  
90°C



Mounting kit included/  
Kit montaj inclus:  
K24 page 203



Factory pressure test/  
Presiune de probă:  
10 bar



Elements/  
Elemente:  
60x30mm



Collectors/  
Colectori:  
Ø25mm

Code/ Cod	Finish / Finisaj	Height/ Înălțime (H) mm	Length/ Lățime (L) mm	Centres/ Interax (A) mm	No el/Nr elemente pcs	Weight/ Greutate kg	Volume/ Volum l	OUTPUT/PUTERE TERMICĂ (watt)			
								Δt=30°C W	Δt=50°C W	Δt=60°C W	electric W
FAN501800*04V9010	RAL 9010	1800	285	50	4	13,40	9,80	305	582	728	600
FAN501800*06V9010	white/alb*	1800	451	50	6	20,20	14,80	459	876	1095	800
FAN501800*04XX	Inox	1800	285	50	4	13,40	9,80	235	448	560	600
FAN501800*06XX		1800	451	50	6	20,20	14,80	353	674	842	800

● We can make custom dimensions, after technical analysis. | Putem executa dimensiuni speciale, în urma unei analize tehnice. The mentioned code is for hydronic version. | Codul menționat este pentru versiunea hidraulică.

Hydraulic connections/  
Conexiuni hidraulice\*\*



\* For other colours, put your desired RADOX colour code instead of 9010 (standard white). For more details, see page 194  
Pentru alte culori, se pune codul culorii RADOX dorite în locul codului 9010 (standard alb). Mai multe detalii la pag. 194

\*\* When you order, you must mention the type of connection you require. The price changes according to the requirements.  
Când comandați trebuie să menționați tipul de alimentare necesar. Prețul se modifică în funcție de cerințe.



# INVISIBLE 40

Valves are not included and must be ordered separately, if required.  
*Robineții nu sunt incluși și trebuie comandați separat, la cerere.*





# INVISIBLE 40

All in the detail. The slim mirrors and attractive patterns make this radiator so pleasing to the eye. INVISIBLE 40 is an affordable designer elegance at your fingertips, available in a large range of RAL colours and stainless steel.

*Detaliile contează! Oglizile și elementii verticali vor crea un efect spectaculos oriunde va fi amplasat radiatorul INVISIBLE 40. Este un radiator de design accesibil și disponibil în orice culoare din gama RAL și inox.*

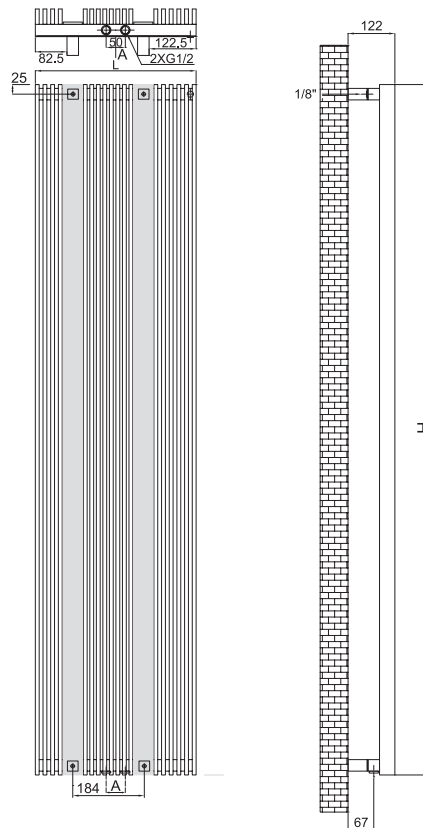

Max. working pressure/  
Presiune max. de lucru  
5 (inox) / 7 (ral) bar



Max. working temperature/  
Temperatură max. de lucru  
90°C



Mounting kit included/  
Kit montaj inclus:  
K06 page 203



Factory pressure test/  
Presiune de probă:  
7 (inox) / 10 (ral) bar



Elements/  
Elemente:  
40x10mm



Collectors/  
Colectori:  
30x30mm

Code/ Cod	Finish / Finisaj	Height/ Înălțime (H)	Length/ Lățime (L)	Centres/ Interax (A)	No el/Nr elemente	Weight/ Greutate	Volume/ Volum	OUTPUT/PUTERE TERMICĂ (watt)		
								Δt=30°C	Δt=50°C	Δt=60°C
		mm	mm	mm	pcs	kg	l	W	W	W
INV401500*18V9010	RAL 9010	1500	419	50	18	31,00	7,60	736	1404	1685
INV401800*18V9010	white/alb*	1800	419	50	18	37,00	9,00	877	1674	2009
INV401500*18XL	Stainless	1500	419	50	18	31,00	7,60	545	1040	1248
INV401800*18XL	steel /INOX	1800	419	50	18	37,00	9,00	650	1240	1488

We can make custom dimensions, after technical analysis. | Putem executa dimensiuni speciale, în urma unei analize tehnice.

Hydraulic connections/  
Conexiuni hidraulice\*\*



\* For other colours, put your desired RADOX colour code instead of 9010 (standard white). For more details, see page 194  
Pentru alte culori, se pune codul culorii RADOX dorite în locul codului 9010 (standard alb). Mai multe detalii la pag. 194

\*\* When you order, you must mention the type of connection you require. The price changes according to the requirements.  
Când comandați trebuie să menționați tipul de alimentare necesar. Prețul se modifică în funcție de cerințe.



# INVISIBLE 40 WOOD

Valves are not included and must be ordered separately, if required.  
*Robineții nu sunt incluși și trebuie comandați separat, la cerere.*



# INVISIBLE 40 WOOD

INVISIBLE 40 WOOD is the latest organically finished RADOX radiator. With great outputs, it is available in 3 wood finishes - Oak, Walnut and Fir. As INVISIBLE 40 WOOD is finished using natural materials, every beautiful INVISIBLE 40 WOOD is unique in tone and pattern.

INVISIBLE 40 WOOD este cel mai nou radiator RADOX din punct de vedere al materialelor naturale folosite. Cu un randament termic foarte bun, este disponibil cu 3 tipuri de lemn - stejar, nuc și brad. Fiind finisat cu materiale naturale, fiecare INVISIBLE 40 WOOD este unic în nuanțe și model.

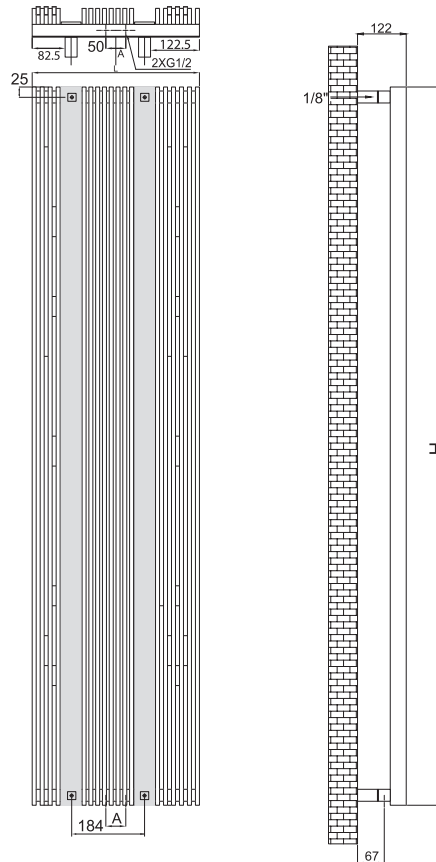

Max. working pressure/  
Presiune max. de lucru  
7 bar



Max. working temperature/  
Temperatură max. de lucru  
90°C



Mounting kit included/  
Kit montaj inclus:  
K06 page 203



Factory pressure test/  
Presiune de probă:  
10 bar



Elements/  
Elemente:  
40x10mm



Collectors/  
Colectori:  
30x30mm

Code/ Cod	Finish / Finisaj	Height/ Înălțime (H) mm	Length/ Lățime (L) mm	Centres/ Interax (A) mm	No el/Nr elemente pcs	Weight/ Greutate kg	Volume/ Volum l	OUTPUT/PUTERE TERMICĂ (watt)		
								Δt=30°C W	Δt=50°C W	Δt=60°C W
INV401500*18V9010	RAL 9010	1500	419	50	18	31,00	7,60	736	1404	1685
INV401800*18V9010	white/alb*	1800	419	50	18	37,00	9,00	877	1674	2009

☛ We can make custom dimensions, after technical analysis. | Putem executa dimensiuni speciale, în urma unei analize tehnice.

Hydraulic connections/  
Conexiuni hidraulice\*\*



\* For other colours, put your desired RADOX colour code instead of 9010 (standard white). For more details, see page 194  
Pentru alte culori, se pune codul culorii RADOX dorite în locul codului 9010 (standard alb). Mai multe detalii la pag. 194

\*\* When you order, you must mention the type of connection you require. The price changes according to the requirements.  
Când comandați trebuie să menționați tipul de alimentare necesar. Prețul se modifică în funcție de cerințe.



# KING

Valves are not included and must be ordered separately, if required.  
*Robineții nu sunt incluși și trebuie comandați separat, la cerere.*

# KING

Wall mounted, KING is a discreet convector with a compact design with high heat output. Available in multiple sizes and colours options, KING is an ideal convector for any domestic or commercial applications.

*KING este un convector discret, însă extrem de eficient, cu un randament termic foarte bun. Disponibil în mai multe dimensiuni și culori, KING este un convector ideal atât pentru spații rezidențiale, cât și comerciale.*

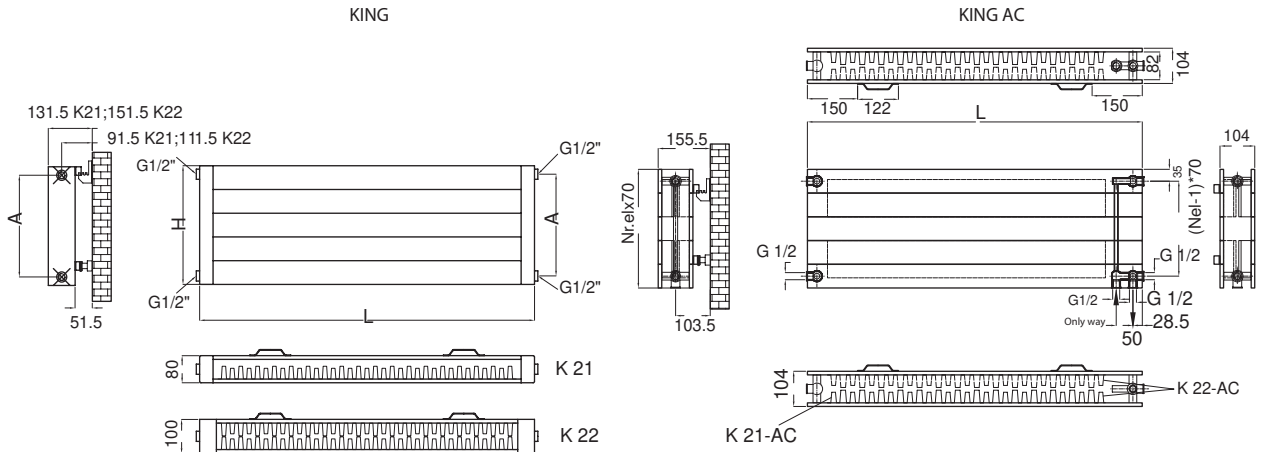

-   
 Max. working pressure/  
*Presiune max. de lucru 5.5 bar*
-   
 Max. working temperature/  
*Temperatură max. de lucru 90°C*
-   
 Mounting kit included/  
*Kit montaj inclus: K08 page 203*
-   
 Factory pressure test/  
*Presiune de probă: 7 bar*
-   
 Elements/Elemente:  
*70x11mm*

Code/ Cod	Finish / Finisaj	Height/ Înălțime (H)	Length/ Lățime (L)	Centres/ Interax (A)	Weight/ Greutate	Volume/ Volum	OUTPUT/PUTERE TERMICĂ (watt)			
							Δt=30°C	Δt=50°C	Δt=60°C	
		mm	mm	mm	kg	l	W	W	W	
21	RAL 9010 white/alb*	PK21/280/1000V9010	280	1000	230	19,00	5,50	513	980	1225
		PK21/280/1500V9010	280	1500	230	28,10	7,60	773	1475	1844
		PK21/350/1000V9010	350	1000	300	23,70	6,80	642	1225	1531
		PK21/350/1500V9010	350	1500	300	35,10	9,50	967	1846	2307
		PK21/420/1000V9010	420	1000	370	28,50	8,20	771	1471	1838
		PK21/420/1500V9010	420	1500	370	42,20	11,40	1161	2217	2771
		PK21/630/1000V9010	630	1000	580	46,10	13,10	1251	2386	2983
22	RAL 9010 white/alb*	PK21/630/1500V9010	630	1500	580	66,70	17,90	1838	3508	4385
		PK22/280/1000V9010	280	1000	230	20,80	6,30	618	1179	1473
		PK22/280/1500V9010	280	1500	230	30,80	8,50	935	1785	2231
		PK22/350/1000V9010	350	1000	300	26,00	7,90	772	1473	1841
		PK22/350/1500V9010	350	1500	300	38,60	10,60	1169	2232	2790
		PK22/420/1000V9010	420	1000	370	31,30	9,50	926	1767	2209
		PK22/420/1500V9010	420	1500	370	46,30	12,70	1404	2679	3348
PK22/630/1000V9010	630	1000	580	51,50	15,20	1532	2924	3655		
PK22/630/1500V9010	630	1500	580	74,20	20,00	2250	4293	5367		

● We can make custom dimensions, after technical analysis. | *Putem executa dimensiuni speciale, în urma unei analize tehnice.*  
 Minimum height for KING AC is 140mm. | *Înălțimea minimă pentru KING AC este 140mm.*

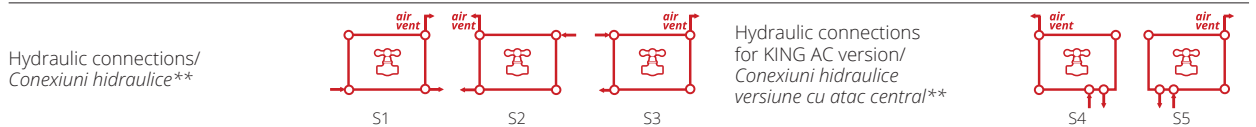

\* For other colours, put your desired RADOX colour code instead of 9010 (standard white). For more details, see page 194  
 Pentru alte culori, se pune codul culorii RADOX dorite în locul codului 9010 (standard alb). Mai multe detalii la pag. 194  
 \*\* When you order, you must mention the type of connection you require. The price changes according to the requirements.  
 Când comandați trebuie să menționați tipul de alimentare necesar. Prețul se modifică în funcție de cerințe.



# KOLONA SP35

Valves are not included and must be ordered separately, if required.  
*Robineții nu sunt incluși și trebuie comandați separat, la cerere.*





LYA

Valves are not included and must be ordered separately, if required.  
*Robineții nu sunt incluși și trebuie comandați separat, la cerere.*





# LYA

DESIGNER RADIATORS / RADIATOARE DE DESIGN

LYA is a modern vertical designer radiator, designed to warm up and add style to any space. Its rectangular shaped tubes will look like an artistic piece on any wall, while the colour will correspond with the rest of the interior. A contemporary radiator, LYA is the perfect heating solution for any room.

LYA este un radiator decorativ, modern, conceput pentru a încălzi și a adăuga stil oricărei încăperi. Succesiunea elementelor dreptunghiulare îi conferă o notă artistică, în timp ce culoarea va completa cu succes interiorul camerei. Un radiator contemporan, unic și eficient, LYA este soluția ideală de încălzire a oricărei camere.

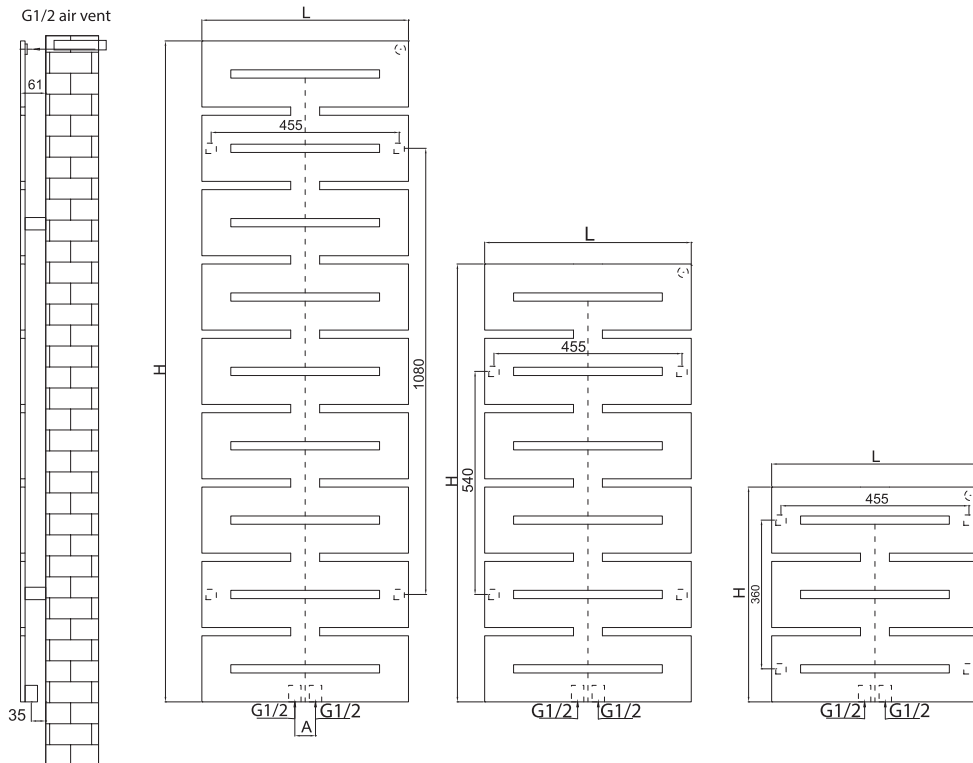
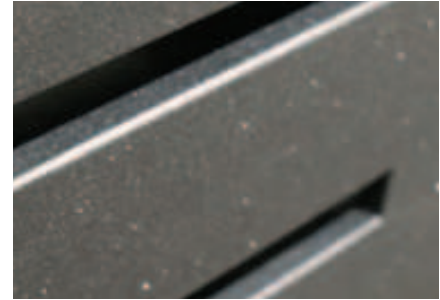

Max. working pressure/  
Presiune max. de lucru 4 bar



Max. working temperature/  
Temperatură max. de lucru 90°C



Mounting kit included/  
Kit montaj inclus: K06 page 203



Factory pressure test/  
Presiune de probă: 5.2 bar



Elements&collectors/  
Elemente&colectori: 70x11mm

Code/ Cod	Finish / Finisaj	Height/ Înălțime (H)	Length/ Lățime (L)	Centres/ Interax (A)	No el/Nr elemente	Weight/ Greutate	Volume/ Volum	OUTPUT/PUTERE TERMICĂ (watt)		
								Δt=30°C	Δt=50°C	Δt=60°C
		mm	mm	mm	pcs	kg	l	W	W	W
LYA050/052V9010	RAL 9010	520	500	50	3	5,80	1,70	133	256	320
LYA050/106V9010	white/alb*	1060	500	50	6	11,60	3,40	267	514	642
LYA050/160V9010		1600	500	50	9	17,50	5,10	401	771	964

● We can make custom dimensions, after technical analysis. | Putem executa dimensiuni speciale, în urma unei analize tehnice.

Hydraulic connections/  
Conexiuni hidraulice\*\*



\* For other colours, put your desired RADOX colour code instead of 9010 (standard white). For more details, see page 194  
Pentru alte culori, se pune codul culorii RADOX dorite în locul codului 9010 (standard alb). Mai multe detalii la pag. 194

\*\* When you order, you must mention the type of connection you require. The price changes according to the requirements.  
Când comandați trebuie să menționați tipul de alimentare necesar. Prețul se modifică în funcție de cerințe.



# MAZE

Valves are not included and must be ordered separately, if required.  
*Robineții nu sunt incluși și trebuie comandați separat, la cerere.*

# MAZE

A contemporary slender radiator which delivers elegance to any home. MAZE's distinctive labyrinth design adds flavor to a room while typical modern radiators essentially draw from it.

*Un radiator cu un design contemporan ideal pentru orice casă. Cu un design rectangular, MAZE nu este nici pe departe un banal corp de încălzire.*

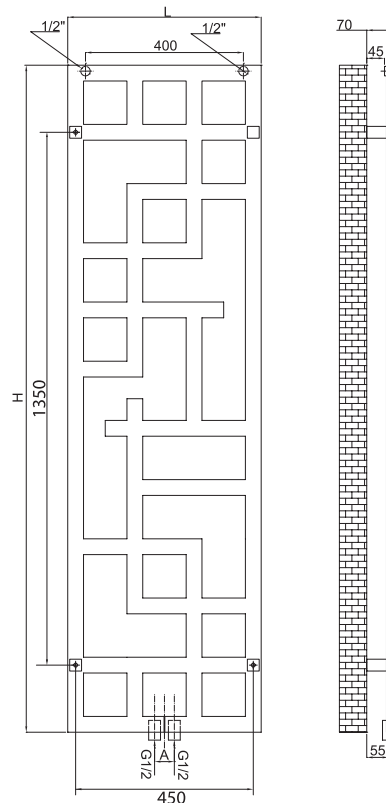

Max. working pressure/  
Presiune max. de lucru 7 bar



Max. working temperature/  
Temperatură max. de lucru 90°C



Mounting kit included/  
Kit montaj inclus: K06 page 203



Factory pressure test/  
Presiune de probă: 13 bar



Elements & collectors/  
Elemente și colectori: 40x20mm

Code/ Cod	Finish / Finisaj	Height/ Înălțime (H)	Length/ Lățime (L)	Centres/ Interax (A)	Weight/ Greutate	Volume/ Volum	OUTPUT/PUTERE TERMICĂ (watt)		
							Δt=30°C	Δt=50°C	Δt=60°C
		mm	mm	mm	kg	l	W	W	W
MAZP049/169RAL9010	RAL 9010 white/alb*	1690	490	50	12,40	5,80	296	564	705
MAZEP049/169CR	Chrome / Cromat	1690	490	50	12,40	5,80	227	434	542
MAZEP049/169XL	Stainless steel /INOX	1690	490	50	12,40	5,80	219	418	522

● We can make custom dimensions, after technical analysis. | Putem executa dimensiuni speciale, în urma unei analize tehnice.

Hydraulic connections/  
Conexiuni hidraulice\*\*



\* For other colours, put your desired RADOX colour code instead of 9010 (standard white). For more details, see page 194  
Pentru alte culori, se pune codul culorii RADOX dorite în locul codului 9010 (standard alb). Mai multe detalii la pag. 194

\*\* When you order, you must mention the type of connection you require. The price changes according to the requirements.  
Când comandați trebuie să menționați tipul de alimentare necesar. Prețul se modifică în funcție de cerințe.



# MEGA

Valves are not included and must be ordered separately, if required.  
*Robineții nu sunt incluși și trebuie comandați separat, la cerere.*



# MEGA

Utilizing unique welding technology, MEGA is a modern reinterpretation of a vertical radiator. Determinate and powerful, its single (mono) or double configuration (bi) of elements create a relentless pace accentuating the dynamic radiator, with its unique empty centered elements. As well as bringing that special touch to your space, MEGA has a high heat output with low water volume.

MEGA reprezintă o inovație a radiatorului vertical, incomparabil datorită tehnologiei unice de sudare folosită în realizarea lui. Configurația simplă (mono) sau dublă (bi) de elemente tubulari care au zona centrală goală, creează un ritm dinamic care se armonizează perfect cu stilul de viață modern. MEGA este un radiator robust și elegant, eficient energetic datorită volumului foarte mic de apă necesar.



Mega mono

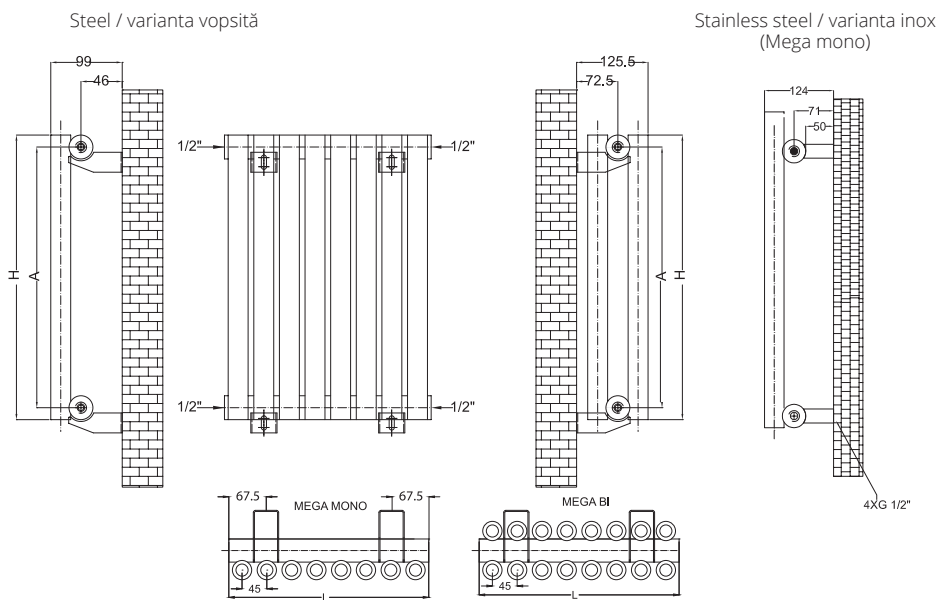

Max. working pressure/  
Presiune max. de lucru  
10 bar



Max. working temperature/  
Temperatură max. de lucru  
90°C



Mounting kit included/  
Kit montaj inclus:  
K12/15 page 203



Factory pressure test/  
Presiune de probă:  
13 bar



Elements/  
Elemente:  
Ø35mm



Collectors/  
Colectori:  
Ø42mm

	Code/ Cod	Finish / Finisaj	Height/ Înălțime (H)	Length/ Lățime (L)	Centres/ Interax (A)	No el/Nr elemente	Weight/ Greutate	Volume/ Volum	OUTPUT/PUTERE TERMICĂ (watt)		
									Δt=30°C	Δt=50°C	Δt=60°C
			mm	mm	mm	pcs	kg	l	W	W	W
mono	MM1500*08V9010E	RAL 9010	1500	363	1458	8	31,80	13,10	373	712	890
	MM1800*08V9010E	white/alb*	1800	363	1758	8	37,70	15,50	442	844	1055
	MM1500*08XL	Stainless	1500	363	1458	8	31,80	13,10	277	528	660
	MM1800*08XL	steel /INOX	1800	363	1758	8	37,70	15,50	328	625	782
bi	MB1500*08V9010E	RAL 9010	1500	363	1458	16	61,80	25,10	721	1377	1721
	MB1800*08V9010	white/alb*	1800	363	1758	16	73,60	30,00	860	1641	2051

● We can make custom dimensions, after technical analysis. | Putem executa dimensiuni speciale, în urma unei analize tehnice.

Hydraulic connections/  
Conexiuni hidraulice\*\*



S1



S2

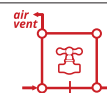

S3



S4

\* For other colours, put your desired RADOX colour code instead of 9010 (standard white). For more details, see page 194  
Pentru alte culori, se pune codul culorii RADOX dorite în locul codului 9010 (standard alb). Mai multe detalii la pag. 194

\*\* When you order, you must mention the type of connection you require. The price changes according to the requirements.  
Când comandați trebuie să menționați tipul de alimentare necesar. Prețul se modifică în funcție de cerințe.



# MEGA BURLANI

Valves are not included and must be ordered separately, if required.  
*Robineții nu sunt incluși și trebuie comandați separat, la cerere.*



# MEGA BURLANI

Tube within tube design, MEGA BURLANI offers superb heat delivery, easy to fit in any modern room. Stylish design with energy efficient technology, MEGA BURLANI is available in a variety of colours, both horizontal and vertical versions.

MEGA BURLANI are un design unic, sistem „țeavă în țeavă” oferind confort termic și, în același timp, fiind ușor de amplasat în orice încăpere. Design elegant și tehnologie inteligentă, MEGA BURLANI este disponibil într-o varietate de culori, versiunea verticală și orizontală.

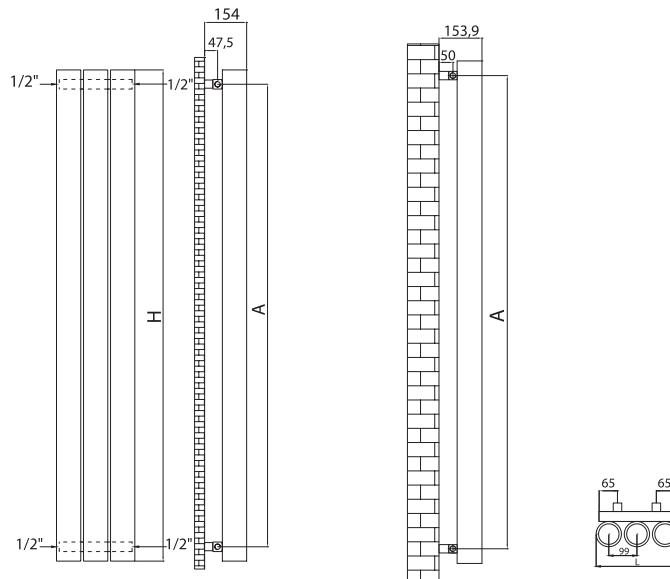
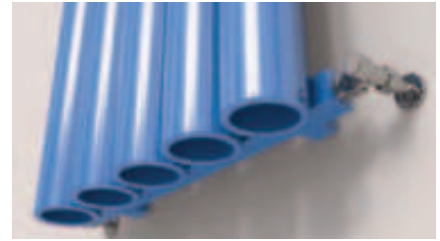

Max. working pressure/  
Presiune max. de lucru  
10 bar



Max. working temperature/  
Temperatură max. de lucru  
90°C



Mounting kit included/  
Kit montaj inclus:  
K06 page 203



Factory pressure test/  
Presiune de probă:  
13 bar



Elements/  
Elemente:  
Ø89mm



Collectors/  
Colectori:  
35x35 mm

Code/ Cod	Finish / Finisaj	Height/ Înălțime (H)	Length/ Lățime (L)	Centres/ Interax (A)	No el/Nr elemente	Weight/ Greutate	Volume/ Volum	OUTPUT/PUTERE TERMICĂ (watt)		
								Δt=30°C	Δt=50°C	Δt=60°C
		mm	mm	mm	pcs	kg	l	W	W	W
MBR800*01V9010	RAL 9010 white/alb*	800	89	695	1	6,40	1,40	112	214	267
MBR800*03V9010		800	287	695	3	19,40	4,30	340	649	812
MBR800*04V9010		800	386	695	4	25,90	5,80	454	867	1084
MBR800*05V9010		800	485	695	5	32,40	7,20	568	1085	1356
MBR1800*01V9010		1800	89	1695	1	14,20	3,00	244	467	583
MBR1800*03V9010		1800	287	1695	3	42,60	9,10	738	1408	1760
MBR1800*04V9010		1800	386	1695	4	56,90	12,10	984	1879	2348
MBR1800*05V9010		1800	485	1695	5	71,10	15,10	1231	2349	2937

● We can make custom dimensions, after technical analysis. | Putem executa dimensiuni speciale, în urma unei analize tehnice.

Hydraulic connections/  
Conexiuni hidraulice\*\*



\* For other colours, put your desired RADOX colour code instead of 9010 (standard white). For more details, see page 194  
Pentru alte culori, se pune codul culorii RADOX dorite în locul codului 9010 (standard alb). Mai multe detalii la pag. 194

\*\* When you order, you must mention the type of connection you require. The price changes according to the requirements.  
Când comandați trebuie să menționați tipul de alimentare necesar. Prețul se modifică în funcție de cerințe.



# MULTICOLONA SQUARE

Valves are not included and must be ordered separately, if required.  
*Robineții nu sunt incluși și trebuie comandați separat, la cerere.*



# MULTICOLONA SQUARE

MULTICOLONA SQUARE is a classic steel column radiator, ideal for most applications. Its modular design allows it to be easily personalized in a wide range of sizes and finishes, very versatile in both modern and period settings. When sometimes all you need is a radiator with a simple look and great heat outputs, MULTICOLONA SQUARE is just what you are looking for.

MULTICOLONA SQUARE este un radiator ideal pentru orice încăpere. Designul modular permite personalizarea, având la dispoziție o gamă largă de dimensiuni și finisaje. Este un model versatil care va completa cu succes un stil arhitectural modern, minimalist, dar și un ambient rafinat și pretentios. Atunci când aveți nevoie de un radiator cu un design simplu, dar atractiv și cu putere termică mare, MULTICOLONA SQUARE este alegerea potrivită!

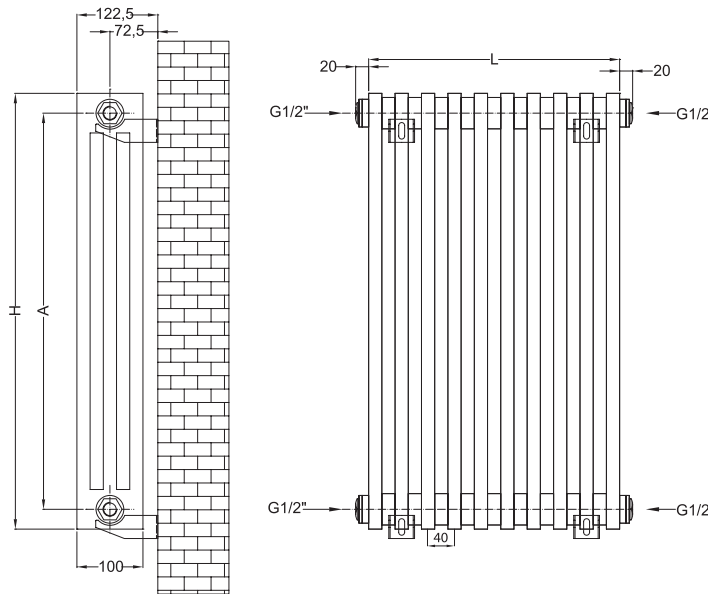

Max. working pressure/  
Presiune max. de lucru 7 bar



Max. working temperature/  
Temperatură max. de lucru 90°C



Mounting kit included/  
Kit montaj inclus: K15 page 203



Factory pressure test/  
Presiune de probă: 10 bar



Elements/Elemenți:  
20x20mm

Code/ Cod	Finish/ Finisaj	Height/ Înălțime (H)	Length/ Lățime (L)	Centres/ Interax (A)	No el/Nr elementi	Weight/ Greutate	Volume/ Volum	OUTPUT/PUTERE TERMICĂ (watt)		
								Δt=30°C	Δt=50°C	Δt=60°C
		mm	mm	mm	pcs	kg	l	W	W	W
MULTICOLONA SQUARE	RAL 9010 white/alb*	660	400	600	10	20.80	7.00	472	901	1,126
MULTICOLONA SQUARE		660	600	600	15	31.10	10.50	708	1,351	1,689
MULTICOLONA SQUARE		660	800	600	20	41.50	14.00	944	1,802	2,252
MULTICOLONA SQUARE	Chrome / Cromat	660	400	600	10	20.80	7.00	363	693	866
MULTICOLONA SQUARE		660	600	600	15	31.10	10.50	545	1,039	1,299
MULTICOLONA SQUARE		660	800	600	20	41.50	14.00	726	1,386	1,732
MULTICOLONA SQUARE	Stainless steel /INOX	660	400	600	10	20.80	7.00	350	667	834
MULTICOLONA SQUARE		660	600	600	15	31.10	10.50	524	1,001	1,251
MULTICOLONA SQUARE		660	800	600	20	41.50	14.00	699	1,335	1,668

● We can make custom dimensions, after technical analysis. | Putem executa dimensiuni speciale, în urma unei analize tehnice.

Hydraulic connections/  
Conexiuni hidraulice\*\*



S1



S2



S3



S4

\* For other colours, put your desired RADOX colour code instead of 9010 (standard white). For more details, see page 194  
Pentru alte culori, se pune codul culorii RADOX dorite în locul codului 9010 (standard alb). Mai multe detalii la pag. 194

\*\* When you order, you must mention the type of connection you require. The price changes according to the requirements.  
Când comandați trebuie să menționați tipul de alimentare necesar. Prețul se modifică în funcție de cerințe.



# NOVA

Valves are not included and must be ordered separately, if required.  
*Robineții nu sunt incluși și trebuie comandați separat, la cerere.*



# NOVA

This tall, versatile radiator, with its slim panels, however good outputs, is an interior designers dream. Very easy to install, NOVA is a vertical radiator but also available as an horizontal radiator. Also it can be accessorized with one or more towel bars, placed where the client wishes.

Acest radiator înalt, cu o bună putere termică, este visul oricărui designer de interior. NOVA este foarte ușor de instalat, disponibil în variantă verticală și orizontală. De asemenea, poate fi accessorizat cu unul sau mai multe suporturi pentru prosoape.

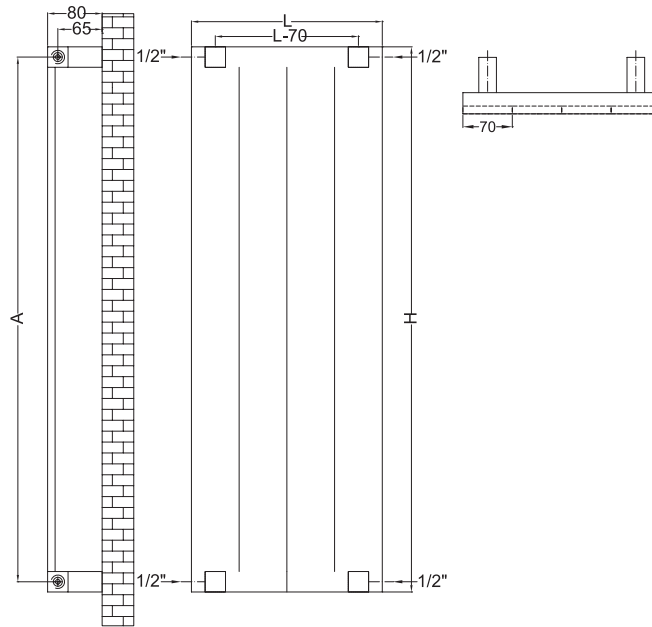

Max. working pressure/  
Presiune max. de lucru 5.5 bar



Max. working temperature/  
Temperatură max. de lucru 90°C



Mounting kit included/  
Kit montaj inclus: K06 page 203



Factory pressure test/  
Presiune de probă: 7 bar



Elements/Elemente:  
70x11mm

Code/ Cod	Finish / Finisaj	Height/ Înălțime (H)	Length/ Lățime (L)	Centres/ Interax (A)	No el/Nr elemente	Weight/ Greutate	Volume/ Volum	OUTPUT/PUTERE TERMICĂ (watt)			
								Δt=30°C	Δt=50°C	Δt=60°C	electric***
		mm	mm	mm	pcs	kg	l	W	W	W	W
NO1200*04V9010	RAL 9010 white/ alb*	1200	280	1170	4	9,50	2,90	185	353	423	300
NO1200*06V9010		1200	420	1170	6	14,20	4,30	274	522	627	600
NO1200*09V9010		1200	630	1170	9	21,30	6,40	407	777	932	800
NO1500*04V9010		1500	280	1470	4	11,70	3,50	231	440	528	500
NO1500*06V9010		1500	420	1470	6	17,60	5,20	341	652	782	600
NO1500*09V9010		1500	630	1470	9	26,30	7,90	508	969	1163	1200
NO1800*04V9010		1800	280	1770	4	14,00	4,10	276	527	633	600
NO1800*06V9010		1800	420	1770	6	20,90	6,20	409	781	937	800
NO1800*09V9010		1800	630	1770	9	31,30	9,30	608	1161	1394	1200

● We can make custom dimensions, after technical analysis. | Putem executa dimensiuni speciale, în urma unei analize tehnice.  
The mentioned code is for hydronic version. | Codul menționat este pentru versiunea hidraulică.

Hydraulic connections  
for vertical version/  
Conexiuni hidraulice  
versiune verticală\*\*

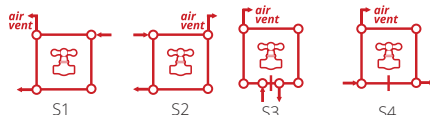

Hydraulic connections  
for horizontal version/  
Conexiuni hidraulice  
versiune orizontală\*\*

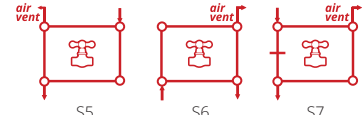

\* For other colours, put your desired RADOX colour code instead of 9010 (standard white). For more details, see page 194  
Pentru alte culori, se pune codul culorii RADOX dorite în locul codului 9010 (standard alb). Mai multe detalii la pag. 194

\*\* When you order, you must mention the type of connection you require. The price changes according to the requirements.  
Când comandați trebuie să menționați tipul de alimentare necesar. Prețul se modifică în funcție de cerințe.

\*\*\* NOVA PMIX2 is the electric version of NOVA. Please order accordingly.  
NOVA PMIX2 este modelul electric al radiatorului NOVA și trebuie comandat cu aceasta denumire



# NOVA GLASS/MIRROR

Valves are not included and must be ordered separately, if required.  
*Robineții nu sunt incluși și trebuie comandați separat, la cerere.*

# NOVA GLASS / MIRROR

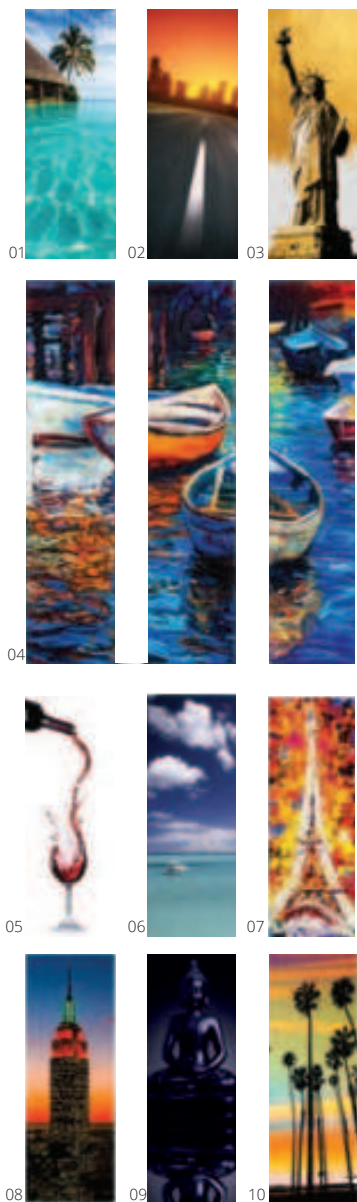

An exquisite radiant design, NOVA GLASS/MIRROR's tubes are concealed behind a work of art (of your choosing) painted on a panel of glass. A mirror can be affixed in lieu of artwork. It is available horizontally or vertically, in any colour with three mirrored finishes (clear, grey and bronze) and is fitted with a 6mm safety glass backing. Also, it can be accessorized with one or more towel bars placed where the client wishes.

NOVA GLASS/MIRROR este un radiator splendid, elementii sunt inteligent ascunși în spatele unui panou personalizat cu o imagine spectaculoasă, de orice culoare, cu orice imagine sau chiar cu o oglindă clară, gri sau bronz. Orice interior poate fi completat cu un radiator original NOVA GLASS/MIRROR, eficient și puternic, disponibil în variantă orizontală sau verticală și chiar electric. Toate radiatoarele au sticlă securizată de 6 mm și sunt ideale pentru orice cameră. De asemenea, poate fi accessorizat cu unul sau mai multe suporturi pentru prosoape.

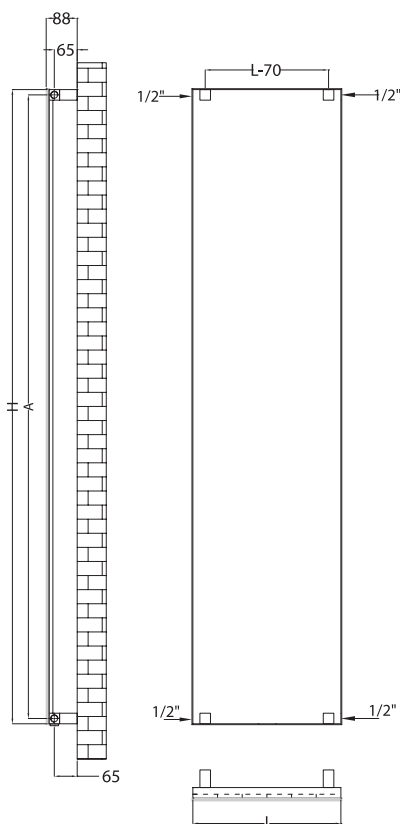

Max. working pressure/  
Presiune max. de lucru 5.5 bar



Max. working temperature/  
Temperatură max. de lucru 90°C



Mounting kit included/  
Kit montaj inclus: K06 page 203



Factory pressure test/  
Presiune de probă: 7 bar



Elements/Elementi:  
70x11mm

For more images, see next pages. Găsiți mai multe imagini, în paginile următoare.

Code/ Cod	Finish / Finisaj	Height/ Înălțime (H)	Length/ Lățime (L)	Centres/ Interax (A)	No el/Nr elementi	Weight/ Greutate	Volume/ Volum	OUTPUT/PUTERE TERMICĂ (watt)				
								Δt=30°C	Δt=50°C	Δt=60°C	electric***	
		mm	mm	mm	pcs	kg	l	W	W	W	W	
NOVA GLASS	NO1200*06V9010ST	RAL 9010 white/ alb*	1200	420	1170	6	19,20	4,30	274	522	627	600
	NO1500*06V9010ST		1500	420	1470	6	23,90	5,20	341	652	782	600
	NO1800*06V9010ST		1800	420	1770	6	28,50	6,20	409	781	937	800
NOVA MIRROR	NO1200*06V9010GLMI	RAL 9010 white/ alb*	1200	420	1170	6	19,20	4,30	274	522	627	600
	NO1500*06V9010GLMI		1500	420	1470	6	23,90	5,20	341	652	782	600
	NO1800*06V9010GLMI		1800	420	1770	6	28,50	6,20	409	781	937	800

● We can make custom dimensions, after technical analysis. | Putem executa dimensiuni speciale, în urma unei analize tehnice.  
The mentioned code is for hydronic version. | Codul menționat este pentru versiunea hidraulică.

Hydraulic connections  
for vertical version/  
Conexiuni hidraulice  
versiune verticală\*\*

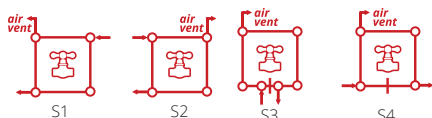

Hydraulic connections  
for horizontal version/  
Conexiuni hidraulice  
versiune orizontală\*\*

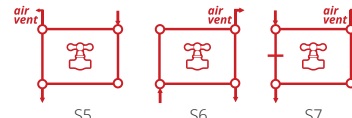

\* For other colours, put your desired RADOX colour code instead of 9010 (standard white). For more details, see page 194  
Pentru alte culori, se pune codul culorii RADOX dorite în locul codului 9010 (standard alb). Mai multe detalii la pag. 194

\*\* When you order, you must mention the type of connection you require. The price changes according to the requirements.  
Când comandați trebuie să menționați tipul de alimentare necesar. Prețul se modifică în funcție de cerințe.

\*\*\* NOVA PMIX2 GLASS and NOVA PMIX2 MIRROR are the electric version of NOVA with glass and mirror. Please order accordingly.  
NOVA PMIX2 GLASS și NOVA PMIX2 MIRROR sunt modelele electrice ale radiatorului NOVA cu imagine și cu oglindă și trebuie comandate cu aceste denumiri.

## Image glass radiators | Radiatoare cu sticlă

Our image glass radiators spread heat through beautiful images, becoming the canvas of a painter or the support of your life impressions. Our RADOX glass or mirror radiator becomes a design object that personalizes your room, a perfect and unique item. You can choose from our large image gallery—free of charge, or you can bring your favorite images, which will capture forever on the radiator your desired image. For more image ideas, you can take a look at [www.shutterstock.com](http://www.shutterstock.com). There are more than 350 million images available for sale. The chosen image must be in digital format (jpg, tif, eps), minimum resolution 300 dpi, 15MB+ in size and depending on the height and width of the radiator a minimum 2500px is required on the small side. Photos taken on most smartphones are not good enough quality. When choosing an image please remember the shape of the radiator. Images will be cropped to fit. In all cases, the client will receive visual proof of the application on the radiator, and only after approval, the order is confirmed.

As image provider, the customer is responsible for complying with applicable copyright, privacy etc. regulations.

*Radiatoarele RADOX personalizate cu sticlă NOVA GLASS și COMBI GLASS, răspândesc căldura prin intermediul unor imagini spectaculoase sau fotografii ale unor momente dragi din viața voastră. Radiatorul nostru cu sticlă este un produs funcțional, cu un randament termic foarte bun, însă și un element unic de design care vă va personaliza camera. Aveți posibilitatea să alegeți din galeria noastră mare de imagini – în mod gratuit, sau ne puteți trimite imaginile preferate, care vor însuflă pentru totdeauna radiatorul cu imaginea dorită. Pentru mai multe idei de imagine, puteți să aruncați o privire pe [www.shutterstock.com](http://www.shutterstock.com), unde există mai mult de 350 de milioane de imagini disponibile de vânzare. Imaginea selectată trebuie să fie în format digital (jpg, tif, eps), rezoluție minimă 300 dpi, dimensiune de 15 MB + și, în funcție de înălțimea și lățimea radiatorului, minim 2500 pixeli sunt necesari pentru partea mai îngustă a radiatorului. Fotografiile realizate cu majoritatea telefoanelor smart nu au calitatea necesară acestei proceduri. Atunci când alegeți o imagine, rețineți forma radiatorului. Imaginile vor fi tăiate pentru a se potrivi. În toate situațiile, clientul va primi o dovadă vizuală a imaginii așa cum va fi pusă pe radiator și numai după aprobare, comanda va fi confirmată.*

*Ca furnizor de imagini, clientul este responsabil pentru respectarea reglementărilor aplicabile privind drepturile de autor, confidențialitate etc.*

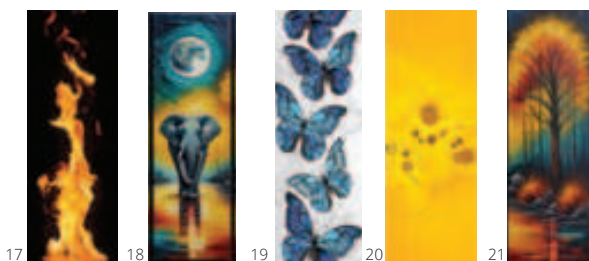
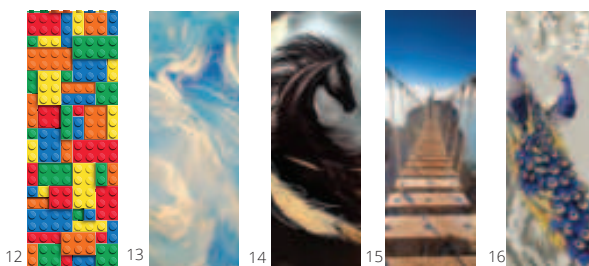
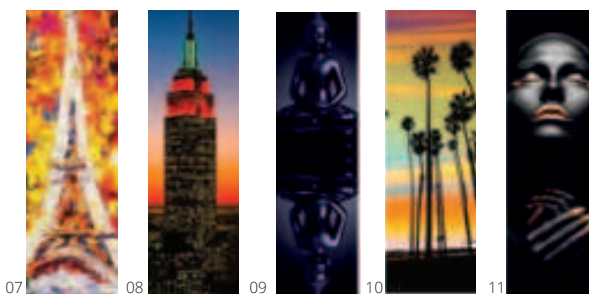
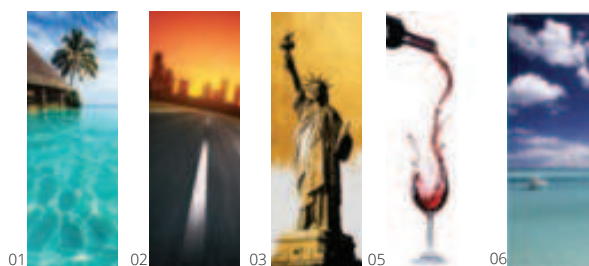

NOVA MIRROR Available vertically or horizontally, NOVA MIRROR can also have three mirrored finishes (clear, grey and bronze)  
 NOVA MIRROR cu oglindă Disponibil în variantă verticală sau orizontală, NOVA MIRROR poate avea și 3 finisoaje de oglindă : clară, gri sau bronz.



Clear mirror / Oglindă clară



Grey mirror / Oglindă gri



Bronze mirror / Oglindă bronz



Image gallery for NOVA GLASS, horizontal version.  
 Galerie de imagini pentru NOVA GLASS, versiune orizontală.

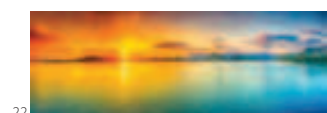



# NOVA PP 45

Valves are not included and must be ordered separately, if required.  
*Robineții nu sunt incluși și trebuie comandați separat, la cerere.*





# NOVA PP 45

With a unique, individual appeal, very smooth due to the steel panel, Nova PP 45 is suitable for modern lifestyle applications and architectural spaces. Its large panel area provides excellent heat outputs, ideal for modern living rooms or offices. Finish your home with a true original Nova PP 45 finished in any RAL colours and available as vertical radiator. Also, it can be accessorized with one or more towel bars placed where the client wishes.

*Nova PP 45 este un model cu un farmec aparte, designul unic, cu panourile de oțel netede fiind în ton cu stilul de viață modern. Panourile generoase oferă confort termic excelent, fiind o piesă de design ideală pentru birou sau un living modern. Este disponibil în orice culoare RAL, variantă verticală. De asemenea, poate fi accesoriizat cu unul sau mai multe suporturi pentru prosoape.*

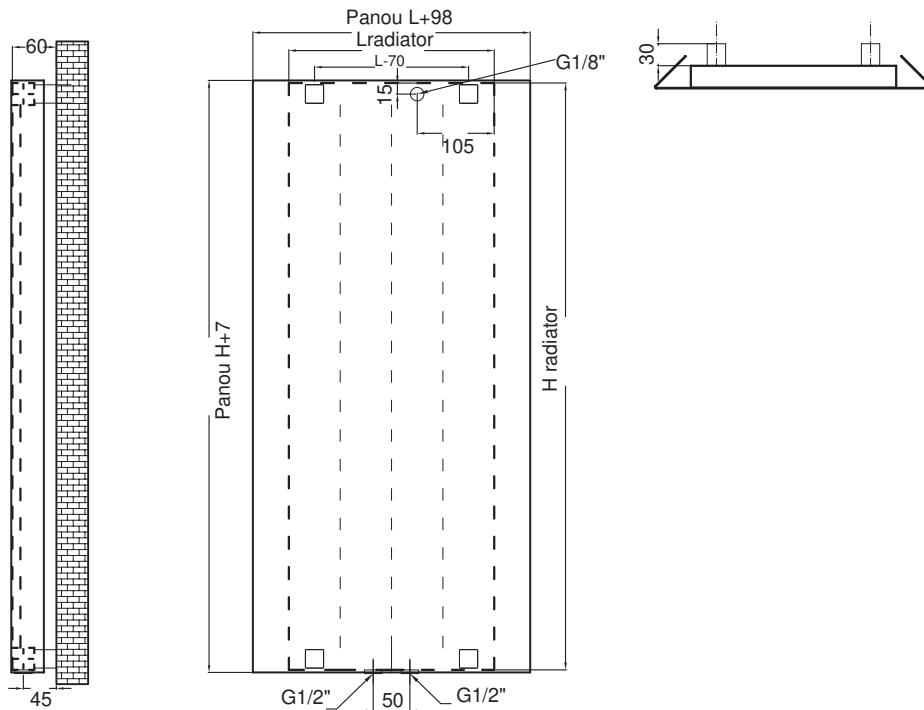

Max. working pressure/  
Presiune max. de lucru 5.5 bar



Max. working temperature/  
Temperatură max. de lucru 90°C



Mounting kit included/  
Kit montaj inclus: K06 page 203



Factory pressure test/  
Presiune de probă: 7 bar



Elements/Elemente:  
70x11mm

Code/ Cod	Finish / Finisaj	Height/ Înălțime (H)	Length/ Lățime (L)	Centres/ Interax (A)	No el/Nr elemente	Weight/ Greutate	Volume/ Volum	OUTPUT/PUTERE TERMICĂ (watt)			
								Δt=30°C	Δt=50°C	Δt=60°C	electric***
		mm	mm	mm	pcs	kg	l	W	W	W	W
NOPP451200*04V9010	RAL 9010 white/ alb*	1207	378	50	4	13,10	2,90	185	353	423	300
NOPP451200*06V9010		1207	518	50	6	19,10	4,30	274	522	627	600
NOPP451200*09V9010		1207	728	50	9	23,30	6,40	407	777	932	800
NOPP451500*04V9010		1507	378	50	4	16,20	3,50	231	440	528	500
NOPP451500*06V9010		1507	518	50	6	23,70	5,20	341	652	782	600
NOPP451500*09V9010		1507	728	50	9	34,90	7,90	508	969	1163	1200
NOPP451800*04V9010		1807	378	50	4	19,40	4,10	276	527	633	600
NOPP451800*06V9010		1807	518	50	6	28,20	6,20	409	781	937	800
NOPP451800*09V9010		1807	728	50	9	41,60	9,30	608	1161	1394	1200

● We can make custom dimensions, after technical analysis. | Putem executa dimensiuni speciale, în urma unei analize tehnice.  
The mentioned code is for hydronic version. | Codul menționat este pentru versiunea hidraulică.

Hydraulic connections/  
Conexiuni hidraulice\*\*



\* For other colours, put your desired RADOX colour code instead of 9010 (standard white). For more details, see page 194  
Pentru alte culori, se pune codul culorii RADOX dorite în locul codului 9010 (standard alb). Mai multe detalii la pag. 194

\*\* When you order, you must mention the type of connection you require. The price changes according to the requirements.  
Când comandați trebuie să menționați tipul de alimentare necesar. Prețul se modifică în funcție de cerințe.

\*\*\* NOVA PPMIX2 is the electric version of NOVA PP45. Please order accordingly.  
NOVA PPMIX2 este modelul electric al radiatorului NOVA PP45 și trebuie comandat cu aceasta denumire



# RC CONVECTORS

Valves are not included and must be ordered separately, if required.  
*Robineții nu sunt incluși și trebuie comandați separat, la cerere.*



# RC CONVECTORS

With a clean design, our RC convectors provide a very high heat output. Suitable for most environments - commercial, industrial and domestic installations, RC convectors are constructed from high grade steel tubes. Designed to provide comfort heating in applications where safety and hygiene are paramount, RC convectors are especially suitable for hospitals, care homes, day centres, playrooms, surgeries and nurseries. With their rounded corners, RC convectors are available in all our RAL colours.

Cu un design simplu, convectorii RC conferă o putere termică ridicată. Adaptabili oricărui spațiu - comercial, industrial, rezidențial - convectorii RC sunt realizați din elemente de oțel de înaltă calitate. Proiectați pentru a oferi confort termic în locații în care siguranța și igiena sunt primordiale, convectorii RC se recomandă pentru spitale, case de îngrijire, centre de zi, camere de joacă și creșe. Cu colțuri rotunjite, convectorii RC sunt disponibili vopsiți în orice culoare din gama RAL.

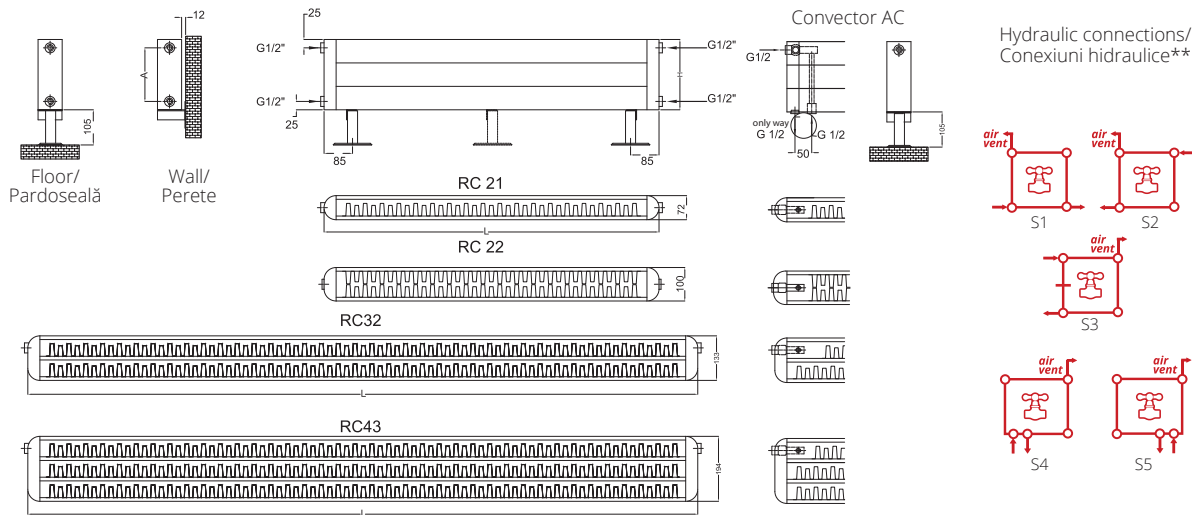

Max. working pressure/ Presiune max. de lucru 5.5 bar	Max. working temperature/ Temperatură max. de lucru 90°C	Mounting kit included/ Kit montaj inclus: K18 page 203	Factory pressure test/ Presiune de probă: 7 bar	Elements/Elemente: 70x11mm

Minimum height for RC CONVECTOR central connections is 140mm/  
Înălțimea minimă pentru convectorii RC cu atac central este 140mm.

Code/ Cod	Finish/ Finisaj	Height/ Înălțime (H)	Length/ Lățime (L)	Centres/ Interax (A)	No el/Nr elemente	Weight/ Greutate	Volume/ Volum	OUTPUT/PUTERE TERMICĂ (watt)				
								Δt=30°C	Δt=50°C	Δt=60°C	electric***	
								W	W	W	W	
21	CV21/140/1200V9010	RAL 9010 white/ alb*	140	1200	90	4	12,50	2,90	316	603	754	600
	RC21/140/1500V9010		140	1500	90	4	15,80	3,60	400	763	954	900
	CV21/210/1200V9010		210	1200	160	6	18,90	4,40	471	899	1124	1200
	CV21/210/1500V9010		210	1500	160	6	23,90	5,40	597	1139	1423	1500
	CV21/280/1200V9010		280	1200	230	8	25,30	5,90	626	1195	1494	1500
	CV21/280/1500V9010		280	1500	230	8	32,00	7,10	793	1514	1893	1500
22	CV22/140/1200V9010	RAL 9010 white/ alb*	140	1200	90	4	16,20	2,90	439	839	1048	900
	CV22/140/1500V9010		140	1500	90	4	20,60	3,60	560	1068	1335	1200
	CV22/210/1200V9010		210	1200	160	6	24,60	4,40	661	1262	1577	1500
	CV22/210/1500V9010		210	1500	160	6	31,30	5,40	843	1608	2010	1500
	CV22/280/1200V9010		280	1200	230	8	33,00	5,90	883	1685	2106	1500
	CV22/280/1500V9010		280	1500	230	8	41,90	7,10	1125	2148	2685	1500
32	CV32/140/1200V9010	RAL 9010 white/ alb*	140	1200	90	6	20,40	4,10	521	995	1244	1200
	CV32/140/1500V9010		140	1500	90	6	25,90	5,10	664	1267	1583	1500
	CV32/210/1200V9010		210	1200	160	9	30,80	6,20	784	1496	1870	1500
	CV32/210/1500V9010		210	1500	160	9	39,10	7,70	998	1905	2382	1500
	CV32/280/1200V9010		280	1200	230	12	41,30	8,30	1047	1997	2497	1500
	CV32/280/1500V9010		280	1500	230	12	56,10	10,80	1429	2727	3408	1500
43	CV43/140/1200V9010	RAL 9010 white/ alb*	140	1200	90	8	28,20	5,30	727	1387	1734	-
	CV43/140/1500V9010		140	1500	90	8	35,90	6,60	927	1770	2212	-
	CV43/210/1200V9010		210	1200	160	12	42,70	8,00	1097	2093	2617	-
	CV43/210/1500V9010		210	1500	160	12	54,40	9,90	1400	2672	3340	-
	CV43/280/1200V9010		280	1200	230	16	57,20	10,70	1467	2800	3499	-
	CV43/280/1500V9010		280	1500	230	16	72,80	13,30	1873	3575	4468	-

● We can make custom dimensions, after technical analysis. | Putem executa dimensiuni speciale, în urma unei analize tehnice.  
The mentioned code is for hydronic version. | Codul menționat este pentru versiunea hidraulică.

\* For other colours, put your desired RADOX colour code instead of 9010 (standard white). For more details, see page 194  
Pentru alte culori, se pune codul culorii RADOX dorite în locul codului 9010 (standard alb). Mai multe detalii la pag. 194

\*\* When you order, you must mention the type of connection you require. The price changes according to the requirements.  
Când comandați trebuie să menționați tipul de alimentare necesar. Prețul se modifică în funcție de cerințe.



# TOSCA 20

Valves are not included and must be ordered separately, if required.  
*Robineții nu sunt incluși și trebuie comandați separat, la cerere.*



# TOSCA 20

Constructed in steel to remain durable over time, TOSCA 20 is the ideal radiator for elegant spaces. Optimum quality, comfort, innovation and exclusive design: these are the foundations on which TOSCA 20 was created, a stylish and powerful radiator.

Realizat din oțel ca să rămână durabil în timp, TOSCA 20 este radiatorul ideal pentru spații elegante. Calitate optimă, confort, inovație și design exclusiv: acestea sunt bazele pe care a fost creat TOSCA 20, un radiator cu stil și puternic.

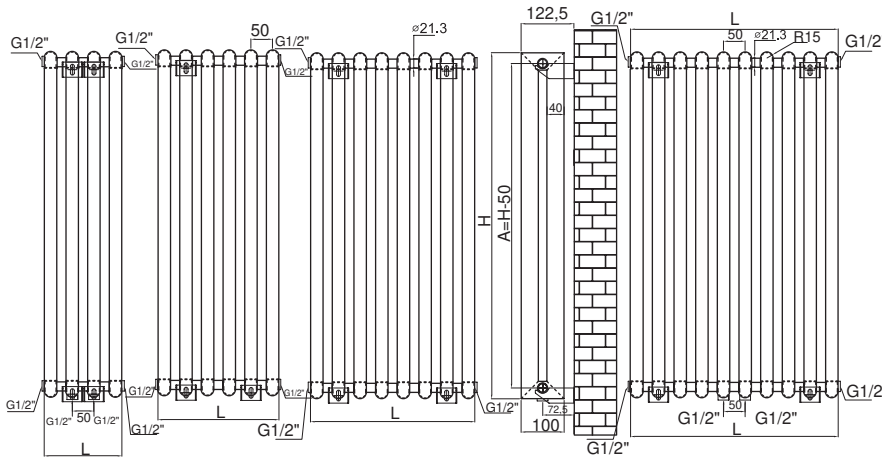

Max. working pressure/  
Presiune max. de lucru 10 bar



Max. working temperature/  
Temperatură max. de lucru 90°C



Mounting kit included/  
Kit montaj inclus: K15 page 203



Factory pressure test/  
Presiune de probă: 13 bar



Elements/Elemente:  
40x30mm

Code/ Cod	Finish / Finisaj	Height/ Înălțime (H)	Length/ Lățime (L)	Centres/ Interax (A)	No el/Nr elemente	Weight/ Greutate	Volume/ Volum	OUTPUT/PUTERE TERMICĂ (watt)		
								Δt=30°C	Δt=50°C	Δt=60°C
		mm	mm	mm	pcs	kg	l	W	W	W
MC20800*04V9010		800	180	750	4	9.69	6.50	232	446	558
MC20800*06V9010		800	280	750	6	14.56	9.20	348	670	838
MC20800*08V9010		800	380	750	8	19.42	12.50	464	893	1116
MC20800*10V9010		800	480	750	10	24.29	15.50	581	1117	1396
MC201500*04V9010		1500	180	1450	4	17.67	11.40	430	827	1024
MC201500*06V9010		1500	280	1450	6	26.53	16.95	645	1241	1551
MC201500*08V9010	RAL 9010 white/ alb*	1500	380	1450	8	35.38	22.60	860	1654	2068
MC201500*10V9010		1500	480	1450	10	44.24	28.50	1070	2058	2573
MC201800*04V9010		1800	180	1750	4	21.09	13.50	515	990	1238
MC201800*06V9010		1800	280	1750	6	31.66	20.25	772	1485	1856
MC201800*08V9010		1800	380	1750	8	42.22	26.95	1030	1981	2476
MC201800*10V9010		1800	480	1750	10	52.79	33.80	1288	2476	3095
MC202000*04V9010		2000	180	1950	4	23.37	14.95	571	1099	1374
MC202000*06V9010		2000	280	1950	6	35.08	22.50	857	1649	2061
MC202000*08V9010		2000	380	1950	8	46.78	30.10	1143	2198	2748
MC202000*10V9010		2000	480	1950	10	58.49	37.50	1429	2748	3435

● We can make custom dimensions, after technical analysis. | Putem executa dimensiuni speciale, în urma unei analize tehnice.

Hydraulic connections/  
Conexiuni hidraulice\*\*

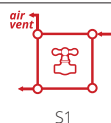

\* For other colours, put your desired RADOX colour code instead of 9010 (standard white). For more details, see page 194  
Pentru alte culori, se pune codul culorii RADOX dorite în locul codului 9010 (standard alb). Mai multe detalii la pag. 194

\*\* When you order, you must mention the type of connection you require. The price changes according to the requirements.  
Când comandați trebuie să menționați tipul de alimentare necesar. Prețul se modifică în funcție de cerințe.



# VERTICA D

Valves are not included and must be ordered separately, if required.  
*Robineții nu sunt incluși și trebuie comandați separat, la cerere.*



# VERTICA D

VERTICA D is all about clean lines, precise engineering and complete practicality. It looks fantastic in lounges, hallways or any other room. With towel hooks specifically designed for it, VERTICA D is the perfect complement to contemporary interiors with its minimal great aesthetic. Available in all RAL colour range and also in stainless steel.

VERTICA D înseamnă linii precise, inginerie excepțională și utilitate. Este un model ideal pentru holuri spațioase, saloane sau oricare altă cameră de locuit. Disponibil în orice culoare RAL sau inox, VERTICA D poate fi accesoriizat cu diferite agățătoare (robe hook) proiectate special pentru acest model.

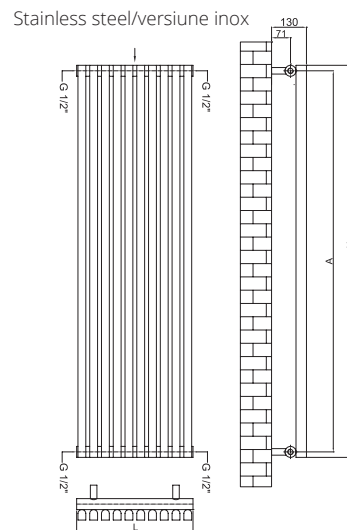
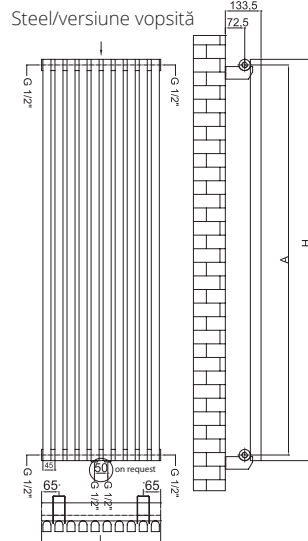

Max. working pressure/  
Presiune max. de lucru  
10 bar



Max. working temperature/  
Temperatură max. de lucru  
90°C



Mounting kit included/  
Kit montaj inclus:  
K12/15 page 203



Factory pressure test/  
Presiune de probă:  
13 bar



Elements/  
Elemente:  
40x30mm



Collectors/  
Colectori:  
Ø42mm

Code/ Cod	Finish / Finisaj	Height/ Înălțime (H)	Length/ Lățime (L)	Centres/ Interax (A)	No el/Nr elemente	Weight/ Greutate	Volume/ Volum	OUTPUT/PUTERE TERMICĂ (watt)		
								Δt=30°C	Δt=50°C	Δt=60°C
		mm	mm	mm	pcs	kg	l	W	W	W
VD1500*04RAL9010	RAL 9010 white/alb*	1500	175	1458	4	9,10	5,90	207	394	493
VD1500*06V9010		1500	265	1458	6	13,70	8,90	310	592	739
DE445/1500V9010		1500	445	1458	10	22,90	14,90	520	992	1240
DE535/1500V9010		1500	535	1458	12	27,50	17,80	623	1190	1487
DE625/1500V9010		1500	625	1458	14	32,10	20,80	727	1387	1734
DE720/1500V9010		1500	715	1458	16	36,60	23,80	830	1585	1981
VD1800*04RAL9010		1800	175	1758	4	10,80	7,00	245	468	585
VD1800*06V9010	1800	265	1758	6	16,20	10,50	368	703	879	
DE445/1800V9010	1800	445	1758	10	27,10	17,60	617	1178	1472	
DE535/1800V9010	1800	535	1758	12	32,50	21,10	740	1412	1765	
DE625/1800V9010	1800	625	1758	14	37,90	24,70	863	1647	2059	
DE720/1800V9010	1800	715	1758	16	43,30	28,20	986	1881	2352	
VD1500*04XL	Stainless steel /INOX	1500	175	1458	4	9,10	5,90	153	292	365
VD1500*06XL		1500	265	1458	6	13,70	8,90	230	438	548
VD1500*10XL		1500	445	1458	10	22,90	14,90	385	735	919
VD1800*04XL		1800	175	1758	4	10,80	7,00	182	347	434
VD1800*06XL		1800	265	1758	6	16,20	10,50	273	521	651
VD1800*10XL		1800	445	1758	10	27,10	17,60	457	872	1091

● We can make custom dimensions, after technical analysis. | Putem executa dimensiuni speciale, în urma unei analize tehnice.

Hydraulic connections/  
Conexiuni hidraulice\*\*



S1

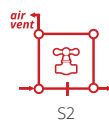

S2



S3



S4

\* For other colours, put your desired RADOX colour code instead of 9010 (standard white). For more details, see page 194  
Pentru alte culori, se pune codul culorii RADOX dorite în locul codului 9010 (standard alb). Mai multe detalii la pag. 194

\*\* When you order, you must mention the type of connection you require. The price changes according to the requirements.  
Când comandați trebuie să menționați tipul de alimentare necesar. Prețul se modifică în funcție de cerințe.

A vertical radiator with multiple dark grey vertical bars is mounted on a light grey wall. To its right is a round mirror with a white, scalloped frame and a gold inner ring. In the foreground, a brown leather armchair with a black and white patterned pillow is partially visible. The floor is light wood, and a patterned rug is at the bottom right.

# VERTICA D BI

Valves are not included and must be ordered separately, if required.  
*Robineții nu sunt incluși și trebuie comandați separat, la cerere.*





# VERTICA D BI

Our VERTICA D BI radiators are manufactured using state of the art welding technology, which gives a superior finish because the welds are virtually invisible. With its double configuration, VERTICA D BI boasts superior heat outputs, and can be accessorized with different shapes of towel and robe hooks.

*Radiatoarele VERTICA D BI sunt fabricate folosind o tehnologie unică de sudare la interior care oferă o mai bună finisare, astfel încât sudurile sunt, practic, invizibile. Are o configurație dublă, ceea ce îi oferă o putere termică sporită.*

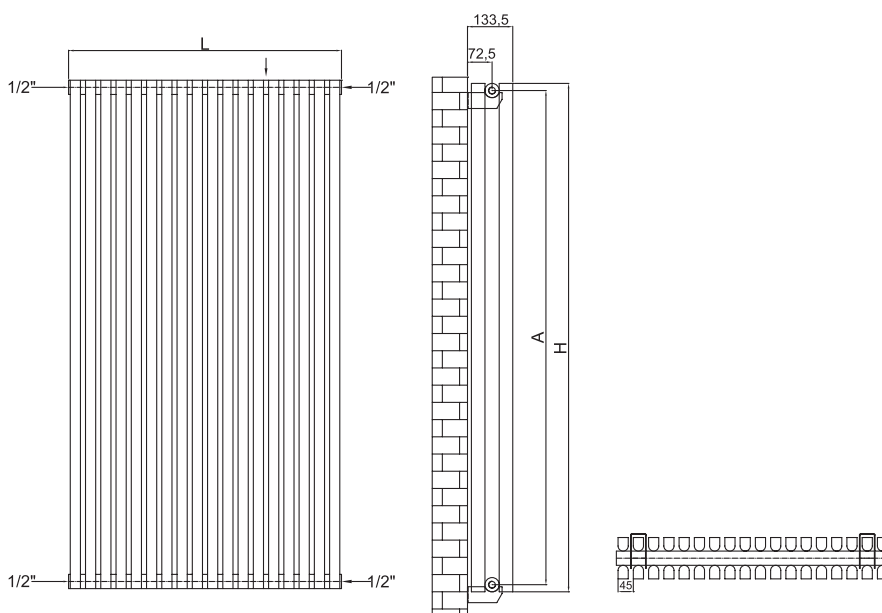

Max. working pressure/  
Presiune max. de lucru  
10 bar



Max. working temperature/  
Temperatură max. de lucru  
90°C



Mounting kit included/  
Kit montaj inclus:  
K15 page 203



Factory pressure test/  
Presiune de probă:  
13 bar



Elements/  
Elemente:  
40x30mm



Collectors/  
Colectori:  
Ø42mm

Code/ Cod	Finish / Finisaj	Height/ Înălțime (H)	Length/ Lățime (L)	Centres/ Interax (A)	No el/Nr elemente	Weight/ Greutate	Volume/ Volum	OUTPUT/PUTERE TERMICĂ (watt)		
								Δt=30°C	Δt=50°C	Δt=60°C
		mm	mm	mm	pcs	kg	l	W	W	W
VDB060/044.5V9010	RAL 9010 white/alb*	600	445	558	20	18,57	12,03	420	801	1001
VDB060/081V9010		600	815	558	36	33,44	21,66	756	1442	1803
VDB044.5/120V9010		1200	445	1158	20	35,38	23,04	809	1543	1929
VDB080.5/120V9010		1200	805	1158	36	63,70	41,49	1456	2778	3472
VDB044.5/150V9010		1500	445	1458	20	43,78	28,55	1003	1914	2393
VDB080.5/150V9010		1500	805	1458	36	78,83	51,40	1806	3446	4307
VDB044.5/180V9010		1800	445	1758	20	52,19	34,06	1197	2285	2856

We can make custom dimensions, after technical analysis. | Putem executa dimensiuni speciale, în urma unei analize tehnice.

Hydraulic connections/  
Conexiuni hidraulice\*\*

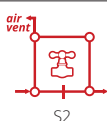
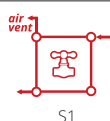

\* For other colours, put your desired RADOX colour code instead of 9010 (standard white). For more details, see page 194  
Pentru alte culori, se pune codul culorii RADOX dorite în locul codului 9010 (standard alb). Mai multe detalii la pag. 194

\*\* When you order, you must mention the type of connection you require. The price changes according to the requirements.  
Când comandați trebuie să menționați tipul de alimentare necesar. Prețul se modifică în funcție de cerințe.



## VERTICA D MIRROR

Valves are not included and must be ordered separately, if required.  
*Robineții nu sunt incluși și trebuie comandați separat, la cerere.*

# VERTICA D MIRROR

Our exquisite mirrored radiator provides warmth and comfort, and is accompanied by a full-length clear or bronze mirror to enhance and complement its beauty. An unique addition to your home, VERTICA D MIRROR demands attention yet retains a sense of practicality: high outputs, towel and robe hooks available on request, wide range of colour finishes.

*Un model care oferă căldură, confort și este completat de o superbă oglindă (finisaj bronz sau clasic). VERTICA D MIRROR cu siguranță va atrage atenția, fiind un radiator ornamental practic și robust. Poate fi personalizat având la dispoziție o mare gamă de culori și accesorii.*



Steel/versiune vopsită

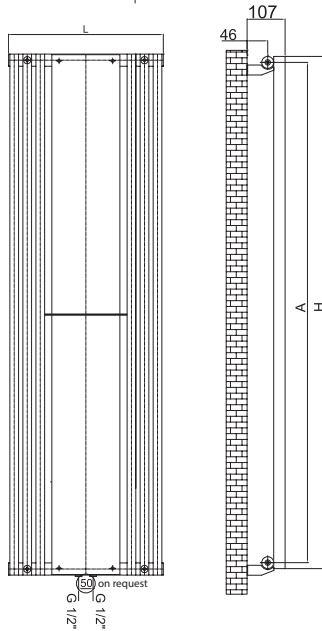

Stainless steel/versiune inox

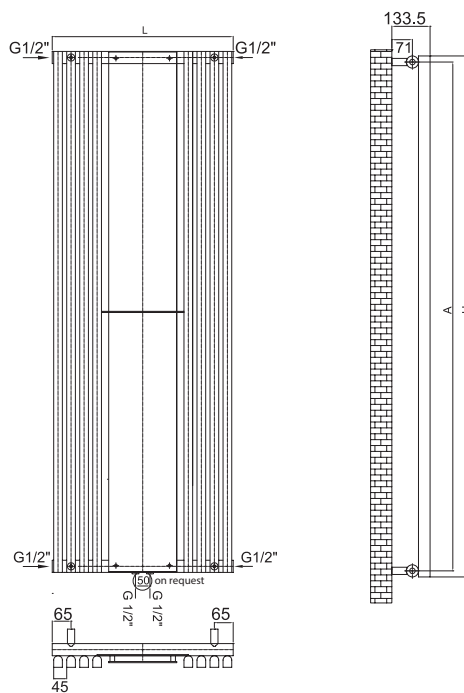

Max. working pressure/  
Presiune max. de lucru  
10 bar



Max. working temperature/  
Temperatură max. de lucru  
90°C



Mounting kit included/  
Kit montaj inclus:  
K22 page 203



Factory pressure test/  
Presiune de probă:  
13 bar



Elements/  
Elemente:  
40x30mm



Collectors/  
Colectori:  
Ø42mm

Code/ Cod	Finish / Finisaj	Height/ Înălțime (H)	Length/ Lățime (L)	Centres/ Interax (A)	No el/Nr elemente	Weight/ Greutate	Volume/ Volum	OUTPUT/PUTERE TERMICĂ (watt)		
								Δt=30°C	Δt=50°C	Δt=60°C
		mm	mm	mm	pcs	kg	l	W	W	W
DEO535/1500V9010	RAL 9010 white/alb*	1500	535	1458	6	14,70	9,50	329	627	784
DEO625/1500V9010		1500	625	1458	8	19,30	12,40	432	825	1031
DEO535/1800V9010		1800	535	1758	6	17,20	11,10	387	739	923
DEO625/1800V9010		1800	625	1758	8	22,60	14,60	510	973	1216
DEO053.5/150XL	Stainless steel /INOX	1500	535	1458	6	14,70	9,50	243	369	581
DEO062.5/150XL		1500	625	1458	8	19,30	12,40	320	485	764
DEO053.5/180XL		1800	535	1758	6	17,20	11,10	287	434	684
DEO062.5/180XL		1800	625	1758	8	22,60	14,60	378	572	901

● We can make custom dimensions, after technical analysis. | Putem executa dimensiuni speciale, în urma unei analize tehnice.

Hydraulic connections/  
Conexiuni hidraulice\*\*

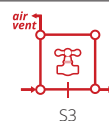
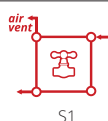

\* For other colours, put your desired RADOX colour code instead of 9010 (standard white). For more details, see page 194  
Pentru alte culori, se pune codul culorii RADOX dorite în locul codului 9010 (standard alb). Mai multe detalii la pag. 194

\*\* When you order, you must mention the type of connection you require. The price changes according to the requirements.  
Când comandați trebuie să menționați tipul de alimentare necesar. Prețul se modifică în funcție de cerințe.



# VESTA

Valves are not included and must be ordered separately, if required.  
*Robineții nu sunt incluși și trebuie comandați separat, la cerere.*



# VESTA

This modular radiator is conveniently versatile allowing for any number of elements to meet your designing needs. Deploy your imagination and experiment with any variety of shapes and colours. Regardless of the combination the final product will be remarkable.

VESTA are un design flexibil, poate fi fără dificultate personalizat astfel încât să se potrivească în orice design de interior. Inox, cromat, vopsit în nuanțe RAL la alegere, VESTA va arăta impresionant oricum.

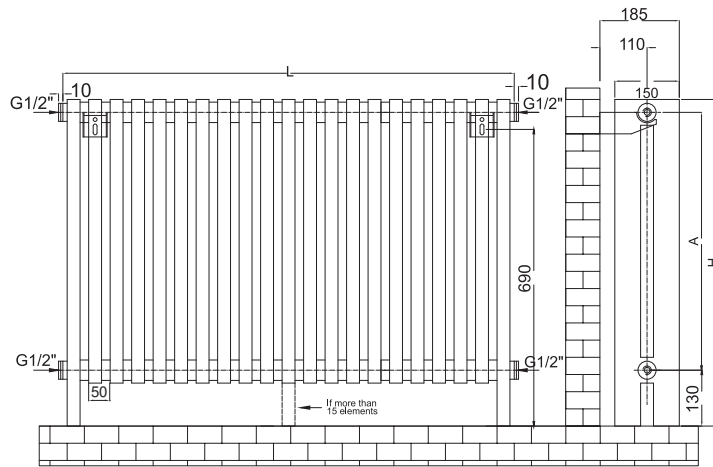

Max. working pressure/  
Presiune max. de lucru 7 bar



Max. working temperature/  
Temperatură max. de lucru 90°C



Mounting kit included/  
Kit montaj inclus: K23 page 203



Factory pressure test/  
Presiune de probă: 10 bar



Elements/Elemente:  
60x30mm

Code/ Cod	Finish / Finisaj	Height/ Înălțime (H) mm	Length/ Lățime (L) mm	Centres/ Interax (A) mm	No el/Nr elemente pcs	Weight/ Greutate kg	Volume/ Volum l	OUTPUT/PUTERE TERMICĂ (watt)		
								Δt=30°C	Δt=50°C	Δt=60°C
PGXL30N600*12V9010	RAL 9010 white/ alb*	600	600	440	12	30,30	20,70	592	1130	1412
PGXL30N600*14V9010		600	700	440	14	34,40	24,10	688	1312	1640
PGXL30N600*18V9010		600	900	440	18	42,60	30,80	879	1677	2096
PGXL30N800*12V9010		800	600	640	12	36,00	28,10	818	1562	1952
PGXL30N800*14V9010		800	700	640	14	41,70	32,70	952	1816	2270
PGXL30N800*18V9010		800	900	640	18	53,20	41,90	1218	2325	2906
PGXL30N1200*12V9010		1200	600	1040	12	55,70	42,90	1271	2426	3032
PGXL30N1200*14V9010		1200	700	1040	14	64,70	49,90	1480	2824	3530
PGXL30N1200*18V9010		1200	900	1040	18	82,70	64,00	1897	3621	4526
PGXL30N600*12CR		Chrome / Cromat	600	600	440	12	30,30	20,70	455	869
PGXL30N600*14CR	600		700	440	14	34,40	24,10	529	1009	1262
PGXL30N600*18CR	600		900	440	18	42,60	30,80	676	1290	1613
PGXL30N800*12CR	800		600	640	12	36,00	28,10	629	1201	1502
PGXL30N800*14CR	800		700	640	14	41,70	32,70	732	1397	1746
PGXL30N800*18CR	800		900	640	18	53,20	41,90	937	1789	2236
PGXL30N1200*12CR	1200		600	1040	12	55,70	42,90	978	1866	2332
PGXL30N1200*14CR	1200		700	1040	14	64,70	49,90	1138	2172	2716
PGXL30N1200*18CR	1200		900	1040	18	82,70	64,00	1460	2785	3482
PGXL600*12XL	Stainless steel / INOX		600	600	440	12	30,30	20,70	438	837
PGXL600*14XL		600	700	440	14	34,40	24,10	509	972	1215
PGXL600*18XL		600	900	440	18	42,60	30,80	651	1242	1553
PGXL800*12XL		800	600	640	12	36,00	28,10	606	1157	1446
PGXL800*14XL		800	700	640	14	41,70	32,70	705	1345	1682
PGXL800*18XL		800	900	640	18	53,20	41,90	902	1722	2153
PGXL1200*12XL		1200	600	1040	12	55,70	42,90	942	1797	2246
PGXL1200*14XL		1200	700	1040	14	64,70	49,90	1096	2092	2615
PGXL1200*18XL	1200	900	1040	18	82,70	64,00	1406	2682	3353	

● We can make custom dimensions, after technical analysis. | Putem executa dimensiuni speciale, în urma unei analize tehnice.

Hydraulic connections/  
Conexiuni hidraulice\*\*

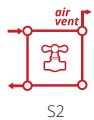

\* For other colours, put your desired RADOX colour code instead of 9010 (standard white). For more details, see page 194  
Pentru alte culori, se pune codul culorii RADOX dorite în locul codului 9010 (standard alb). Mai multe detalii la pag. 194

\*\* When you order, you must mention the type of connection you require. The price changes according to the requirements.  
Când comandați trebuie să menționați tipul de alimentare necesar. Prețul se modifică în funcție de cerințe.



# VESTA UNO

Valves are not included and must be ordered separately, if required.  
*Robineții nu sunt incluși și trebuie comandați separat, la cerere.*

# VESTA UNO

With its tubular construction, VESTA UNO makes an impact on any interior décor. Floor or wall mounted, VESTA UNO is suitable for home or workspaces, offering superb heat delivery. It can be personalized with finishes such as colours combination, chrome and stainless steel.

Prin construcția sa compactă, VESTA UNO este o prezență spectaculoasă în orice ambient. Poate fi montat vertical pe perete sau pe podea, VESTA UNO este disponibil în variantă vopsită, cromată sau inox.

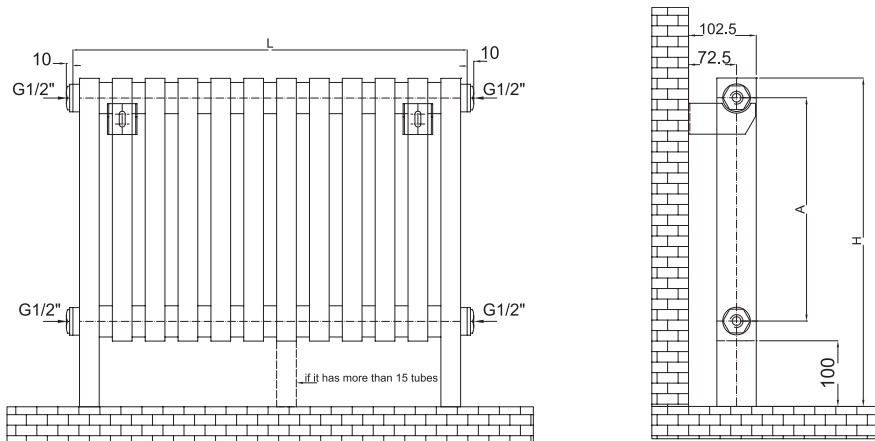
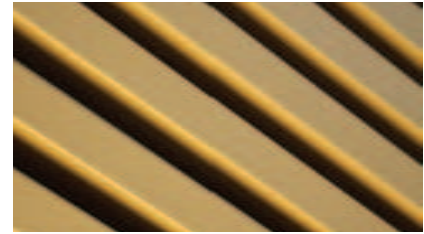

Max. working pressure/  
Presiune max. de lucru  
7 bar



Max. working temperature/  
Temperatură max. de lucru  
90°C



Mounting kit included/  
Kit montaj inclus:  
K15 page 203



Factory pressure test/  
Presiune de probă:  
10 bar



Elements/  
Elemente:  
60x30mm



Collectors/  
Colectori:  
Ø42mm

Code/ Cod	Finish / Finisaj	Height/ Înălțime (H)	Length/ Lățime (L)	Centres/ Interax (A)	No el/Nr elemente	Weight/ Greutate	Volume/ Volum	OUTPUT/PUTERE TERMICĂ (watt)		
								Δt=30°C	Δt=50°C	Δt=60°C
		mm	mm	mm	pcs	kg	l	W	W	W
TK30N800*12V9010	RAL 9010 white/ alb*	800	600	640	12	19,40	13,40	434	828	1035
TK30N800*14V9010		800	700	640	14	22,60	15,60	505	963	1204
TK30N800*18V9010		800	900	640	18	28,90	20,00	646	1233	1541
TK30N1200*12V9010		1200	600	1040	12	29,20	20,80	672	1282	1602
TK30N1200*14V9010		1200	700	1040	14	34,00	24,20	782	1492	1866
TK30N1200*18V9010		1200	900	1040	18	43,60	31,10	1003	1913	2392
VESTA1800*12V9010		1800	600	1640	12	44,00	31,90	1028	1962	2453
VESTA1800*14V9010		1800	700	1640	14	51,20	37,20	1198	2286	2858
TK30N1800*18V9010		1800	900	1640	18	65,80	47,70	1537	2934	3668
TK30N800*12CR	Chrome / Cromat	800	600	640	12	19,40	13,40	334	637	796
TK30N800*14CR		800	700	640	14	22,60	15,60	388	741	926
TK30N800*18CR		800	900	640	18	28,90	20,00	497	948	1186
TK30N1200*12CR		1200	600	1040	12	29,20	20,80	517	986	1233
TK30N1200*14CR		1200	700	1040	14	34,00	24,20	602	1148	1435
TK30N1200*18CR		1200	900	1040	18	43,60	31,10	771	1472	1840
TK30N1800*12CR		1800	600	1640	12	44,00	31,90	791	1509	1887
TK30N1800*14CR		1800	700	1640	14	51,20	37,20	922	1759	2198
TK30N1800*18CR		1800	900	1640	18	65,80	47,70	1183	2257	2821
TK30B800*12XL	Stainless steel / INOX	800	600	640	12	19,40	13,40	322	614	767
TK30B800*14XL		800	700	640	14	22,60	15,60	374	714	892
TK30B800*18XL		800	900	640	18	28,90	20,00	479	913	1142
TK30B1200*12XL		1200	600	1040	12	29,20	20,80	498	950	1187
TK30B1200*14XL		1200	700	1040	14	34,00	24,20	579	1106	1382
TK30B1200*18XL		1200	900	1040	18	43,60	31,10	743	1417	1772
TK30B1800*12XL		1800	600	1640	12	44,00	31,90	762	1454	1817
TK30B1800*14XL		1800	700	1640	14	51,20	37,20	887	1694	2117
TK30B1800*18XL		1800	900	1640	18	65,80	47,70	1139	2173	2717

● We can make custom dimensions, after technical analysis. | Putem executa dimensiuni speciale, în urma unei analize tehnice.

Hydraulic connections/  
Conexiuni hidraulice\*\*

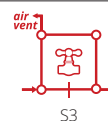
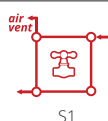

\* For other colours, put your desired RADOX colour code instead of 9010 (standard white). For more details, see page 194  
Pentru alte culori, se pune codul culorii RADOX dorite în locul codului 9010 (standard alb). Mai multe detalii la pag. 194

\*\* When you order, you must mention the type of connection you require. The price changes according to the requirements.  
Când comandați trebuie să menționați tipul de alimentare necesar. Prețul se modifică în funcție de cerințe.



# WAVE

Valves are not included and must be ordered separately, if required.  
*Robineții nu sunt incluși și trebuie comandați separat, la cerere.*





# WAVE

A luxury radiator, WAVE fills any room with warmth and elegance. With slim flat rectangular pipes waving back and forth, WAVE is available as a vertical or horizontal radiator, in all RAL range finishing colours.

Un radiator cu adevărat elegant care oferă căldură și rafinament, WAVE este disponibil în orice culoare RAL. Cu elementii săi plați și arcuiți, WAVE este disponibil atât în variantă verticală, cât și orizontală.

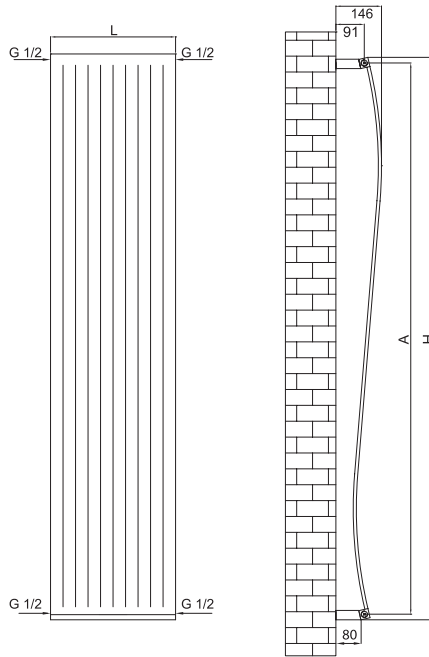

Max. working pressure/  
Presiune max. de lucru  
7 bar



Max. working temperature/  
Temperatură max. de lucru  
90°C



Mounting kit included/  
Kit montaj inclus:  
K26 page 203



Factory pressure test/  
Presiune de probă:  
10 bar



Elements/  
Elemente:  
40x10mm



Collectors/  
Colectori:  
30x30mm

Code/ Cod	Finish / Finisaj	Height/ Înălțime (H) mm	Length/ Lățime (L) mm	Centres/ Interax (A) mm	No el/Nr elemente pcs	Weight/ Greutate kg	Volume/ Volum l	OUTPUT/PUTERE TERMICĂ (watt)		
								Δt=30°C	Δt=50°C	Δt=60°C
WA850*10V9010	RAL 9010 white/ alb*	850	400	814	10	10,40	2,80	244	465	581
WA850*13V9010		850	520	814	13	13,50	3,60	317	605	756
WA850*15V9010		850	600	814	15	15,60	4,10	365	698	872
WA1200*10V9010		1200	400	1164	10	14,30	3,70	335	640	800
WA1200*13V9010		1200	520	1164	13	18,50	4,80	436	832	1040
WA1200*15V9010		1200	600	1164	15	21,40	5,50	503	960	1200
WA1500*10V9010		1500	400	1492	10	17,60	4,40	414	790	988
WA1500*13V9010		1500	520	1492	13	22,90	5,80	539	1027	1284
WA1500*15V9010		1500	600	1492	15	26,40	6,70	621	1185	1481
WA1800*10V9010		1800	400	1764	10	20,90	5,20	493	940	1175
WA1800*13V9010		1800	520	1764	13	27,20	6,80	640	1222	1528
WA1800*15V9010		1800	600	1764	15	31,40	7,80	739	1410	1763

☛ We can make custom dimensions, after technical analysis. | Putem executa dimensiuni speciale, în urma unei analize tehnice.

Hydraulic connections  
for vertical version/  
Conexiuni hidraulice  
versiune verticală\*\*

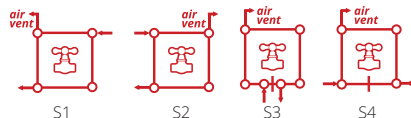

Hydraulic connections  
for horizontal version/  
Conexiuni hidraulice  
versiune orizontală\*\*

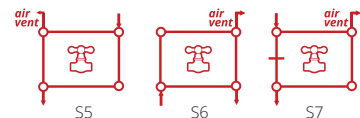

\* For other colours, put your desired RADOX colour code instead of 9010 (standard white). For more details, see page 194  
Pentru alte culori, se pune codul culorii RADOX dorite în locul codului 9010 (standard alb). Mai multe detalii la pag. 194

\*\* When you order, you must mention the type of connection you require. The price changes according to the requirements.  
Când comandați trebuie să menționați tipul de alimentare necesar. Prețul se modifică în funcție de cerințe.



# CELSIUS

Valves are not included and must be ordered separately, if required.  
Robineții nu sunt incluși și trebuie comandați separat, la cerere.

# CELSIUS

Perfect for any interior, CELSIUS is a practical and cost effective towel rail, available in a wide range of RAL colours and chrome plated.

Perfect pentru orice interior, CELSIUS este un radiator de baie standard, practic și rentabil, disponibil într-o gamă largă de culori RAL și în versiune cromată.

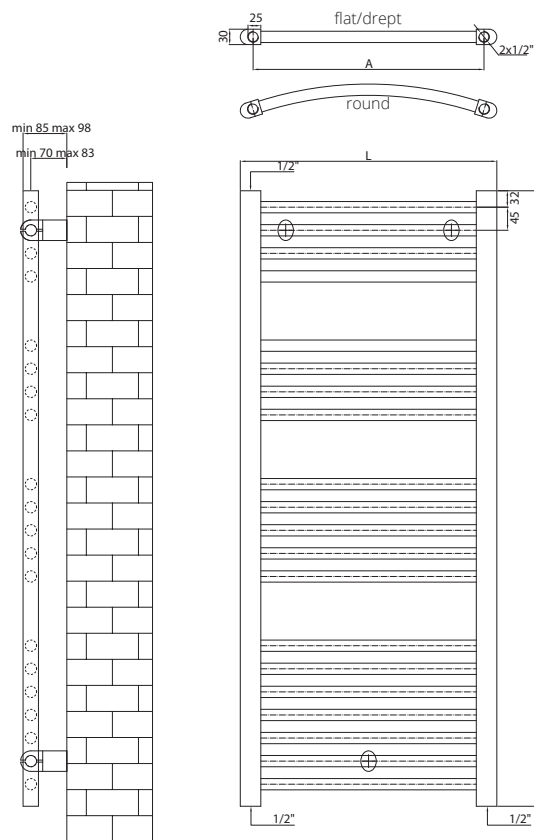

Max. working pressure/  
Presiune max. de lucru  
7 bar



Max. working temperature/  
Temperatură max. de lucru  
90°C



Mounting kit included/  
Kit montaj inclus:  
K05 page 203



Factory pressure test/  
Presiune de probă:  
10 bar



Elements/  
Elemente:  
Ø22mm



Collectors/  
Colectori:  
40x30mm

Code/ Cod	Finish / Finisaj	Height/ Înălțime (H) mm	Length/ Lățime (L) mm	Centres/ Interax (A) mm	No el/Nr elemente pcs	Weight/ Greutate kg	Volume/ Volum l	OUTPUT/PUTERE TERMICĂ (watt)			
								Δt=30°C W	Δt=50°C W	Δt=60°C W	electric W
CEL050/120V9010	RAL 9010 white/ alb*	1200	500	450	20	7,79	4,85	224	430	538	500
CEL060/120V9010		1200	600	550	20	8,83	5,48	258	496	620	600
CEL050/147V9010		1470	500	450	24	9,42	5,87	270	519	649	600
CEL060/147V9010		1470	600	550	24	10,67	6,62	311	598	747	600

● We can make custom dimensions, after technical analysis. | Putem executa dimensiuni speciale, în urma unei analize tehnice.  
The mentioned code is for flat and hydronic version. | Codul menționat este doar pentru versiunea dreaptă și hidraulică.

Hydraulic connections/  
Conexiuni hidraulice\*\*



\* For other colours, put your desired RADOX colour code instead of 9010 (standard white). For more details, see page 194  
Pentru alte culori, se pune codul culorii RADOX dorite în locul codului 9010 (standard alb). Mai multe detalii la pag. 194

\*\* When you order, you must mention the type of connection you require. The price changes according to the requirements.  
Când comandați trebuie să menționați tipul de alimentare necesar. Prețul se modifică în funcție de cerințe.



# SCALAN

Valves are not included and must be ordered separately, if required.  
*Robineții nu sunt incluși și trebuie comandați separat, la cerere.*

# SCALA N

SCALA N is a good looking radiator which won't steal the show, just will keep you and your towels warm all day. Available in any colour and chrome plated. In its round version, SCALA N ROUND is a elegant towel rail radiator, its gently curving tubes work together to combine aesthetic appeal with efficient drying space.

SCALA N este un radiator emblematic, practic și util, extrem de eficient în încălzirea camerei și a prosoapelor, disponibil în orice culoare și cromat. În varianta round, SCALA N ROUND combină aspectul estetic cu utilitatea, beneficiind datorită elementelor săi curbați, de un spațiu de depozitare și încălzire prosoape eficient.

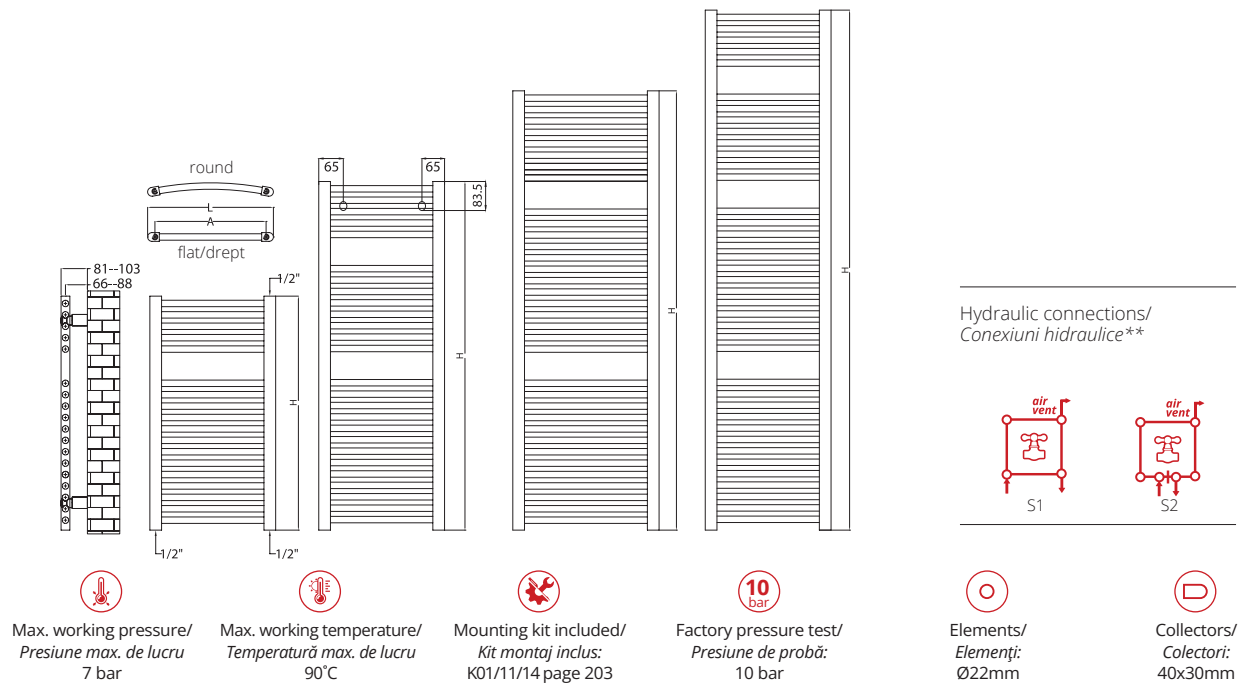
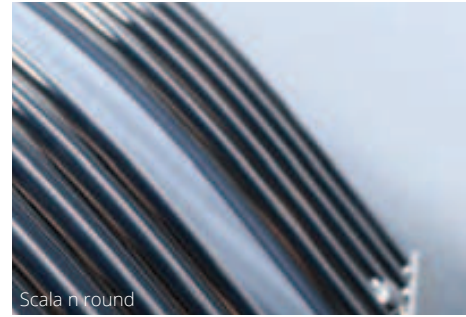

Code/ Cod	Finish / Finisaj	Height/ Înălțime (H)	Length/ Lățime (L)	Centres/ Interax (A)	No el/Nr elementi	Weight/ Greutate	Volume/ Volum	OUTPUT/PUTERE TERMICĂ (watt)				
								Δt=30°C	Δt=50°C	Δt=60°C	electric	
		mm	mm	mm	pcs	kg	l	W	W	W	w	
SC040/080V9010N	RAL 9010 white/alb*	800	400	350	18	5,52	3,28	166	316	393	300	
SC045/080V9010N		800	450	400	18	6,00	3,60	179	342	426	300	
SC050/080V9010N		800	500	450	18	6,50	3,80	200	381	475	500	
SC060/080V9010N		800	600	550	18	9,40	5,20	231	440	548	500	
SC040/120V9010N		1200	400	350	26	8,00	4,80	424	461	574	600	
SC045/120V9010N		1200	450	400	26	8,70	5,20	261	499	620	600	
SC050/120V9010N		1200	500	450	26	9,40	5,60	286	546	679	600	
SC060/120V9010N		1200	600	550	26	10,70	6,40	340	649	808	900	
SC045/150V9010N		1500	450	400	34	11,10	6,70	344	656	817	900	
SC050/150V9010N		1500	500	450	34	12,00	7,20	376	718	893	900	
SC060/150V9010N		1500	600	550	34	13,80	8,30	441	841	1047	900	
SC045/180V9010N		1800	450	400	39	12,90	7,80	398	760	946	900	
SC050/180V9010N		1800	500	450	39	13,90	8,40	406	775	964	900	
SC060/180V9010N		1800	600	550	39	15,90	9,60	509	972	1209	1200	
SC040/080CRN		Chrome / Cromat	800	400	350	18	5,50	3,30	127	243	303	300
SC045/080CRN			800	450	400	18	6,00	3,60	138	263	328	300
SC050/080CRN			800	500	450	18	6,50	3,80	154	293	365	500
SC060/080CRN			800	600	550	18	9,40	5,20	177	339	421	500
SC040/120CRN	1200		400	350	26	8,00	4,80	186	355	441	600	
SC045/120CRN	1200		450	400	26	8,70	5,20	201	384	477	600	
SC050/120CRN	1200		500	450	26	9,40	5,60	220	420	522	600	
SC060/120CRN	1200		600	550	26	10,70	6,40	262	499	621	900	
SC045/150CRN	1500		450	400	34	11,10	6,70	265	505	628	900	
SC050/150CRN	1500		500	450	34	12,00	7,20	289	552	687	900	
SC060/150CRN	1500		600	550	34	13,80	8,30	339	647	805	900	
SC045/180CRN	1800		450	400	39	12,90	7,80	306	585	727	900	
SC050/180CRN	1800		500	450	39	13,90	8,40	312	596	742	900	
SC060/180CRN	1800		600	550	39	15,90	9,60	392	748	930	1200	

● We can make custom dimensions, after technical analysis. | Putem executa dimensiuni speciale, în urma unei analize tehnice. The mentioned code is for flat and hydronic version. | Codul menționat este doar pentru versiunea dreaptă și hidraulică.

\* For other colours, put your desired RADOX colour code instead of 9010 (standard white). For more details, see page 194. Pentru alte culori, se pune codul culorii RADOX dorite în locul codului 9010 (standard alb). Mai multe detalii la pag. 194.

\*\* When you order, you must mention the type of connection you require. The price changes according to the requirements. Când comandați trebuie să menționați tipul de alimentare necesar. Prețul se modifică în funcție de cerințe.



# SUNIT P100

Valves are not included and must be ordered separately, if required.  
*Robineții nu sunt incluși și trebuie comandați separat, la cerere.*

# SUNIT P100

SUNIT P100 has a classic elegance, a popular choice for a straight and simple towel rail. Available in chrome and RAL colours, SUNIT P100 is a practical addition to any kitchen or bathroom interior.

*SUNIT P100 are o eleganță clasică, o alegere populară pentru un port-prosop drept și simplu. Disponibil în finisaj cromat și în culori RAL, SUNIT P100 este o completare practică a oricărei bucătării sau săli de baie.*

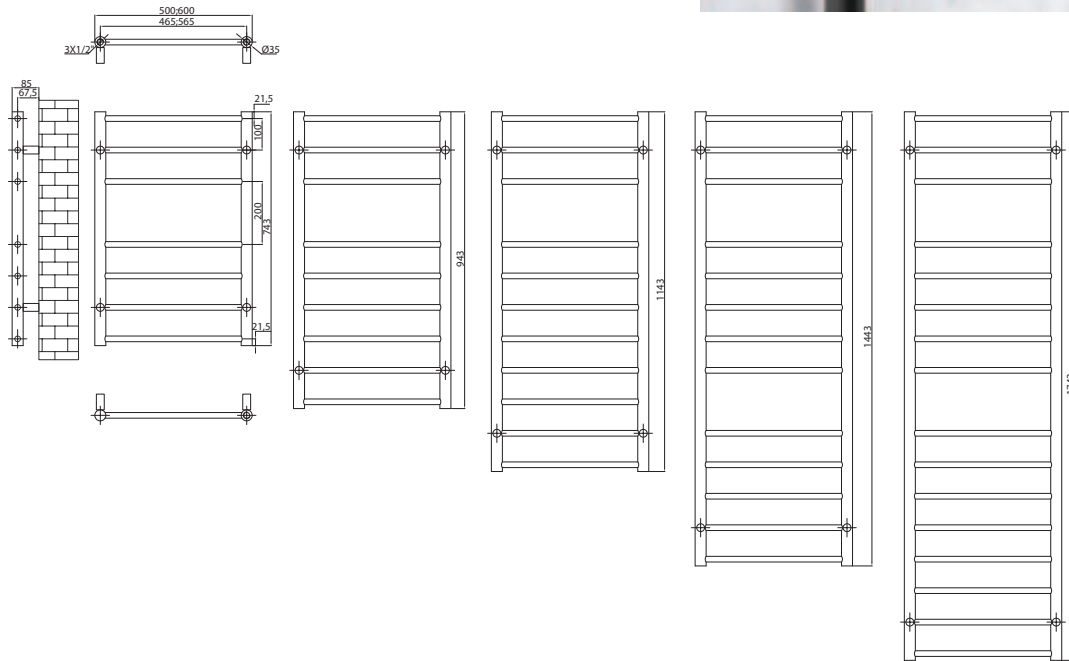

Max. working pressure/  
Presiune max. de lucru  
7 bar



Max. working temperature/  
Temperatură max. de lucru  
90°C



Mounting kit included/  
Kit montaj inclus:  
K13 page 203



Factory pressure test/  
Presiune de probă:  
10 bar



Elements/  
Elemente:  
Ø18mm



Collectors/  
Colectori:  
Ø35mm

Code/ Cod	Finish / Finisaj	Height/ Înălțime (H)	Length/ Lățime (L)	Centres/ Interax (A)	No el/Nr elementi	Weight/ Greutate	Volume/ Volum	OUTPUT/PUTERE TERMICĂ (watt)			
								Δt=30°C	Δt=50°C	Δt=60°C	electric
		mm	mm	mm	pcs	kg	l	W	W	W	w
SUNIT050/074.3V9010	RAL 9010 white/alb*	743	500	465	7	3.12	1.81	87	167	208	120
SUNIT060/074.3V9010		743	600	565	7	3.41	1.95	98	187	233	120
SUNIT050/094.3V9010		943	500	465	9	3.98	2.31	112	213	266	300
SUNIT060/094.3V9010		943	600	565	9	4.35	2.49	125	239	298	300
SUNIT050/114.3V9010		1143	500	465	11	4.84	2.81	136	259	324	300
SUNIT060/114.3V9010		1143	600	565	11	5.30	3.03	152	291	363	300
SUNIT050/144.3V9010		1443	500	465	13	5.95	3.47	166	317	396	300
SUNIT060/144.3V9010		1443	600	565	13	6.49	3.73	185	354	442	300
SUNIT050/174.3V9010		1743	500	465	16	7.24	4.22	202	386	483	500
SUNIT060/174.3V9010		1743	600	565	16	7.91	4.54	223	432	540	500
SUNIT050/074.3CR	Chrome / Cromat	743	500	465	7	3.12	1.81	67	128	160	120
SUNIT060/074.3CR		743	600	565	7	3.41	1.95	75	144	180	120
SUNIT050/094.3CR		943	500	465	9	3.98	2.31	86	164	205	300
SUNIT060/094.3CR		943	600	565	9	4.35	2.49	96	184	229	300
SUNIT050/114.3CR		1143	500	465	11	4.84	2.81	105	199	249	300
SUNIT060/114.3CR		1143	600	565	11	5.30	3.03	117	224	279	300
SUNIT050/144.3CR		1443	500	465	13	5.95	3.47	128	244	304	300
SUNIT060/144.3CR		1443	600	565	13	6.49	3.73	143	272	340	300
SUNIT050/174.3CR		1743	500	465	16	7.24	4.22	156	297	371	500
SUNIT060/174.3CR		1743	600	565	16	7.91	4.54	174	332	415	500

⊕ We can make custom dimensions, after technical analysis. | Putem executa dimensiuni speciale, în urma unei analize tehnice.  
The mentioned code is for hydronic version. | Codul menționat este pentru versiunea hidraulică.

Hydraulic connections/  
Conexiuni hidraulice\*\*



\* For other colours, put your desired RADOX colour code instead of 9010 (standard white). For more details, see page 194  
Pentru alte culori, se pune codul culorii RADOX dorite în locul codului 9010 (standard alb). Mai multe detalii la pag. 194

\*\* When you order, you must mention the type of connection you require. The price changes according to the requirements.  
Când comandați trebuie să menționați tipul de alimentare necesar. Prețul se modifică în funcție de cerințe.



# APOLLO

Valves are not included and must be ordered separately, if required.  
*Robineții nu sunt incluși și trebuie comandați separat, la cerere.*



# APOLLO

APOLLO is a practical and attractive towel rail radiator. Its rounded columns which support contrasting flat panelled piping make it easy on the eyes. Available in sleek chrome and all RAL colours.

APOLLO este un radiator port-prosop, practic și atractiv. Contrastul dintre colectorii rotunzi și elementii ovali creează un efect vizual spectaculos. Este disponibil în finisaj crom și orice culoare RAL.

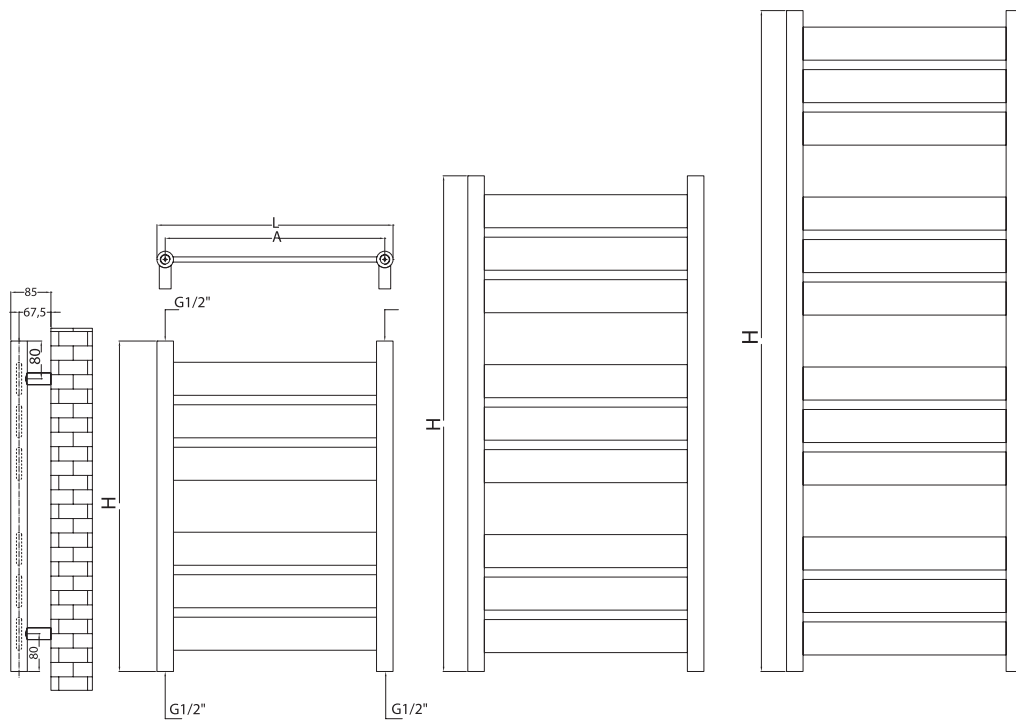

Max. working pressure/  
Presiune max. de lucru  
4 bar



Max. working temperature/  
Temperatură max. de lucru  
90°C



Mounting kit included/  
Kit montaj inclus:  
K02 page 203



Factory pressure test/  
Presiune de probă:  
5.2 bar



Elements/  
Elemente:  
70x11mm



Collectors/  
Colectori:  
Ø35mm

Code/ Cod	Finish / Finisaj	Height/ Înălțime (H) mm	Length/ Lățime (L) mm	Centres/ Interax (A) mm	No el/Nr elemente pcs	Weight/ Greutate kg	Volume/ Volum l	OUTPUT/PUTERE TERMICĂ (watt)			
								Δt=30°C W	Δt=50°C W	Δt=60°C W	electric w
PL050/070V9010	RAL 9010 white/alb*	700	500	465	6	6,50	2,50	141	270	337	300
PL050/105V9010KE		1050	500	465	9	9,80	3,70	164	313	391	300
PL050/140V9010KE		1400	500	465	12	13,00	4,90	212	404	505	500
PL050/070CKE	Chrome / Cromat	700	500	465	6	6,50	2,50	109	208	260	300
PL050/105CKE		1050	500	465	9	9,80	3,70	126	241	301	300
PL050/140CKE		1400	500	465	12	13,00	4,90	163	311	389	500

● We can make custom dimensions, after technical analysis. | Putem executa dimensiuni speciale, în urma unei analize tehnice.  
The mentioned code is for hydronic version. | Codul menționat este pentru versiunea hidraulică.

Hydraulic connections/  
Conexiuni hidraulice\*\*



S1



S2

\* For other colours, put your desired RADOX colour code instead of 9010 (standard white). For more details, see page 194  
Pentru alte culori, se pune codul culorii RADOX dorite în locul codului 9010 (standard alb). Mai multe detalii la pag. 194

\*\* When you order, you must mention the type of connection you require. The price changes according to the requirements.  
Când comandați trebuie să menționați tipul de alimentare necesar. Prețul se modifică în funcție de cerințe.



# APOLLO FLEXI

Valves are not included and must be ordered separately, if required.  
*Robineții nu sunt incluși și trebuie comandați separat, la cerere.*



# APOLLO FLEXI

Thanks to its innovative design, APOLLO FLEXI generates warmth and homogeneous heating in bathrooms, kitchens, laundry rooms, foyers and any other room, benefiting of hot water through all the towel bars, including the flexible element. APOLLO FLEXI is very efficient and easy on the eyes, yet its biggest advantage is that drying the towel will not slow down the convection of the movement of air through the radiator for heating the room.

*Datorită designului inovator, APOLLO FLEXI generează căldură și încălzește uniform băi, bucătării, spălătorii sau orice altă cameră, beneficiind de apă caldă prin toți elementii radiatorului, inclusiv prin elementul flexibil. APOLLO FLEXI este un radiator eficient și spectaculos, dar marelui avantaj este că uscarea prosopului nu va încetini convecția căldurii generate de radiator în mediul ambiant.*

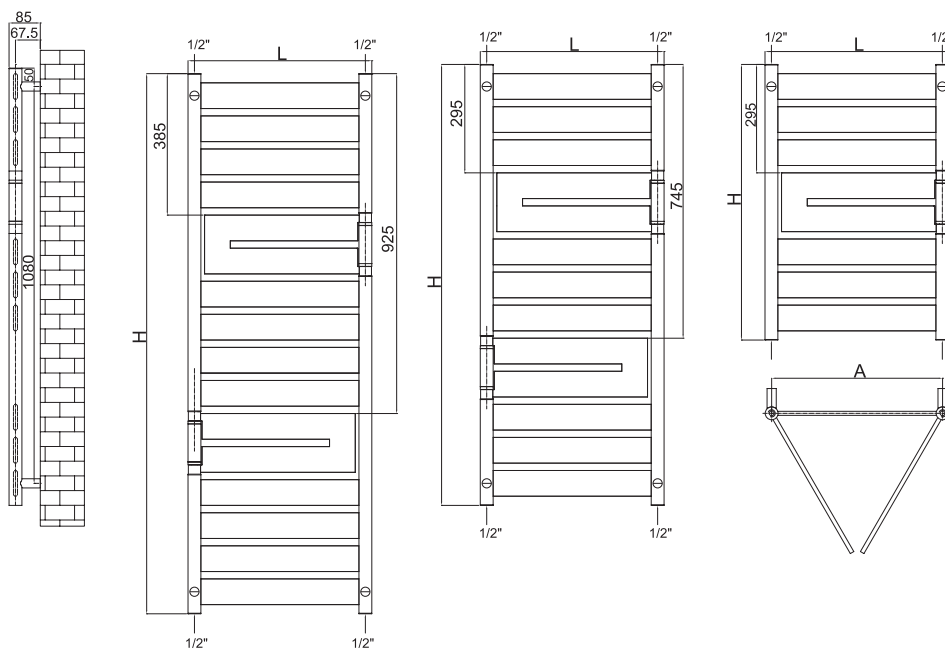

Max. working pressure/  
Presiune max. de lucru  
4 bar



Max. working temperature/  
Temperatură max. de lucru  
90°C



Mounting kit included/  
Kit montaj inclus:  
K02 page 203



Factory pressure test/  
Presiune de probă:  
5.2 bar



Elements/  
Elemente:  
70x11mm



Collectors/  
Colectori:  
Ø35mm

Code/ Cod	Finish / Finisaj	Height/ Înălțime (H)	Length/ Lățime (L)	Centres/ Interax (A)	No el/Nr elemente	Weight/ Greutate	Volume/ Volum	OUTPUT/PUTERE TERMICĂ (watt)			
								Δt=30°C	Δt=50°C	Δt=60°C	electric
		mm	mm	mm	pcs	kg	l	W	W	W	w
APF050/075V9010	RAL 9010 white/alb*	750	500	465	8	10,80	3,90	177	341	426	300
APF050/120V9010		1200	500	465	13	15,70	5,70	287	551	689	600
APF050/147V9010		1470	500	465	16	18,60	6,90	352	677	847	900
APF050/075CR	Chrome / Cromat	750	500	465	8	10,80	3,90	136	262	328	300
APF050/120CR		1200	500	465	13	15,70	5,70	220	424	530	600
APF050/147CR		1470	500	465	16	18,60	6,90	271	521	651	900

● We can make custom dimensions, after technical analysis. | Putem executa dimensiuni speciale, în urma unei analize tehnice.  
The mentioned code is for hydronic version. | Codul menționat este pentru versiunea hidraulică.

Hydraulic connections/  
Conexiuni hidraulice\*\*



S1

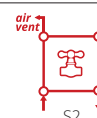

S2

\* For other colours, put your desired RADOX colour code instead of 9010 (standard white). For more details, see page 194  
Pentru alte culori, se pune codul culorii RADOX dorite în locul codului 9010 (standard alb). Mai multe detalii la pag. 194

\*\* When you order, you must mention the type of connection you require. The price changes according to the requirements.  
Când comandați trebuie să menționați tipul de alimentare necesar. Prețul se modifică în funcție de cerințe.



# ARAMIS

Valves are not included and must be ordered separately, if required.  
*Robineții nu sunt incluși și trebuie comandați separat, la cerere.*



# ARAMIS

Creating an unique visual effect, ARAMIS features slim columns connected to thick tubular rows which are open at either ends. Available in stylish colours or stainless steel, ARAMIS can be mounted left or right handed.

Designul unic al radiatorului ARAMIS creează un echilibru între colectorii subțiri și elementii tubulari deschiși la ambele capete. Este disponibil în orice culoare din gama RAL sau oțel inoxidabil și poate fi montat pe partea stângă sau pe partea dreaptă, în funcție de preferințe.

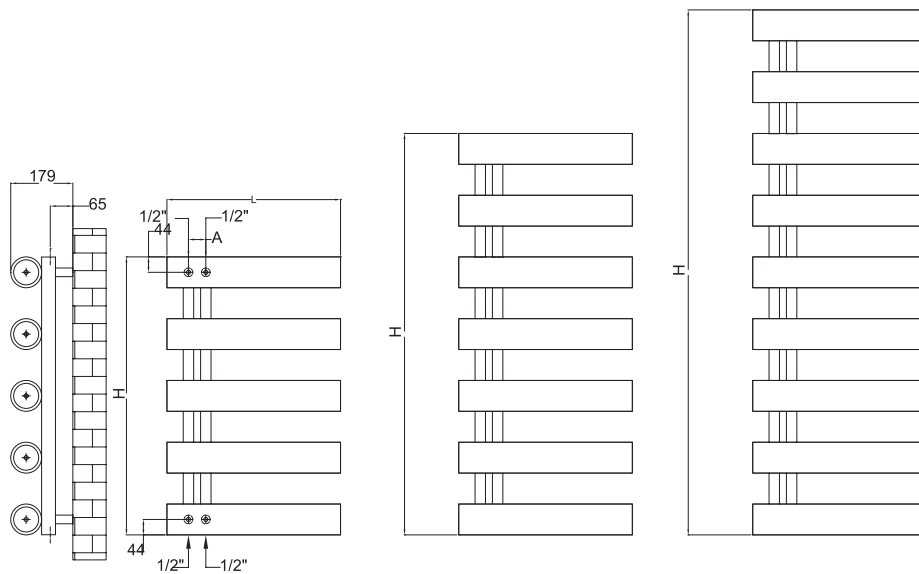

Max. working pressure/  
Presiune max. de lucru  
10 bar



Max. working temperature/  
Temperatură max. de lucru  
90°C



Mounting kit included/  
Kit montaj inclus:  
K03 page 203



Factory pressure test/  
Presiune de probă:  
13 bar



Elements/  
Elemente:  
Ø89mm



Collectors/  
Colectori:  
40x30mm

Code/ Cod	Finish / Finisaj	Height/ Înălțime (H) mm	Length/ Lățime (L) mm	Centres/ Interax (A) mm	No el/Nr elemente pcs	Weight/ Greutate kg	Volume/ Volum l	OUTPUT/PUTERE TERMICĂ (watt)			
								Δt=30°C W	Δt=50°C W	Δt=60°C W	electric w
ARMS050/080V9010	RAL 9010 white/alb*	800	500	50	5	21,30	5,20	411	731	914	900
AR050/115.6V9010		1155	500	50	7	30,00	7,40	578	1027	1284	900
AR050/151.2V9010		1512	500	50	9	38,60	9,50	744	1323	1654	1200
AR050/080XL	Stainless steel/INOX	800	500	50	5	21,30	5,20	304	541	677	900
AR050/115.6X		1155	500	50	7	30,00	7,40	428	761	951	900
AR050/151.2XL		1512	500	50	9	38,60	9,50	551	980	1225	1200

● We can make custom dimensions, after technical analysis. | Putem executa dimensiuni speciale, în urma unei analize tehnice.  
The mentioned code is for hydronic version. | Codul menționat este pentru versiunea hidraulică.

Hydraulic connections/  
Conexiuni hidraulice\*\*



\* For other colours, put your desired RADOX colour code instead of 9010 (standard white). For more details, see page 194  
Pentru alte culori, se pune codul culorii RADOX dorite în locul codului 9010 (standard alb). Mai multe detalii la pag. 194

\*\* When you order, you must mention the type of connection you require. The price changes according to the requirements.  
Când comandați trebuie să menționați tipul de alimentare necesar. Prețul se modifică în funcție de cerințe.



# ARIAL

Valves are not included and must be ordered separately, if required.  
*Robineții nu sunt incluși și trebuie comandați separat, la cerere.*

# ARIAL

Beautifully designed with round tubing, this elegant towel rail would be a striking addition to any bathroom or kitchen alike. Available in RAL colour, chrome plated and stainless steel, ARIAL is an eye-catching product with a minimalistic appeal.

Cu un design frumos și elegant, acest radiator port-prosop produce senzație în orice încăpere, baie sau bucătărie. Disponibil în variantă vopsită, în finisaj cromat și din oțel inoxidabil, ARIAL este un produs atrăgător, cu un aspect minimalist.

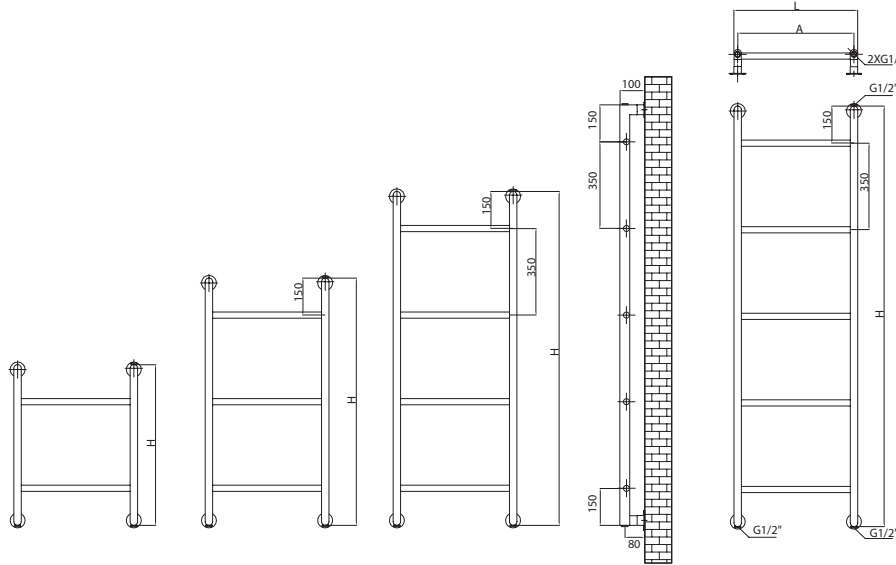

Max. working pressure/  
Presiune max. de lucru  
7 bar



Max. working temperature/  
Temperatură max. de lucru  
90°C



Mounting kit included/  
Kit montaj inclus



Factory pressure test/  
Presiune de probă:  
10 bar



Elements/  
Elemente:  
Ø25mm



Collectors/  
Colectori:  
40x30mm

Code/ Cod	Finish / Finisaj	Height/ Înălțime (H) mm	Length/ Lățime (L) mm	Centres/ Interax (A) mm	No el/Nr elemente pcs	Weight/ Greutate kg	Volume/ Volum l	OUTPUT/PUTERE TERMICĂ (watt)			
								Δt=30°C W	Δt=50°C W	Δt=60°C W	
ARIA050/065V9010	RAL 9010 white/ alb*	650	500	470	2	2,40	1,60	61	117	147	
ARIA060/065V9010		650	600	570	2	2,50	1,60	66	125	157	
ARIA050/100V9010		1000	500	470	3	3,60	2,40	94	179	224	
ARIA060/100V9010		1000	600	570	3	3,80	2,50	100	191	239	
ARIA050/135V9010		1350	500	470	4	4,90	3,20	126	241	301	
ARIA060/135V9010		1350	600	570	4	5,20	3,40	135	257	321	
ARIA050/170V9010		1700	500	470	5	6,20	4,00	159	303	379	
ARIA060/170V9010		1700	600	570	5	6,50	4,30	169	323	403	
ARIA050/065CR		Chrome / Cromat	650	500	470	2	2,40	1,60	47	90	113
ARIA060/065CR			650	600	570	2	2,50	1,60	50	96	120
ARIA050/100CR	1000		500	470	3	3,60	2,40	72	138	172	
ARIA060/100CR	1000		600	570	3	3,80	2,50	77	147	184	
ARIA050/135CR	1350		500	470	4	4,90	3,20	97	185	232	
ARIA060/135CR	1350		600	570	4	5,20	3,40	103	198	247	
ARIA050/170CR	1700		500	470	5	6,20	4,00	122	233	291	
ARIA060/170CR	1700		600	570	5	6,50	4,30	130	248	310	
ARIA050/065X	Stainless steel / INOX		650	500	470	2	2,40	1,60	46	87	109
ARIA060/065X			650	600	570	2	2,50	1,60	49	93	116
ARIA050/100X		1000	500	470	3	3,60	2,40	70	133	166	
ARIA060/100X		1000	600	570	3	3,80	2,50	74	141	177	
ARIA050/135X		1350	500	470	4	4,90	3,20	94	178	223	
ARIA060/135X		1350	600	570	4	5,20	3,40	100	190	238	
ARIA050/170X		1700	500	470	5	6,20	4,00	118	224	280	
ARIA060/170X		1700	600	570	5	6,50	4,30	125	239	299	

● We can make custom dimensions, after technical analysis. | Putem executa dimensiuni speciale, în urma unei analize tehnice.

Hydraulic connections/  
Conexiuni hidraulice\*\*



\* For other colours, put your desired RADOX colour code instead of 9010 (standard white). For more details, see page 194  
Pentru alte culori, se pune codul culorii RADOX dorite în locul codului 9010 (standard alb). Mai multe detalii la pag. 194

\*\* When you order, you must mention the type of connection you require. The price changes according to the requirements.  
Când comandați trebuie să menționați tipul de alimentare necesar. Prețul se modifică în funcție de cerințe.



# AZTEC

Valves are not included and must be ordered separately, if required.  
*Robineții nu sunt incluși și trebuie comandați separat, la cerere.*



# AZTEC

AZTEC with its simple and elegant design, puts a new twist on a classic ladder style towel radiator. A square asymmetric tubular rail with room to warm up plenty of towels, AZTEC is available in RAL colours, chrome and stainless steel.

Disponibil în orice culoare RAL, crom sau inox, AZTEC este un radiator port-prosop care se desprinde de structura clasică tip scară a unui radiator de baie. Organizarea asimetrică a elementelor oferă spațiu generos pentru depozitarea a cât mai multor prosoape.

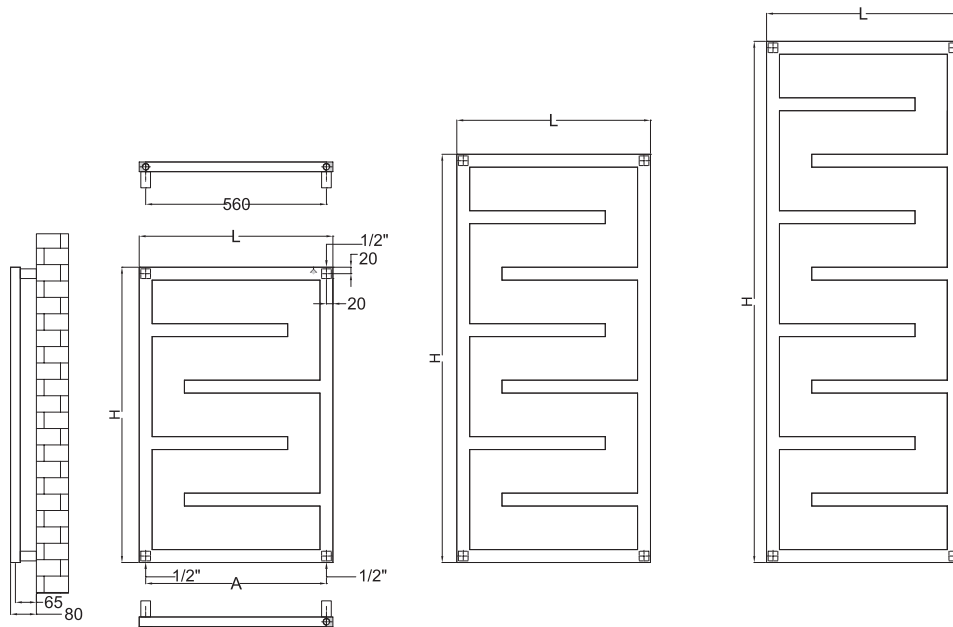

Max. working pressure/  
Presiune max. de lucru  
10 bar



Max. working temperature/  
Temperatură max. de lucru  
90°C



Mounting kit included/  
Kit montaj inclus  
K06 page 203



Factory pressure test/  
Presiune de probă:  
13 bar



Elements/  
Elemente:  
40x30mm



Collectors/  
Colectori:  
40x30mm

Code/ Cod	Finish / Finisaj	Height/ Înălțime (H) mm	Length/ Lățime (L) mm	Centres/ Interax (A) mm	No el/Nr elemente pcs	Weight/ Greutate kg	Volume/ Volum l	OUTPUT/PUTERE TERMICĂ (watt)			
								Δt=30°C W	Δt=50°C W	Δt=60°C W	electric w
SKU060/091.5V9010	RAL 9010 white/alb*	915	600	560	6	7,18	4,55	167	319	398	300
SKU060/126.5V9010		1265	600	560	8	9,61	6,08	223	426	533	500
SKU060/161V9010		1615	600	560	10	12,04	7,62	350	668	835	800
SKU060/091.5CR	Chrome / Cromat	915	600	560	6	7,18	4,55	128	245	306	300
SKU060/126.5CR		1265	600	560	8	9,61	6,08	172	328	410	500
SKU060/161.5CR		1615	600	560	10	12,04	7,62	269	514	642	800
SKU060/091.5XL	Stainless steel /INOX	915	600	560	6	7,18	4,55	124	236	295	300
SKU060/126.5X		1265	600	560	8	9,61	6,08	165	316	395	500
SKU060/161.5X		1615	600	560	10	12,04	7,62	259	495	618	900

● We can make custom dimensions, after technical analysis. | Putem executa dimensiuni speciale, în urma unei analize tehnice.  
The mentioned code is for hydronic version. | Codul menționat este pentru versiunea hidraulică.

Hydraulic connections/  
Conexiuni hidraulice\*\*



S1



S2

\* For other colours, put your desired RADOX colour code instead of 9010 (standard white). For more details, see page 194  
Pentru alte culori, se pune codul culorii RADOX dorite în locul codului 9010 (standard alb). Mai multe detalii la pag. 194

\*\* When you order, you must mention the type of connection you require. The price changes according to the requirements.  
Când comandați trebuie să menționați tipul de alimentare necesar. Prețul se modifică în funcție de cerințe.



# BOKA

Valves are not included and must be ordered separately, if required.  
*Robineții nu sunt incluși și trebuie comandați separat, la cerere.*



# BOKA

BOKA puts a new twist on a classic ladder style towel rail with a simple design that allows for the easy hanging of towels. BOKA is efficient, available in RAL colours or chrome plated, just a perfect addition to any bathroom or kitchen.

*BOKA reprezintă o nouă formă a clasicului radiator port-prosop, cu un design simplu, care permite așezarea ușoară a prosoapelor. Disponibil în varianta vopsită sau cromată, BOKA se adaptează perfect oricărei băi sau bucătării.*

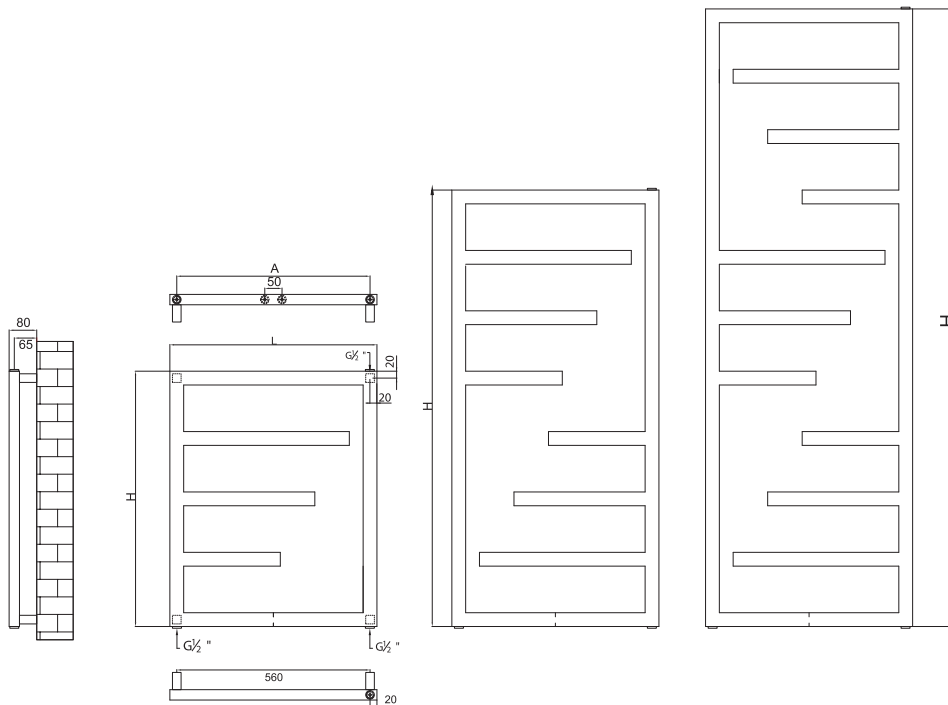

Max. working pressure/  
Presiune max. de lucru  
10 bar



Max. working temperature/  
Temperatură max. de lucru  
90°C



Mounting kit included/  
Kit montaj inclus  
K06 page 203



Factory pressure test/  
Presiune de probă:  
13 bar



Elements/  
Elemente:  
40x30mm



Collectors/  
Colectori:  
40x30mm

Code/ Cod	Finish / Finisaj	Height/ Înălțime (H) mm	Length/ Lățime (L) mm	Centres/ Interax (A) mm	No el/Nr elemente pcs	Weight/ Greutate kg	Volume/ Volum l	OUTPUT/PUTERE TERMICĂ (watt)			
								Δt=30°C W	Δt=50°C W	Δt=60°C W	electric w
BOK060/074V9010	RAL 9010 white/alb*	740	600	560	5	6,40	4,10	133	256	320	300
BOK060/126.5V9010		1265	600	560	8	10,20	6,50	213	409	511	500
BOK060/179V9010		1790	600	560	11	14,10	8,90	292	562	702	600
BOK060/074CR	Chrome/ Cromat	740	600	560	5	6,40	4,10	102	197	246	300
BOK060/126.5CR		1265	600	560	8	10,20	6,50	164	315	393	500
BOK060/179CR		1790	600	560	11	14,10	8,90	225	432	540	600

We can make custom dimensions, after technical analysis. | *Putem executa dimensiuni speciale, în urma unei analize tehnice.*  
The mentioned code is for hydronic version. | *Codul menționat este pentru versiunea hidraulică.*

Hydraulic connections/  
Conexiuni hidraulice\*\*



S1



S2

\* For other colours, put your desired RADOX colour code instead of 9010 (standard white). For more details, see page 194  
*Pentru alte culori, se pune codul culorii RADOX dorite în locul codului 9010 (standard alb). Mai multe detalii la pag. 194*

\*\* When you order, you must mention the type of connection you require. The price changes according to the requirements.  
*Când comandați trebuie să menționați tipul de alimentare necesar. Prețul se modifică în funcție de cerințe.*



# BREAK Q

Valves are not included and must be ordered separately, if required.  
*Robineții nu sunt incluși și trebuie comandați separat, la cerere.*

# BREAK Q

BREAK Q is both stylish and functional with ample room for towels. Contemporary designed, BREAK Q is available in RAL colours and also in special colours such as textured black, white, beige or silver grey.

*BREAK Q este un radiator elegant și funcțional, care dispune de spații generoase pentru depozitarea și încălzirea prosoapelor. Cu un design modern, BREAK Q este disponibil în culorile RAL și de asemenea, în culori speciale, cum ar fi culorile texturate (negru, gri, bej sau alb)*

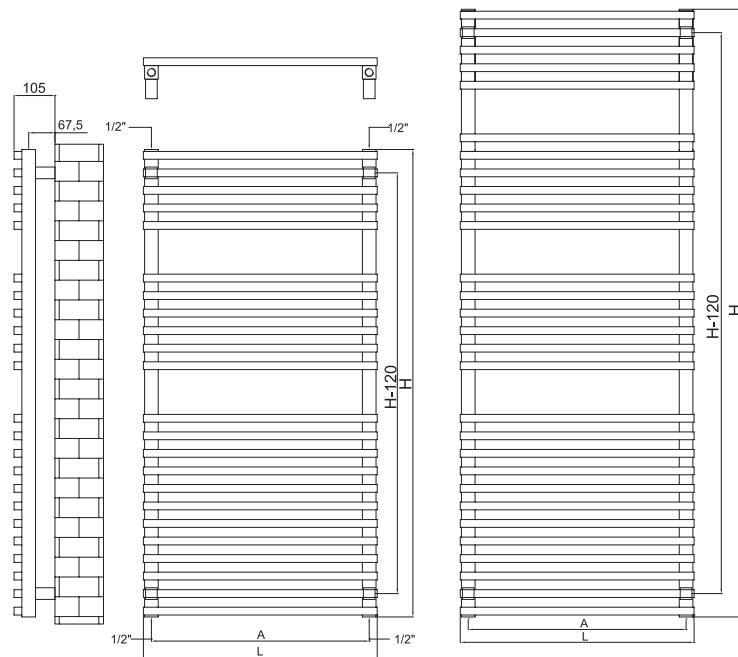

Max. working pressure/  
Presiune max. de lucru  
10 bar



Max. working temperature/  
Temperatură max. de lucru  
90°C



Mounting kit included/  
Kit montaj inclus  
K06 page 203



Factory pressure test/  
Presiune de probă:  
13 bar



Elements/  
Elemente:  
20x20mm



Collectors/  
Colectori:  
35x35mm

Code/ Cod	Finish / Finisaj	Height/ Înălțime (H) mm	Length/ Lățime (L) mm	Centres/ Interax (A) mm	No el/Nr elemente pcs	Weight/ Greutate kg	Volume/ Volum l	OUTPUT/PUTERE TERMICĂ (watt)			
								Δt=30°C W	Δt=50°C W	Δt=60°C W	electric w
BKQ050/120V9010		1200	500	459	23	13,80	5,80	318	607	759	600
BKQ060/120V9010	RAL 9010 white/alb*	1200	600	559	23	15,80	6,40	367	699	874	600
BKQ050/156V9010		1560	500	459	29	17,60	7,40	404	772	965	900
BKQ060/156V9010		1560	600	559	29	20,10	8,20	465	888	1110	900

● We can make custom dimensions, after technical analysis. | Putem executa dimensiuni speciale, în urma unei analize tehnice.  
The mentioned code is for hydronic version. | Codul menționat este pentru versiunea hidraulică.

Hydraulic connections/  
Conexiuni hidraulice\*\*



S1



S2

\* For other colours, put your desired RADOX colour code instead of 9010 (standard white). For more details, see page 194  
Pentru alte culori, se pune codul culorii RADOX dorite în locul codului 9010 (standard alb). Mai multe detalii la pag. 194

\*\* When you order, you must mention the type of connection you require. The price changes according to the requirements.  
Când comandați trebuie să menționați tipul de alimentare necesar. Prețul se modifică în funcție de cerințe.



# DORA 70

Valves are not included and must be ordered separately, if required.  
*Robineții nu sunt incluși și trebuie comandați separat, la cerere.*

# DORA 70

Stretching out asymmetrically to one side, DORA 70 is notably stylish with its slim, rectangular pipes. It can be mounted left or right handed upon your request. Available in all RAL colours and sleek chrome, DORA 70 provides an attractive means to heat bathrooms, kitchens, laundry rooms, foyers and virtually any room where comfort is of prime importance and space is limited.

*DORA 70 completează gama de radiatoare de baie moderne cu un design rectangular și elegant. Poate fi instalat în funcție de preferințe, pe partea stângă sau dreaptă. Este disponibil în orice culoare RAL și crom, ceea ce îl face perfect pentru baie, bucătărie sau, practic, orice cameră în care confortul este o prioritate, dar spațiul este limitat.*

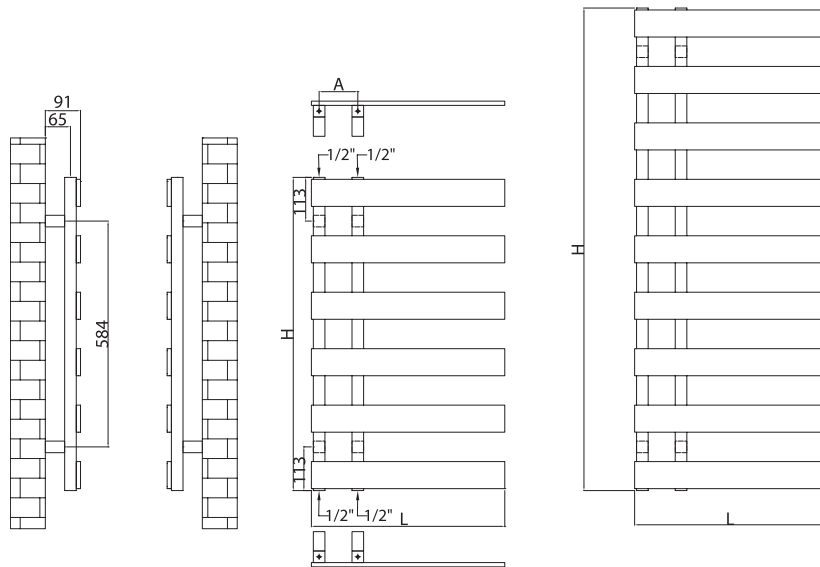

Max. working pressure/  
Presiune max. de lucru  
4 bar



Max. working temperature/  
Temperatură max. de lucru  
90°C



Mounting kit included/  
Kit montaj inclus  
K06 page 203



Factory pressure test/  
Presiune de probă:  
5.2 bar



Elements/  
Elemente:  
70x11mm



Collectors/  
Colectori:  
30x30mm

Code/ Cod	Finish / Finisaj	Height/ Înălțime (H) mm	Length/ Lățime (L) mm	Centres/ Interax (A) mm	No el/Nr elemente pcs	Weight/ Greutate kg	Volume/ Volum l	OUTPUT/PUTERE TERMICĂ (watt)			
								Δt=30°C W	Δt=50°C W	Δt=60°C W	electric w
DOR70050/080V9010	RAL 9010	810	500	100	6	7,51	2,73	167	319	399	300
DOR70050/123.5V9010	white/alb*	1248	500	100	9	11,36	4,15	253	483	603	600
DOR70050/080CR	Chrome / Cromat	810	500	100	6	7,51	2,73	129	245	307	300
DOR70050/123.5CR		1248	500	100	9	11,36	4,15	195	371	464	600

● We can make custom dimensions, after technical analysis. | Putem executa dimensiuni speciale, în urma unei analize tehnice.  
The mentioned code is for hydronic version. | Codul menționat este pentru versiunea hidraulică.

Hydraulic connections/  
Conexiuni hidraulice\*\*



S1



S2

\* For other colours, put your desired RADOX colour code instead of 9010 (standard white). For more details, see page 194  
Pentru alte culori, se pune codul culorii RADOX dorite în locul codului 9010 (standard alb). Mai multe detalii la pag. 194

\*\* When you order, you must mention the type of connection you require. The price changes according to the requirements.  
Când comandați trebuie să menționați tipul de alimentare necesar. Prețul se modifică în funcție de cerințe.



# EMPIRE

Valves are not included and must be ordered separately, if required.  
*Robineții nu sunt incluși și trebuie comandați separat, la cerere.*



# EMPIRE

This traditional English steel towel rail is an ideal option for restoring a period setting or creating an individual style. Floor standing or wall mounted, EMPIRE is all about authentic elegance, distinguished luxury, all available in chrome or RAL colours.

Un radiator din oțel care amintește de stilul tradițional englezesc, EMPIRE devine piesa de rezistență într-un ansamblu de design clasic. EMPIRE poate fi montat pe perete sau pe podea și întrunește toate criteriile de eleganță autentică și rafinament, fiind disponibil cromat sau în orice culoare RAL.

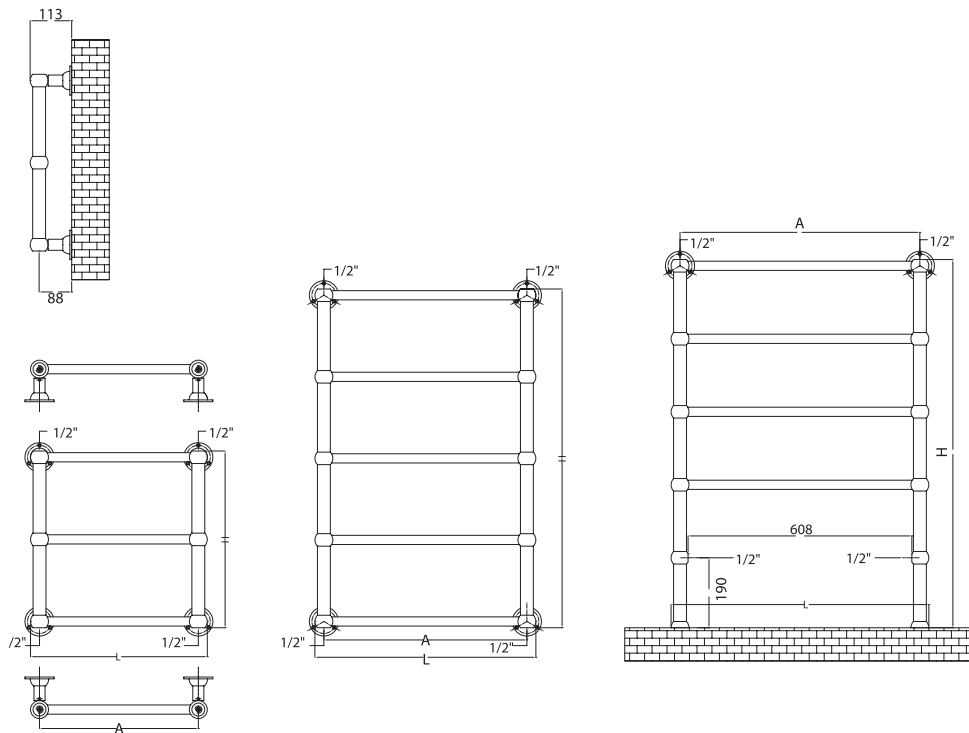

Max. working pressure/ Presiune max. de lucru 10 bar	Max. working temperature/ Temperatură max. de lucru 90°C	Mounting kit included/ Kit montaj inclus K03/07 page 203	Factory pressure test/ Presiune de probă: 13 bar	Elements/ Elemente: Ø25mm	Collectors/ Colectori: Ø35mm						
Code/ Cod	Finish / Finisaj	Height/ Înălțime (H) mm	Length/ Lățime (L) mm	Centres/ Interax (A) mm	No el/Nr elemente pcs	Weight/ Greutate kg	Volume/ Volum l	OUTPUT/PUTERE TERMICĂ (watt)			
								Δt=30°C W	Δt=50°C W	Δt=60°C W	electric w
EM48ORNV9010	RAL 9010 white/alb*	480	480	430	3	2,60	1,20	52	99	124	120
EM60ORNV9010		920	600	550	5	5,10	2,50	106	202	253	300
EM70ORNV9010		1000	700	650	5	5,70	2,80	121	232	289	300
EM48ERNCR	Chrome / Cromat	480	480	430	3	2,60	1,20	40	76	95	120
EM60ORNCR		920	600	550	5	5,10	2,50	82	156	195	300
EM70ORNCR		1000	700	650	5	5,70	2,80	93	178	223	300

We can make custom dimensions, after technical analysis. | Putem executa dimensiuni speciale, în urma unei analize tehnice.  
The mentioned code is for hydronic version. | Codul menționat este pentru versiunea hidraulică.

Hydraulic connections/  
Conexiuni hidraulice\*\*



\* For other colours, put your desired RADOX colour code instead of 9010 (standard white). For more details, see page 194  
Pentru alte culori, se pune codul culorii RADOX dorite în locul codului 9010 (standard alb). Mai multe detalii la pag. 194

\*\* When you order, you must mention the type of connection you require. The price changes according to the requirements.  
Când comandați trebuie să menționați tipul de alimentare necesar. Prețul se modifică în funcție de cerințe.



ESSE

Valves are not included and must be ordered separately, if required.  
*Robineții nu sunt incluși și trebuie comandați separat, la cerere.*

# ESSE

The ultra slim ESSE features flat tubes with a subtle curving profile that flows smoothly, looking perfect in any contemporary setting. With its attractive shape, ESSE can either be used as a supplemental heater or be the sole source of heat for a smaller room.

*Un model ultra suplu cu un profil subțire, ușor curbat care se încadrează perfect în orice schemă de design modern. ESSE poate fi folosit fie ca element suplimentar de încălzire, fie ca sursă unică de căldură pentru un spațiu mai mic.*

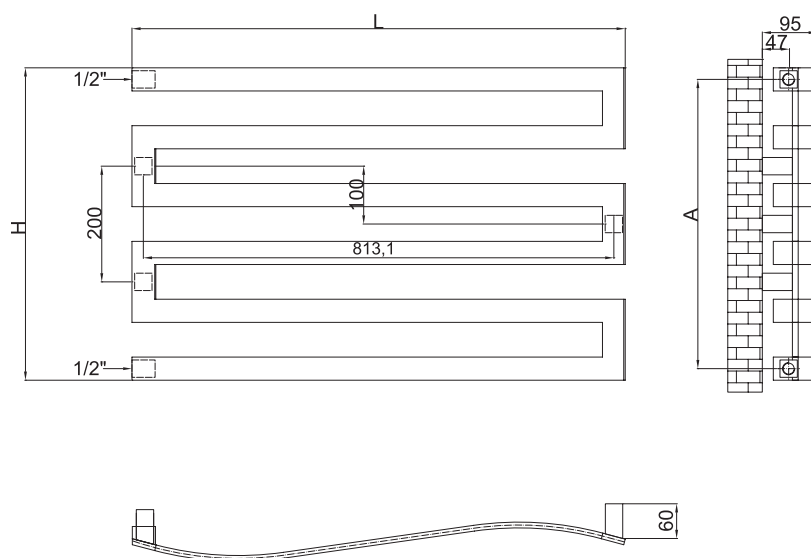

Code/ Cod	Finish / Finisaj	Height/ Înălțime (H)	Length/ Lățime (L)	Centres/ Interax (A)	No el/Nr elementi	Weight/ Greutate	Volume/ Volum	OUTPUT/PUTERE TERMICĂ (watt)		
								Δt=30°C	Δt=50°C	Δt=60°C
ES054/085V9010	RAL 9010 white/alb*	540	850	500	6	6,00	1,40	142	271	339
ES054/085CR	Chrome / Cromat	540	850	500	6	6,00	1,40	109	208	261

● We can make custom dimensions, after technical analysis. | Putem executa dimensiuni speciale, în urma unei analize tehnice.

Hydraulic connections/  
Conexiuni hidraulice\*\*



S1

\* For other colours, put your desired RADOX colour code instead of 9010 (standard white). For more details, see page 194  
Pentru alte culori, se pune codul culorii RADOX dorite în locul codului 9010 (standard alb). Mai multe detalii la pag. 194

\*\* When you order, you must mention the type of connection you require. The price changes according to the requirements.  
Când comandați trebuie să menționați tipul de alimentare necesar. Prețul se modifică în funcție de cerințe.



# KAZAR L

Valves are not included and must be ordered separately, if required.  
*Robineții nu sunt incluși și trebuie comandați separat, la cerere.*

# KAZAR L

KAZAR L is a wonderful addition to any room, bathroom or kitchen. It is a solid, practical and attractive radiator that will heat your room and provide you the luxury of a warm fluffy towel to wrap yourself in. Available in all finishes, KAZAR L is an unique pieces, especially in a beautiful brushed stainless steel, the finish being applied by hand by highly skilled metalworkers meaning yours will be 100% unique.

*KAZAR L va aduce acel plus de stil și eleganță de care este nevoie în orice cameră, baie sau bucătărie. Radiator solid, practic și atractiv, încălzește în mod eficient atât camera, cât și prosoapele pentru un confort sporit. Disponibil în toate finisajele, KAZAR L este unic, în special în versiunea satinată de oțel inoxidabil, fiind realizat manual de către profesioniști pentru a asigura acestui radiator o calitate și un aspect excepțional.*

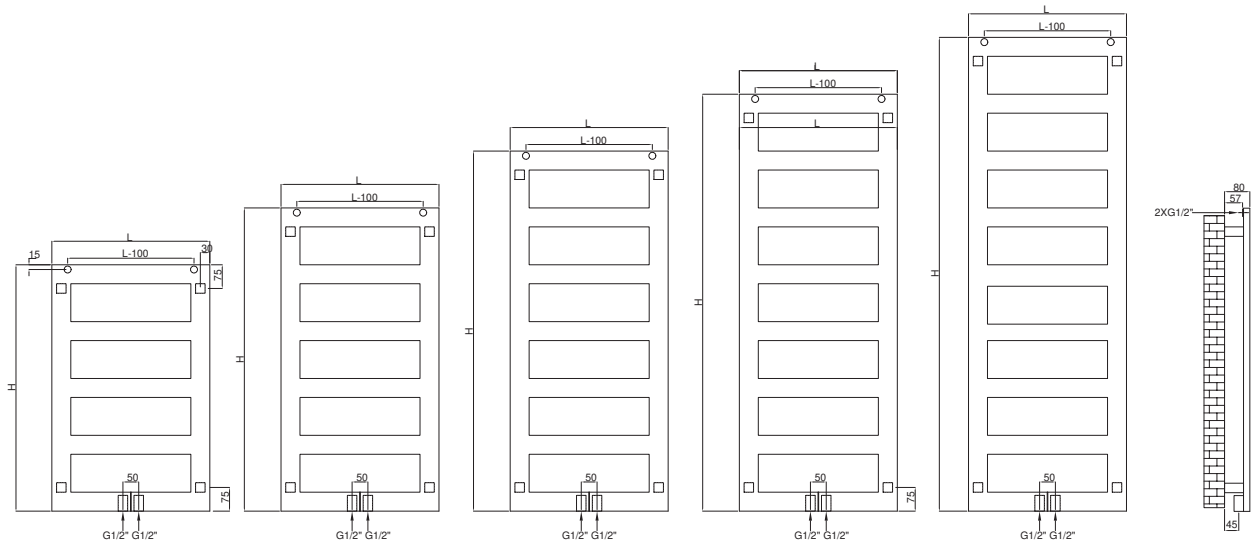

Max. working pressure/  
Presiune max. de lucru 6 bar



Max. working temperature/  
Temperatură max. de lucru 90°C



Mounting kit included/  
Kit montaj inclus K06 page 203



Factory pressure test/  
Presiune de probă: 8 bar



Elements/Elemenți:  
60x20mm

Code/ Cod	Finish / Finisaj	Height/ Înălțime (H) mm	Length/ Lățime (L) mm	Centres/ Interax (A) mm	No el/Nr elementi pcs	Weight/ Greutate kg	Volume/ Volum l	OUTPUT/PUTERE TERMICĂ (watt)		
								Δt=30°C	Δt=50°C	Δt=60°C
KAZL050/078V9010	RAL 9010 white/ alb*	780	500	50	5	7,40	2,80	127	242	302
KAZL060/078V9010		780	600	50	5	8,30	3,10	143	274	342
KAZL050/096V9010		960	500	50	6	9,10	3,40	157	300	375
KAZL060/096V9010		960	600	50	6	10,30	3,90	178	340	425
KAZL050/114V9010		1140	500	50	7	10,90	4,10	187	358	447
KAZL060/114V9010		1140	600	50	7	12,30	4,60	213	406	507
KAZL050/132V9010		1320	500	50	8	12,60	4,70	218	416	520
KAZL060/132V9010		1320	600	50	8	14,30	5,40	247	472	590
KAZL050/150V9010		1500	500	50	9	14,40	5,40	248	474	592
KAZL060/150V9010		1500	600	50	9	16,30	6,10	282	538	672
KAZL050/078CR	Chrome / Cromat	780	500	50	5	7,40	2,80	97	186	232
KAZL060/078CR		780	600	50	5	8,30	3,10	110	210	263
KAZL050/096CR		960	500	50	6	9,10	3,40	121	230	288
KAZL060/096CR		960	600	50	6	10,30	3,90	137	261	327
KAZL050/114CR		1140	500	50	7	10,90	4,10	144	275	344
KAZL060/114CR		1140	600	50	7	12,30	4,60	163	312	390
KAZL050/132CR		1320	500	50	8	12,60	4,70	168	320	400
KAZL060/132CR		1320	500	50	8	14,30	5,40	190	363	453
KAZL050/150CR		1500	500	50	9	14,40	5,40	191	364	455
KAZL060/150CR		1500	600	50	9	16,30	6,10	217	414	517
KAZL050/078XL	Stainless steel / INOX	780	500	50	5	7,40	2,80	94	179	224
KAZL060/078XL		780	600	50	5	8,30	3,10	106	203	253
KAZL050/096XL		960	500	50	6	9,10	3,40	116	222	277
KAZL060/096XL		960	600	50	6	10,30	3,90	132	252	314
KAZL050/114XL		1140	500	50	7	10,90	4,10	139	265	331
KAZL060/114XL		1140	600	50	7	12,30	4,60	157	300	376
KAZL050/132XL		1320	500	50	8	12,60	4,70	161	308	385
KAZL060/132XL		1320	600	50	8	14,30	5,40	183	349	437
KAZL050/150XL		1500	500	50	9	14,40	5,40	184	351	439
KAZL060/150XL		1500	600	50	9	16,30	6,10	209	398	498

● We can make custom dimensions, after technical analysis. | Putem executa dimensiuni speciale, în urma unei analize tehnice.

Hydraulic connections/  
Conexiuni hidraulice\*\*



\* For other colours, put your desired RADOX colour code instead of 9010 (standard white). For more details, see page 194  
Pentru alte culori, se pune codul culorii RADOX dorite în locul codului 9010 (standard alb). Mai multe detalii la pag. 194

\*\* When you order, you must mention the type of connection you require. The price changes according to the requirements.  
Când comandați trebuie să menționați tipul de alimentare necesar. Prețul se modifică în funcție de cerințe.



LINX

Valves are not included and must be ordered separately, if required.  
*Robineții nu sunt incluși și trebuie comandați separat, la cerere.*



# LINX

Fully reversible for left or right situations, LINX has a sleek, balanced design with its tubular elements arranged perpendicular to the vertical manifolds. LINX is an elegant towel warmer with tubes evenly spaced, designed for optimal positioning of towels. Available in all RAL colours or chrome.

Complet reversibil pentru montaj pe partea stângă sau pe partea dreaptă, LINX are un design elegant, echilibrat, cu elementii săi dispuși perpendicular pe colectori verticali. LINX este radiator deosebit, cu un design echilibrat al elementelor dispuși în mod egal, pentru o poziționare și încălzire optimă a prosoapelor. Disponibil în culori RAL sau crom.

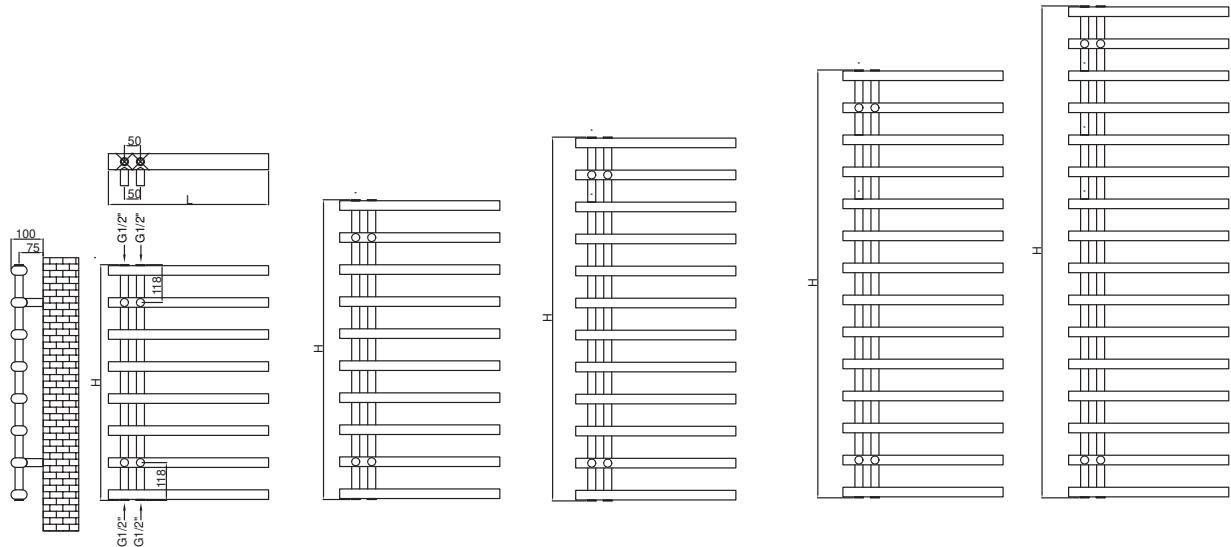

- Max. working pressure/ Presiune max. de lucru 10 bar
- Max. working temperature/ Temperatură max. de lucru 90°C
- Mounting kit included/ Kit montaj inclus K02 page 203
- Factory pressure test/ Presiune de probă: 13 bar
- Elements/ Elemente: 50x30mm
- Collectors/ Colectori: Ø25mm

Code/ Cod	Finish / Finisaj	Height/ Înălțime (H)	Length/ Lățime (L)	Centres/ Interax (A)	No el/Nr elementi	Weight/ Greutate	Volume/ Volum	OUTPUT/PUTERE TERMICĂ (watt)			
								Δt=30°C	Δt=50°C	Δt=60°C	electric
AMV050/075V9010	RAL 9010 white/ alb*	736	500	50	8	7,40	4,80	156	298	372	300
AMV050/095V9010		936	500	50	10	9,30	6,00	196	373	466	500
AMV050/115V9010		1136	500	50	12	11,10	7,20	235	449	561	600
AMV050/135V9010		1336	500	50	14	13,00	8,50	275	524	655	600
AMV050/155V9010		1536	500	50	16	14,90	9,70	314	600	750	600
AM050/075CR	Chrome / Cromat	736	500	50	8	7,40	4,80	120	229	286	300
AM050/095CR		936	500	50	10	9,30	6,00	150	287	359	500
AMV050/115CR		1136	500	50	12	11,10	7,20	181	345	431	600
AM050/135CR		1336	500	50	14	13,00	8,50	211	403	504	600
AMV050/155CR		1536	500	50	16	14,90	9,70	242	461	577	600
MIXT AM050/075V9010/CR	Ral9010* + Chrome	736	500	50	8	7,40	4,80	120	229	286	300
AM050/095V9010/CR		936	500	50	10	9,30	6,00	150	287	359	500
AM050/115V9010/CR		1136	500	50	12	11,10	7,20	181	345	431	600
AM050/135V9010/CR		1336	500	50	14	13,00	8,50	211	403	504	600
AM050/155V9010/CR		1536	500	50	16	14,90	9,70	242	461	577	600

● We can make custom dimensions, after technical analysis. | Putem executa dimensiuni speciale, în urma unei analize tehnice. The mentioned code is for hydronic version. | Codul menționat este pentru versiunea hidraulică.

Hydraulic connections/  
Conexiuni hidraulice\*\*



\* For other colours, put your desired RADOX colour code instead of 9010 (standard white). For more details, see page 194  
Pentru alte culori, se pune codul culorii RADOX dorite în locul codului 9010 (standard alb). Mai multe detalii la pag. 194

\*\* When you order, you must mention the type of connection you require. The price changes according to the requirements.  
Când comandați trebuie să menționați tipul de alimentare necesar. Prețul se modifică în funcție de cerințe.



# PREMIER XL

Valves are not included and must be ordered separately, if required.  
*Robineții nu sunt incluși și trebuie comandați separat, la cerere.*



# PREMIER XL

PREMIER XL provides you the highest quality towel rails around. Your Stainless Steel Towel Radiator will last and last, and keep on warming your room and towels for years to come. The small width range allows them to fit into small spaces while providing the warmth you need. PREMIER XL is also available in ROUND version.

Realizat din oțel inoxidabil, PREMIER XL oferă garanția unui produs de calitate superioară. Este unul dintre produsele cele mai apreciate și vândute datorită caracteristicilor tehnice, puterii termice ridicate și eleganței formei sale. Gama de lățimi mici permite încadrarea sa în spații înguste, putând asigura confortul termic dorit. PREMIER XL este disponibil și în varianta ROUND.

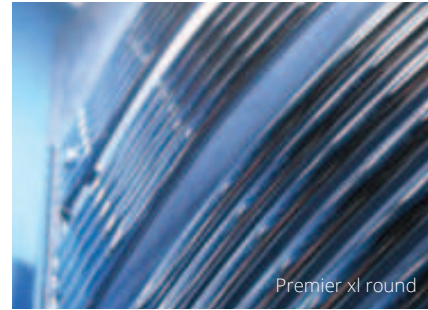

Premier xl round

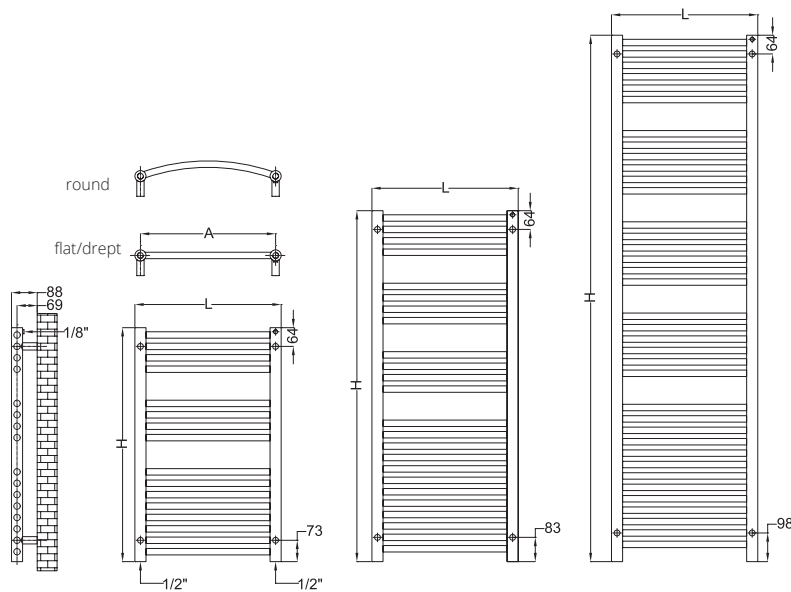

Code/ Cod	Finish / Finisaj	Height/ Înălțime (H)	Length/ Lățime (L)	Centres/ Interax (A)	No el/Nr elementi	Weight/ Greutate	Volume/ Volum	OUTPUT/PUTERE TERMICĂ (watt)		
								Δt=30°C	Δt=50°C	Δt=60°C
PREMB045/080XKE	Stainless steel / INOX	800	450	412	16	5,70	3,20	121	231	289
PREMB050/080XKE		800	500	462	16	6,10	3,50	132	253	316
PREMB060/080XKE		800	600	562	16	6,90	3,90	155	296	370
PREMB045/120XKE		1200	450	412	24	8,40	4,90	181	346	433
PREMB050/120XKE		1200	500	462	24	9,00	5,20	198	379	473
PREMB060/120XKE		1200	600	562	24	10,30	5,90	232	443	554
PREMB045/180XKE		1800	450	412	37	12,70	7,40	277	529	661
PREMB050/180XKE		1800	500	462	37	13,70	7,90	303	578	723
PREMB060/180XKE		1800	600	562	37	15,60	9,00	355	678	847

● We can make custom dimensions, after technical analysis. | Putem executa dimensiuni speciale, în urma unei analize tehnice.

Hydraulic connections/  
Conexiuni hidraulice\*\*



\* For other colours, put your desired RADOX colour code instead of 9010 (standard white). For more details, see page 194  
Pentru alte culori, se pune codul culorii RADOX dorite în locul codului 9010 (standard alb). Mai multe detalii la pag. 194

\*\* When you order, you must mention the type of connection you require. The price changes according to the requirements.  
Când comandați trebuie să menționați tipul de alimentare necesar. Prețul se modifică în funcție de cerințe.



# QUEBIS

Valves are not included and must be ordered separately, if required.  
*Robineții nu sunt incluși și trebuie comandați separat, la cerere.*

# QUEBIS

Straightforward radiator, QUEBIS does its job wonderfully. Its steel square tubes create a very attractive towel rail. This elegant, yet practical towel rail heats the room whilst supporting towels with ease. QUEBIS is available also in ROUND version.

QUEBIS este un radiator care oferă ceea ce promite: design clasic, calitate și putere termică mare. Acest radiator elegant, dar practic, va încălzi orice încăpere, în timp ce încălzește prosoapele ușor și eficient. QUEBIS este disponibil și în varianta ROUND.

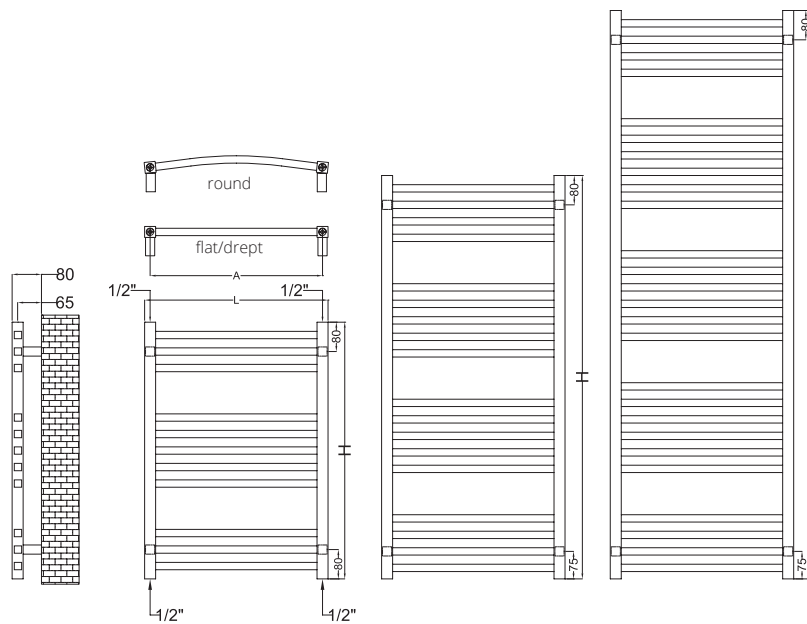

Max. working pressure/  
Presiune max. de lucru  
7 bar



Max. working temperature/  
Temperatură max. de lucru  
90°C



Mounting kit included/  
Kit montaj inclus  
K06/26 page 203



Factory pressure test/  
Presiune de probă:  
10bar



Elements/  
Elemente:  
20x20mm



Collectors/  
Colectori:  
30x30mm

Code/ Cod	Finish / Finisaj	Height/ Înălțime (H) mm	Length/ Lățime (L) mm	Centres/ Interax (A) mm	No el/Nr elemente pcs	Weight/ Greutate kg	Volume/ Volum l	OUTPUT/PUTERE TERMICĂ (watt)			
								Δt=30°C W	Δt=50°C W	Δt=60°C W	electric W
QE050/070V9010KE	RAL 9010	700	500	470	11	6,10	2,40	151	289	361	300
QE050/110V9010KE	white/ alb*	1100	500	470	18	9,90	3,90	244	466	582	500
QE050/155V9010KE		1550	500	470	26	14,10	5,60	349	667	833	600
QE050/070CKE	Chrome / Cromat	700	500	470	11	6,10	2,40	116	222	278	300
QE050/110CKE		1100	500	470	18	9,90	3,90	188	358	448	500
QE050/155CKE		1550	500	470	26	14,10	5,60	269	513	641	600

● We can make custom dimensions, after technical analysis. | Putem executa dimensiuni speciale, în urma unei analize tehnice.  
The mentioned code is for flat and hydronic version. | Codul menționat este doar pentru versiunea dreaptă și hidraulică.

Hydraulic connections/  
Conexiuni hidraulice\*\*



S1



S2

\* For other colours, put your desired RADOX colour code instead of 9010 (standard white). For more details, see page 194  
Pentru alte culori, se pune codul culorii RADOX dorite în locul codului 9010 (standard alb). Mai multe detalii la pag. 194

\*\* When you order, you must mention the type of connection you require. The price changes according to the requirements.  
Când comandați trebuie să menționați tipul de alimentare necesar. Prețul se modifică în funcție de cerințe.



# RICO

Valves are not included and must be ordered separately, if required.  
*Robineții nu sunt incluși și trebuie comandați separat, la cerere.*



# RICO

Elegant yet highly functional, RICO is a design towel rail that will hold and warm several towels with ease and efficiency. Perfect for every type of bathroom whether traditional or contemporary, RICO is available in all RAL colours.

*Elegant, însă foarte practică, RICO este un radiator port-prosoape de design care poate încălzi mai multe prosoape cu ușurință și eficiență. Perfect pentru orice tip de baie, fie tradițională sau contemporană, RICO este disponibil în toate culorile RAL.*

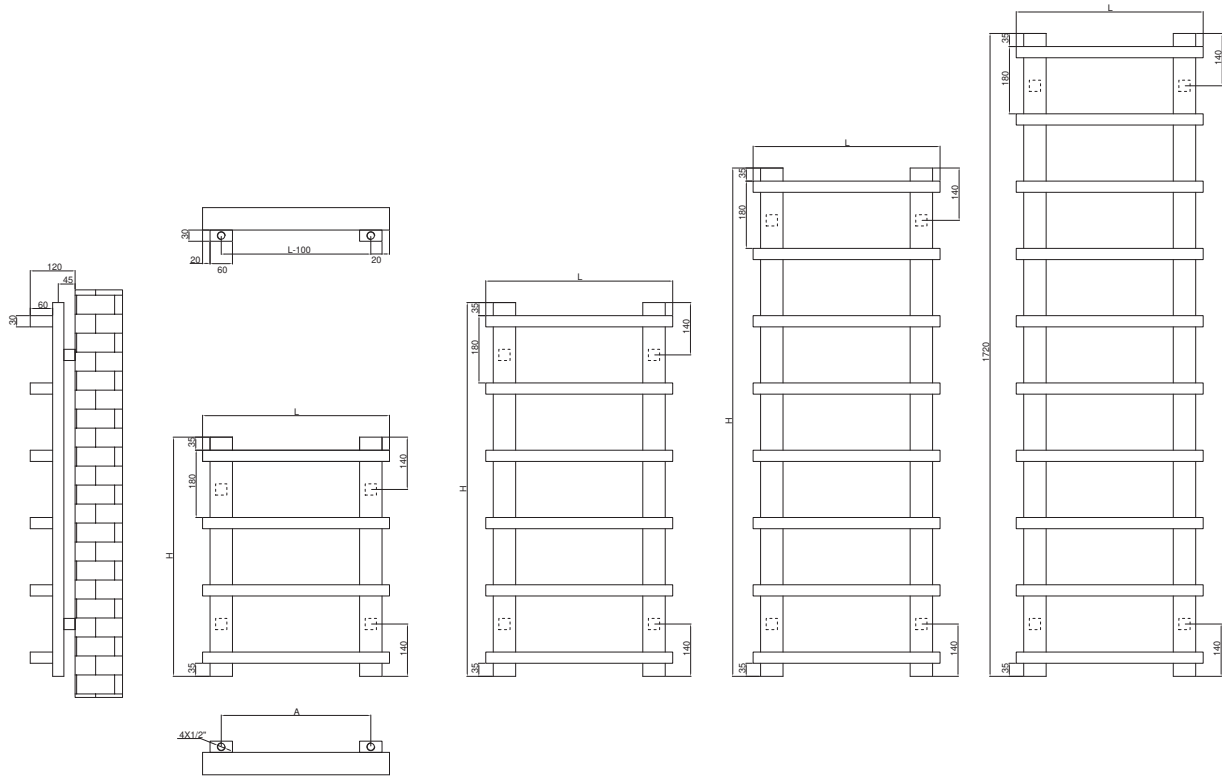

Max. working pressure/  
Presiune max. de lucru  
10 bar



Max. working temperature/  
Temperatură max. de lucru  
90°C



Mounting kit included/  
Kit montaj inclus  
K06 page 203



Factory pressure test/  
Presiune de probă:  
13 bar



Elements/  
Elemente:  
60x30mm



Collectors/  
Colectori:  
60x30mm

Code/ Cod	Finish / Finisaj	Height/ Înălțime (H) mm	Length/ Lățime (L) mm	Centres/ Interax (A) mm	No el/Nr elemente pcs	Weight/ Greutate kg	Volume/ Volum l	OUTPUT/PUTERE TERMICĂ (watt)		
								Δt=30°C W	Δt=50°C W	Δt=60°C W
RICO050/064V9010	RAL 9010 white/ alb*	640	500	400	4	6,70	5,10	140	269	336
RICO060/064V9010		640	600	500	4	7,50	5,70	157	301	377
RICO050/100V9010		1000	500	400	6	10,30	7,70	212	408	510
RICO060/100V9010		1000	600	500	6	11,50	8,60	238	457	571
RICO050/136V9010		1360	500	400	8	13,80	10,30	285	548	684
RICO060/136V9010		1360	600	500	8	15,40	11,60	318	612	765
RICO050/172V9010		1720	500	400	10	17,30	13,00	357	687	859
RICO060/172V9010		1720	600	500	10	19,40	14,50	399	768	960

● We can make custom dimensions, after technical analysis. | Putem executa dimensiuni speciale, în urma unei analize tehnice.

Hydraulic connections/  
Conexiuni hidraulice\*\*



S1



S2

\* For other colours, put your desired RADOX colour code instead of 9010 (standard white). For more details, see page 194  
Pentru alte culori, se pune codul culorii RADOX dorite în locul codului 9010 (standard alb). Mai multe detalii la pag. 194

\*\* When you order, you must mention the type of connection you require. The price changes according to the requirements.  
Când comandați trebuie să menționați tipul de alimentare necesar. Prețul se modifică în funcție de cerințe.



# RIVER

Valves are not included and must be ordered separately, if required.  
*Robineții nu sunt incluși și trebuie comandați separat, la cerere.*



# RIVER

Contemporary-style towel rail, RIVER complements any bathroom or kitchen alike. It is conveniently available in all finishes adding value to any design scheme.

Un radiator port-prosop contemporan, RIVER completează orice baie sau bucătărie. Disponibil în toate finisajele (cromat, vopsit, inox), RIVER adaugă stil și eleganță oricărui interior.

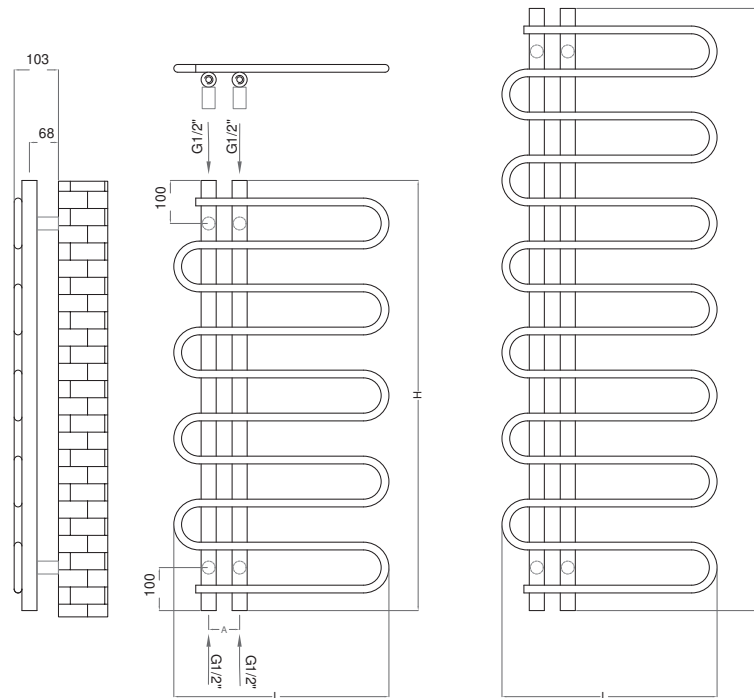

Max. working pressure/  
Presiune max. de lucru  
7 bar



Max. working temperature/  
Temperatură max. de lucru  
90°C



Mounting kit included/  
Kit montaj inclus  
K03/12 page 203



Factory pressure test/  
Presiune de probă:  
10 bar



Elements/  
Elemente:  
Ø18mm



Collectors/  
Colectori:  
Ø35mm

Code/ Cod	Finish / Finisaj	Height/ Înălțime (H) mm	Length/ Lățime (L) mm	Centres/ Interax (A) mm	No el./Nr elemente pcs	Weight/ Greutate kg	Volume/ Volum l	OUTPUT/PUTERE TERMICĂ (watt)			
								Δt=30°C W	Δt=50°C W	Δt=60°C W	electric W
SK050/100V9010	RAL 9010	1000	500	72	9	4,80	2,70	137	261	326	300
SK065/140V9010	white/alb*	1400	650	72	13	7,50	4,20	231	441	551	500
SK050/100CR	Chrome / Cromat	1000	500	72	9	4,80	2,70	105	201	251	300
SK065/140CR		1400	650	72	13	7,50	4,20	178	339	424	500
SK050/100X	Stainless	1000	500	72	9	4,80	2,70	101	193	241	300
SK065/140X	steel /INOX	1400	650	72	13	7,50	4,20	171	327	408	500

● We can make custom dimensions, after technical analysis. | Putem executa dimensiuni speciale, în urma unei analize tehnice.  
The mentioned code is for hydronic version. | Codul menționat este pentru versiunea hidraulică.

Hydraulic connections/  
Conexiuni hidraulice\*\*

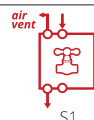

\* For other colours, put your desired RADOX colour code instead of 9010 (standard white). For more details, see page 194  
Pentru alte culori, se pune codul culorii RADOX dorite în locul codului 9010 (standard alb). Mai multe detalii la pag. 194

\*\* When you order, you must mention the type of connection you require. The price changes according to the requirements.  
Când comandați trebuie să menționați tipul de alimentare necesar. Prețul se modifică în funcție de cerințe.



# SERA

Valves are not included and must be ordered separately, if required.  
*Robineții nu sunt incluși și trebuie comandați separat, la cerere.*





# SERA

Modern styled towel rail with its contemporary look and feel, SERA is sure to compliment any modern room. Available in all finishes and also in electric version, SERA can suit any bathroom or kitchen, bringing that designer feel into your home.

*Cu designul său modern, SERA completează perfect orice cameră. Disponibil în toate finisajele, SERA este perfect pentru orice bucătărie sau baie, adăugând un plus de stil în orice locuință.*

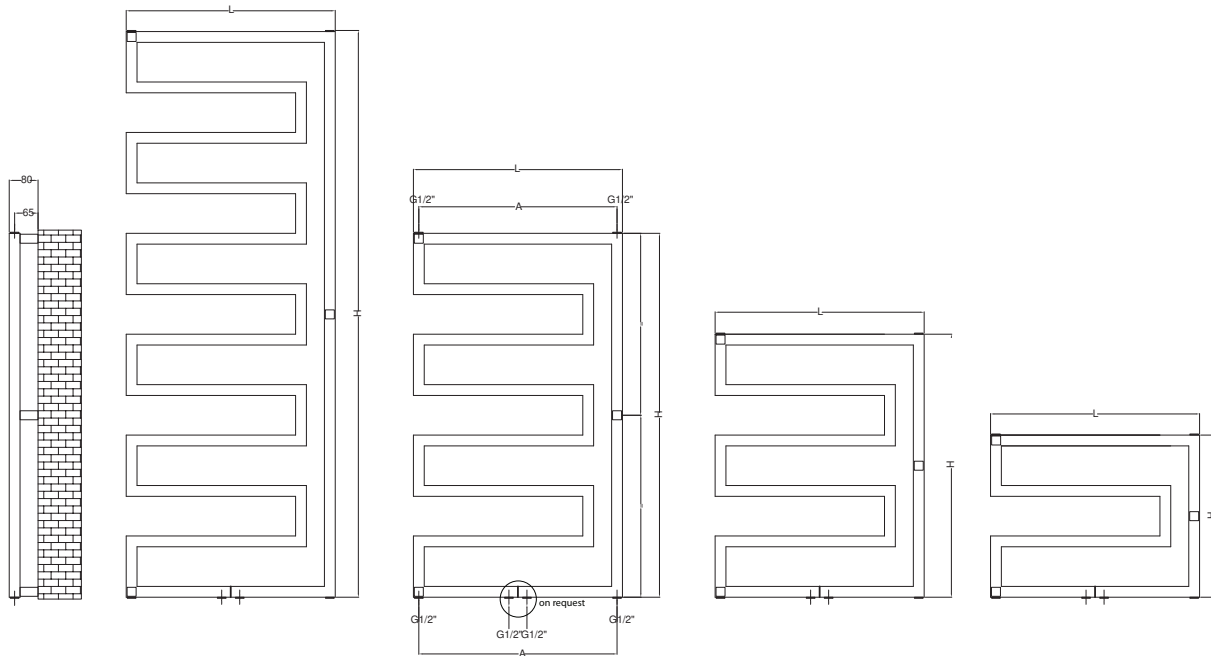
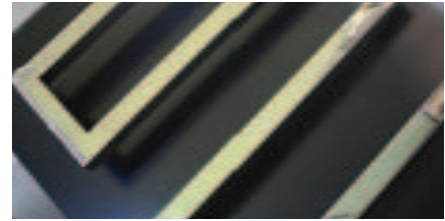

Max. working pressure/  
Presiune max. de lucru  
10 bar



Max. working temperature/  
Temperatură max. de lucru  
90°C



Mounting kit included/  
Kit montaj inclus  
K24 page 203



Factory pressure test/  
Presiune de probă:  
13bar



Elements/  
Elemente:  
30x30mm



Collectors/  
Colectori:  
30x30mm

Code/ Cod	Finish / Finisaj	Height/ Înălțime (H) mm	Length/ Lățime (L) mm	Centres/ Interax (A) mm	No el/Nr elemente pcs	Weight/ Greu- tate kg	Volume/ Volum l	OUTPUT/PUTERE TERMICĂ (watt)			
								Δt=30°C	Δt=50°C	Δt=60°C	electric
SERA058/045V9010	RAL 9010 white/ alb*	450	580	550	4	3,87	2,10	95	181	227	120
SERA058/073V9010		730	580	550	6	5,88	3,19	145	276	345	300
SERA058/101V9010		1010	580	550	8	7,89	4,29	194	370	463	300
SERA058/157V9010		1570	580	550	12	11,90	6,50	293	559	699	600
SERA058/045CR	Chrome / Cromat	450	580	550	4	3,87	2,10	73	140	174	120
SERA058/073CR		730	580	550	6	5,88	3,19	111	212	265	300
SERA058/101CR		1010	580	550	8	7,89	4,29	149	285	356	300
SERA058/157CR		1570	580	550	12	11,90	6,50	225	430	538	600
SERA058/045X	Stainless steel / INOX	450	580	550	4	3,87	2,10	70	134	168	120
SERA058/073X		730	580	550	6	5,88	3,19	107	204	256	300
SERA058/101X		1010	580	550	8	7,89	4,29	144	274	343	300
SERA058/157XL		1570	580	550	12	11,90	6,50	217	414	518	600

⚙️ We can make custom dimensions, after technical analysis. | Putem executa dimensiuni speciale, în urma unei analize tehnice.  
The mentioned code is for hydronic version. | Codul menționat este pentru versiunea hidrolică.

Hydraulic connections/  
Conexiuni hidrolice\*\*



\* For other colours, put your desired RADOX colour code instead of 9010 (standard white). For more details, see page 194  
Pentru alte culori, se pune codul culorii RADOX dorite în locul codului 9010 (standard alb). Mai multe detalii la pag. 194

\*\* When you order, you must mention the type of connection you require. The price changes according to the requirements.  
Când comandați trebuie să menționați tipul de alimentare necesar. Prețul se modifică în funcție de cerințe.



# SERENE

Valves are not included and must be ordered separately, if required.  
*Robineții nu sunt incluși și trebuie comandați separat, la cerere.*



# SERENE

SERENE is a contemporary radiator, just perfect for warming multiple towels at once and distributing heat in any modern bathroom, kitchen or laundry room. Available in chrom, Ral colours and stainless steel.

SERENE este un radiator contemporan, perfect pentru încălzirea mai multor prosoape și pentru a asigura confortul termic în orice baie modernă, bucătărie sau altă încăpere. Disponibil în finisaj cromat, vopsit RAL și inox.

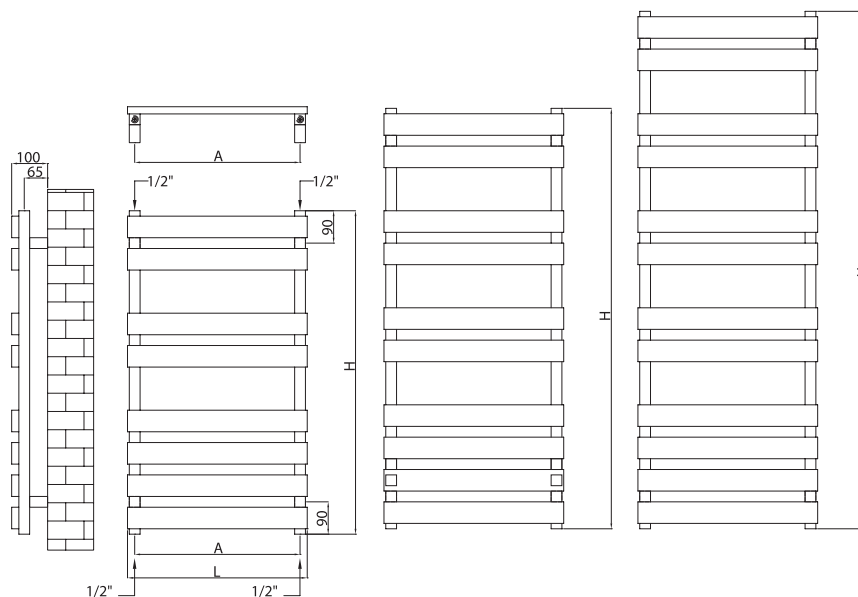

Max. working pressure/  
Presiune max. de lucru  
5 bar



Max. working temperature/  
Temperatură max. de lucru  
90°C



Mounting kit included/  
Kit montaj inclus  
K06 page 203



Factory pressure test/  
Presiune de probă:  
6.5 bar



Elements/  
Elemente:  
60x20mm



Collectors/  
Colectori:  
30x30mm

Code/ Cod	Finish / Finisaj	Height/ Înălțime (H) mm	Length/ Lățime (L) mm	Centres/ Interax (A) mm	No el/Nr elemente pcs	Weight/ Greutate kg	Volume/ Volum l	OUTPUT/PUTERE TERMICĂ (watt)			
								Δt=30°C W	Δt=50°C W	Δt=60°C W	electric*** W
KU050/090V9010	RAL 9010	900	500	460	8	12,00	4,90	222	424	529	500
KU1170/500V9010	white/ alb*	1170	500	460	10	15,00	6,20	280	534	668	500
SER050/144V9010		1440	500	460	12	18,00	7,50	338	645	807	600
SER050/090CR	Chrome / Cromat	900	500	460	8	12,00	4,90	171	326	407	500
SER050/117CR		1170	500	460	10	15,00	6,20	215	411	514	500
SER050/144CR		1440	500	460	12	18,00	7,50	260	496	621	600
SER050/090X	Stainless steel / INOX	900	500	460	8	12,00	4,90	164	314	392	500
SER050/117X		1170	500	460	10	15,00	6,20	207	396	495	500
SER050/144X		1440	500	460	12	18,00	7,50	250	478	598	600

● We can make custom dimensions, after technical analysis. | Putem executa dimensiuni speciale, în urma unei analize tehnice.  
The mentioned code is for hydronic version. | Codul menționat este pentru versiunea hidraulică.

Hydraulic connections/  
Conexiuni hidraulice\*\*



S1



S2

\* For other colours, put your desired RADOX colour code instead of 9010 (standard white). For more details, see page 194  
Pentru alte culori, se pune codul culorii RADOX dorite în locul codului 9010 (standard alb). Mai multe detalii la pag. 194

\*\* When you order, you must mention the type of connection you require. The price changes according to the requirements.  
Când comandați trebuie să menționați tipul de alimentare necesar. Prețul se modifică în funcție de cerințe.



# SERPENTINE

Valves are not included and must be ordered separately, if required.  
*Robineții nu sunt incluși și trebuie comandați separat, la cerere.*

# SERPENTINE

SERPENTINE is an unique, simple and elegant radiator. No longer just a heating object, SERPENTINE is an item of furniture for every home. As usual, our customers can personalize the sizes and finishes, beautiful RAL colours, chrome plated or stainless steel.

*SERPENTINE este un radiator unic, simplu și elegant. Acest radiator depășește limitele unui element de încălzire și devine o adevărată piesă de mobilier. Ca de obicei, clienții noștri pot personaliza dimensiunile și alege finisajul: culori RAL, crom sau inox.*

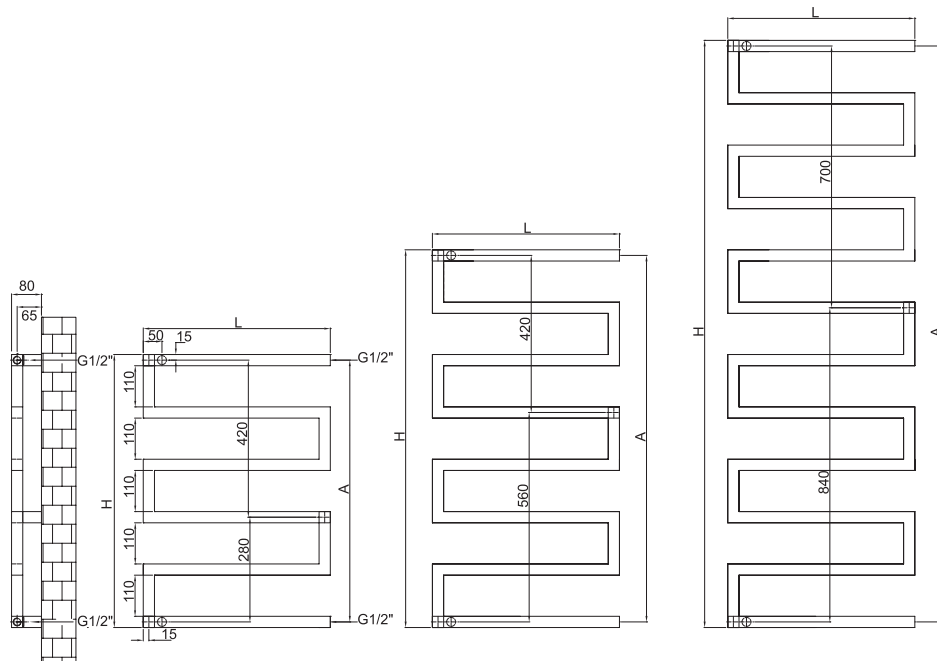
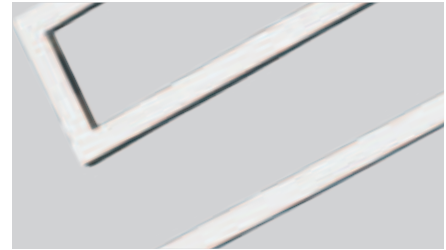

Max. working pressure/  
Presiune max. de lucru 10 bar



Max. working temperature/  
Temperatură max. de lucru 90°C



Mounting kit included/  
Kit montaj inclus K24 page 203



Factory pressure test/  
Presiune de probă: 13bar



Elements/Elemenți:  
30x30mm

Code/ Cod	Finish / Finisaj	Height/ Înălțime (H) mm	Length/ Lățime (L) mm	Centres/ Interax (A) mm	No el/Nr elementi pcs	Weight/ Greutate kg	Volume/ Volum l	OUTPUT/PUTERE TERMICĂ (watt)		
								Δt=30°C W	Δt=50°C W	Δt=60°C W
SERUK050/073V9010	RAL 9010	730	500	700	6	4,60	2,50	116	221	275
SERUK050/101RAL9010	white/ alb*	1010	500	980	8	6,20	3,30	155	297	370
SERUK050/157RAL9010		1570	500	1540	12	9,30	5,00	235	449	559
SERUK050/073CR	Chrome / Cromat	730	500	700	6	4,60	2,50	89	170	212
SERUK050/101CR		1010	500	980	8	6,20	3,30	120	228	285
SERUK050/157CR		1570	500	1540	12	9,30	5,00	181	345	430
SERUK050/073XL	Stainless steel / INOX	730	500	700	6	4,60	2,50	86	164	204
SERUK050/101XL		1010	500	980	8	6,20	3,30	115	220	274
SERUK050/157XL		1570	500	1540	12	9,30	5,00	174	332	414

● We can make custom dimensions, after technical analysis. | Putem executa dimensiuni speciale, în urma unei analize tehnice.

Hydraulic connections/  
Conexiuni hidraulice\*\*



S1



S2

\* For other colours, put your desired RADOX colour code instead of 9010 (standard white). For more details, see page 194  
Pentru alte culori, se pune codul culorii RADOX dorite în locul codului 9010 (standard alb). Mai multe detalii la pag. 194

\*\* When you order, you must mention the type of connection you require. The price changes according to the requirements.  
Când comandați trebuie să menționați tipul de alimentare necesar. Prețul se modifică în funcție de cerințe.



# SMART U

Valves are not included and must be ordered separately, if required.  
*Robineții nu sunt incluși și trebuie comandați separat, la cerere.*



# SMART U

SMARTU U has a very functional shape to hang or store towels upon its shelf, so you can keep your towels warm and snug on, while not taking up too much space itself.

SMART U are un design funcțional ce permite agățarea sau depozitarea prosoapelor pe raftul său. Astfel, veți păstra prosoapele calde, în timp ce economisiți spațiu.



SMART U nipped/niplat ( for chrome plated/ pentru cromat)

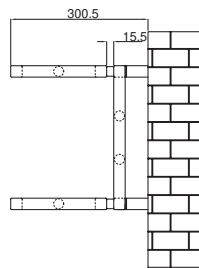

SMART U welded/sudat (for RAL / pentru vopsit)

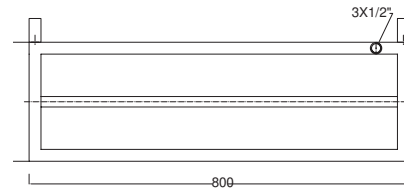
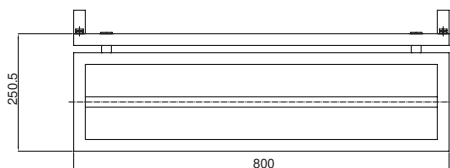
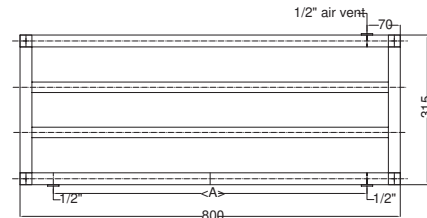
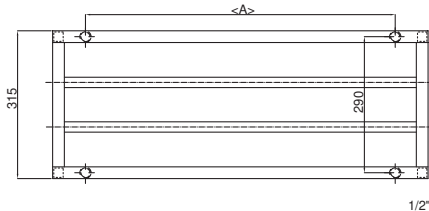
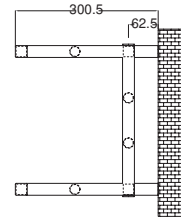

Max. working pressure/  
Presiune max. de lucru  
10 bar



Max. working temperature/  
Temperatură max. de lucru  
90°C



Mounting kit included/  
Kit montaj inclus  
K06 page 203



Factory pressure test/  
Presiune de probă:  
13bar



Elements/  
Elemente:  
Ø22mm



Collectors/  
Colectori:  
25x25mm

Code/ Cod	Finish / Finisaj	Height/ Înălțime (H) mm	Length/ Lățime (L) mm	Centres/ Interax (A) mm	No el/Nr elemente pcs	Weight/ Greutate kg	Volume/ Volum l	OUTPUT/PUTERE TERMICĂ (watt)		
								Δt=30°C W	Δt=50°C W	Δt=60°C W
SMU080/031.5V9010	RAL 9010 white/alb*	315	800	660	4	8,50	3,70	230	439	526
SMU080/031.5CR	Chrome / Cromat	315	800	660	4	8,50	3,70	177	338	405

● We can make custom dimensions, after technical analysis. | Putem executa dimensiuni speciale, în urma unei analize tehnice.

Hydraulic connections/  
Conexiuni hidraulice\*\*

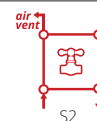

\* For other colours, put your desired RADOX colour code instead of 9010 (standard white). For more details, see page 194  
Pentru alte culori, se pune codul culorii RADOX dorite în locul codului 9010 (standard alb). Mai multe detalii la pag. 194

\*\* When you order, you must mention the type of connection you require. The price changes according to the requirements.  
Când comandați trebuie să menționați tipul de alimentare necesar. Prețul se modifică în funcție de cerințe.



# SUNNY FLEXI

Valves are not included and must be ordered separately, if required.  
*Robineții nu sunt incluși și trebuie comandați separat, la cerere.*







# SUNNY FLEXI

With its innovative design, SUNNY FLEXI is just perfect for heating your room and your towels & clothes efficiently and in style. SUNNY FLEXI, all rounded, looks simple but it has been carefully designed for maximum performance and heating, offering the benefits of the hot water that runs through all the towel bars, including the flexible element. Its biggest advantage is that drying the towel will not slow down the convection of the movement of air through the radiator for heating the room.

*Cu un design inovator, SUNNY FLEXI este perfect pentru încălzirea camerei, a prosoapelor și a hainelor în mod eficient și cu stil. SUNNY FLEXI, cu forma lui rotundă, pare simplu, dar a fost atent proiectat pentru performanțe maxime de încălzire, oferind beneficiile apei calde care circulă prin toți elementii săi, inclusiv prin elementul flexibil. Dar, marele lui avantaj este că uscarea prosopului nu va încetini convecția căldurii generate de radiator în mediul ambiant.*

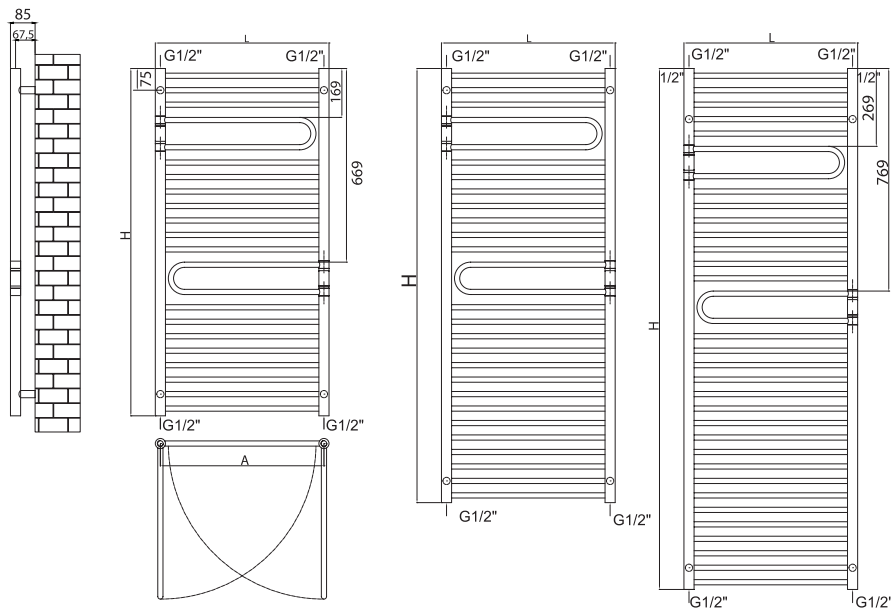

Max. working pressure/  
Presiune max. de lucru  
10 bar



Max. working temperature/  
Temperatură max. de lucru  
90°C



Mounting kit included/  
Kit montaj inclus  
K02 page 203



Factory pressure test/  
Presiune de probă:  
13 bar



Elements/  
Elemente:  
Ø18mm



Collectors/  
Colectori:  
Ø35mm

Code/ Cod	Finish / Finisaj	Height/ Înălțime (H)	Length/ Lățime (L)	Centres/ Interax (A)	No el/Nr elemente	Weight/ Greutate	Volume/ Volum	OUTPUT/PUTERE TERMICĂ (watt)			
								Δt=30°C	Δt=50°C	Δt=60°C	electric
		mm	mm	mm	pcs	kg	l	W	W	W	W
SUF060/120V9010	RAL 9010	1200	600	565	22	7,90	4,30	275	528	660	500
SUF060/150V9010	white/ alb*	1500	600	565	28	9,90	5,40	338	650	812	600
SUF060/180V9010		1800	600	565	34	12,00	6,50	401	771	963	600
SUF060/120CR	Chrome / Cromat	1200	600	565	22	7,90	4,30	211	406	508	500
SUF060/150CR		1500	600	565	28	9,90	5,40	260	500	625	600
SUF060/180CR		1800	600	565	34	12,00	6,50	308	593	741	600

● We can make custom dimensions, after technical analysis. | Putem executa dimensiuni speciale, în urma unei analize tehnice.  
The mentioned code is for hydronic version. | Codul menționat este pentru versiunea hidraulică.

Hydraulic connections/  
Conexiuni hidraulice\*\*



\* For other colours, put your desired RADOX colour code instead of 9010 (standard white). For more details, see page 194  
Pentru alte culori, se pune codul culorii RADOX dorite în locul codului 9010 (standard alb). Mai multe detalii la pag. 194

\*\* When you order, you must mention the type of connection you require. The price changes according to the requirements.  
Când comandați trebuie să menționați tipul de alimentare necesar. Prețul se modifică în funcție de cerințe.



# UPPER

Valves are not included and must be ordered separately, if required.  
*Robineții nu sunt incluși și trebuie comandați separat, la cerere.*



# UPPER

With its design, UPPER represents style in its simplest straight form. Its slim squared tubes leave a large space in-between, giving a minimalistic appearance to this radiator and allowing ample room for several towels. UPPER is available in sleek chrome finish, and also in stainless steel and RAL colours.

UPPER reprezintă eleganță și stil prin simplitatea formelor drepte. Designul minimalist cu elemente rectangulare și subțiri oferă suficient spațiu pentru depozitarea și încălzirea prosoapelor. UPPER este disponibil în finisaj crom, oțel inoxidabil și în culori RAL.

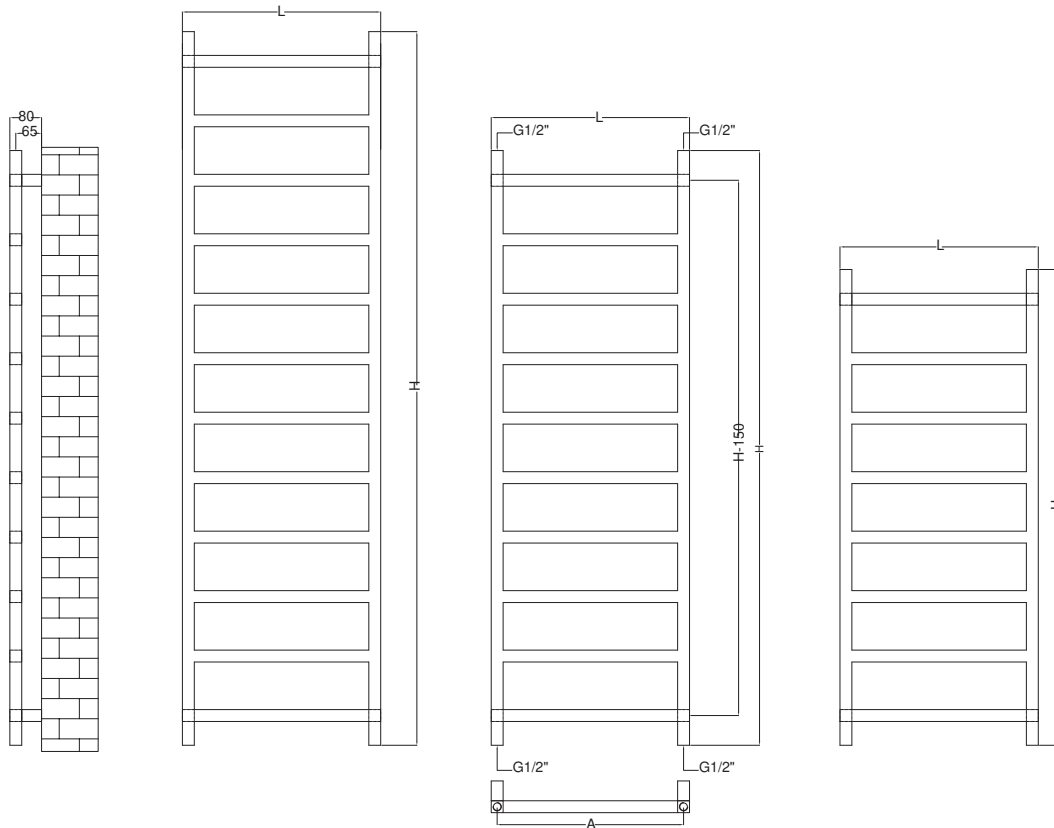

Max. working pressure/  
Presiune max. de lucru 10 bar



Max. working temperature/  
Temperatură max. de lucru 90°C



Mounting kit included/  
Kit montaj inclus K06 page 203



Factory pressure test/  
Presiune de probă: 13 bar



Elements&collectors/  
Elemente și colectori: 30x30mm

Code/ Cod	Finish / Finisaj	Height/ Înălțime (H) mm	Length/ Lățime (L) mm	Centres/ Interax (A) mm	No el/Nr elemente pcs	Weight/ Greutate kg	Volume/ Volum l	OUTPUT/PUTERE TERMICĂ (watt)			
								Δt=30°C W	Δt=50°C W	Δt=60°C W	electric W
UP050/120V9010KE	RAL 9010 white/ alb*	1200	500	470	8	5,50	2,90	184	352	440	300
UP050/150V9010KE		1500	500	470	10	6,90	3,60	230	440	550	500
UP050/180V9010		1800	500	470	12	8,30	4,40	276	527	659	600
UP050/120CR	Chrome / Cromat	1200	500	470	8	5,50	2,90	142	271	338	300
UP050/150CR		1500	500	470	10	6,90	3,60	177	338	423	500
UP050/180CR		1800	500	470	12	8,30	4,40	213	406	507	600
UP050/120XLKE	Stainless steel / INOX	1200	500	470	8	5,50	2,90	137	261	326	300
UP050/150XLKE		1500	500	470	10	6,90	3,60	171	326	407	500
UP050/180X		1800	500	470	12	8,30	4,40	205	391	488	600

● We can make custom dimensions, after technical analysis. | Putem executa dimensiuni speciale, în urma unei analize tehnice.  
The mentioned code is for hydronic version. | Codul menționat este pentru versiunea hidraulică.

Hydraulic connections/  
Conexiuni hidraulice\*\*



\* For other colours, put your desired RADOX colour code instead of 9010 (standard white). For more details, see page 194  
Pentru alte culori, se pune codul culorii RADOX dorite în locul codului 9010 (standard alb). Mai multe detalii la pag. 194

\*\* When you order, you must mention the type of connection you require. The price changes according to the requirements.  
Când comandați trebuie să menționați tipul de alimentare necesar. Prețul se modifică în funcție de cerințe.



# UPPER QUADRO

Valves are not included and must be ordered separately, if required.  
*Robineții nu sunt incluși și trebuie comandați separat, la cerere.*



# UPPER QUADRO

No longer a simple ladder rail design, UPPER QUADRO pushing the boundaries of what can be done with metal, heat and water to create stunning radiator designs. With a square elegant robehook, UPPER QUADRO is just perfect for both kitchens and bathrooms.

UPPER QUADRO demonstrează că nu există limitări în ceea ce privește designul unui radiator. Un adevărat element estetic, practic și robust, UPPER QUADRO devine piesa de rezistență în bucătărie sau baie, putând fi accesoriat cu un agățător elegant și util (robehook).

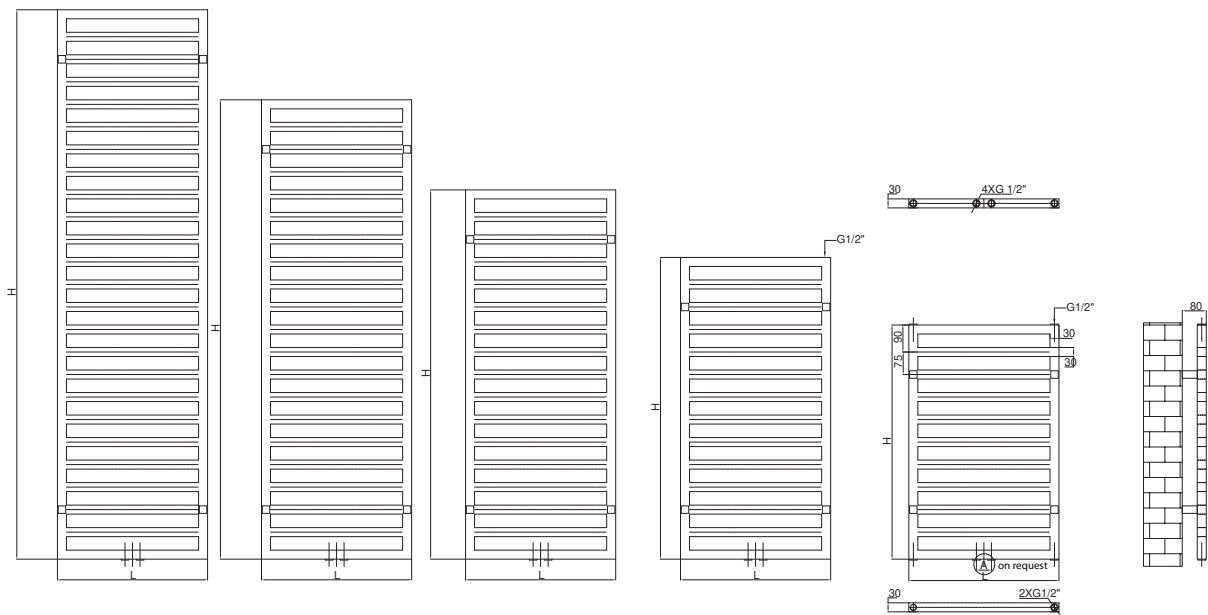

Max. working pressure/  
Presiune max. de lucru 10 bar



Max. working temperature/  
Temperatură max. de lucru 90°C



Mounting kit included/  
Kit montaj inclus K06 page 203



Factory pressure test/  
Presiune de probă: 13 bar



Elements&collectors/  
Elemente&colectori: 30x30mm

Code/ Cod	Finish / Finisaj	Height/ Înălțime (H) mm	Length/ Lățime (L) mm	Centres/ Interax (A) mm	No el/Nr elementi pcs	Weight/ Greu- tate kg	Volume/ Volum l	OUTPUT/PUTERE TERMICĂ (watt)			
								Δt=30°C W	Δt=50°C W	Δt=60°C W	electric W
UPQ050/078V9010	RAL 9010 white/ alb*	780	500	470	11	8,59	4,70	206	393	491	500
UPQ050/100V9010		1005	500	470	14	10,90	6,00	263	502	628	600
UPQ050/123V9010		1230	500	470	17	13,30	7,30	320	611	764	600
UPQ050/153V9010		1530	500	470	21	16,50	9,00	396	756	745	900
UPQ050/183V9010		1830	500	470	25	19,70	10,70	472	900	1125	900
UPQ050/078CR	Chrome / Cromat	780	500	470	11	8,59	4,70	158	302	378	500
UPQ050/100CR		1005	500	470	14	10,90	6,00	202	386	483	600
UPQ050/123CR		1230	500	470	17	13,30	7,30	246	470	588	600
UPQ050/153CR		1530	500	470	21	16,50	9,00	305	582	727	900
UPQ050/183CR		1830	500	470	25	19,70	10,70	363	692	865	900

● We can make custom dimensions, after technical analysis. | Putem executa dimensiuni speciale, în urma unei analize tehnice.  
The mentioned code is for hydronic version. | Codul menționat este pentru versiunea hidraulică.

Hydraulic connections/  
Conexiuni hidraulice\*\*



S1



S2

\* For other colours, put your desired RADOX colour code instead of 9010 (standard white). For more details, see page 194  
Pentru alte culori, se pune codul culorii RADOX dorite în locul codului 9010 (standard alb). Mai multe detalii la pag. 194

\*\* When you order, you must mention the type of connection you require. The price changes according to the requirements.  
Când comandați trebuie să menționați tipul de alimentare necesar. Prețul se modifică în funcție de cerințe.



# VULCAN NV

Valves are not included and must be ordered separately, if required.  
*Robineții nu sunt incluși și trebuie comandați separat, la cerere.*

# VULCAN NV

VULCAN NV can suit any bathroom or kitchen with its sequential gaps, designating spaces for more towels and larger towels too. An architectural work of heating art, VULCAN NV becomes a feature of the room, transforming from just a source of heat, into a focal point of design in the room. Available in RAL colours and chrome.

*VULCAN NV este un adevărat element arhitectural care oferă personalitate oricărei camere. Un radiator practic și elegant, VULCAN NV este potrivit atât în baie, cât și în bucătărie: încălzește eficient camera și permite depozitarea și încălzirea eficientă a prosoapelor. Disponibil în finisaj crom sau vopsit în culori RAL.*

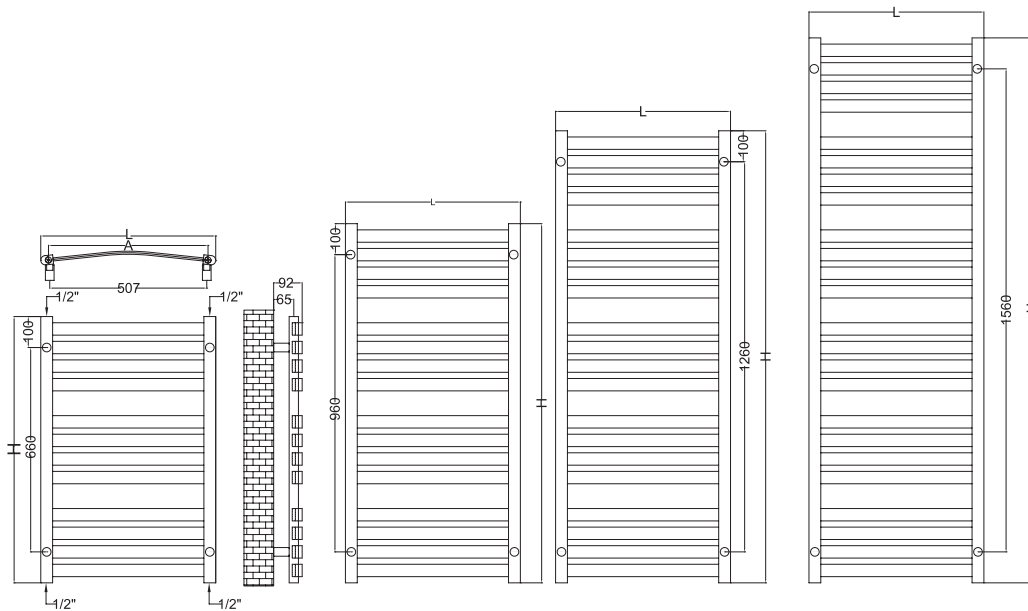

Max. working pressure/  
Presiune max. de lucru  
7 bar



Max. working temperature/  
Temperatură max. de lucru  
90°C



Mounting kit included/  
Kit montaj inclus  
K03 page 203



Factory pressure test/  
Presiune de probă:  
10bar



Elements/  
Elemente:  
40x10mm



Collectors/  
Colectori:  
40x30mm

Code/ Cod	Finish / Finisaj	Height/ Înălțime (H) mm	Length/ Lățime (L) mm	Centres/ Interax (A) mm	No el/Nr elemente pcs	Weight/ Greu- tate kg	Volume/ Volum l	OUTPUT/PUTERE TERMICĂ (watt)			
								Δt=30°C	Δt=50°C	Δt=60°C	electric
VUNV056.5/086V9010	RAL 9010 white/ alb*	860	565	515	12	8,90	3,10	220	420	524	500
VUNV056.5/116V9010		1160	565	515	16	12,00	4,20	294	560	700	600
VUNV056.5/146V9010		1460	565	515	20	15,00	5,20	367	701	877	600
VUNV56.5/176V9010		1760	565	515	24	18,00	6,30	441	842	1053	900
VUNV056.5/086CR	Chrome / Cromat	860	565	515	12	8,90	3,10	169	323	403	500
VUNV056.5/116CR		1160	565	515	16	12,00	4,20	226	431	539	600
VUNV056.5/146CR		1460	565	515	20	15,00	5,20	283	539	674	600
VUNV056.5/176CR		1760	565	515	24	18,00	6,30	339	648	810	900

● We can make custom dimensions, after technical analysis. | Putem executa dimensiuni speciale, în urma unei analize tehnice.  
The mentioned code is for hydronic version. | Codul menționat este pentru versiunea hidraulică.

Hydraulic connections/  
Conexiuni hidraulice\*\*



S1



S2

\* For other colours, put your desired RADOX colour code instead of 9010 (standard white). For more details, see page 194  
Pentru alte culori, se pune codul culorii RADOX dorite în locul codului 9010 (standard alb). Mai multe detalii la pag. 194

\*\* When you order, you must mention the type of connection you require. The price changes according to the requirements.  
Când comandați trebuie să menționați tipul de alimentare necesar. Prețul se modifică în funcție de cerințe.



# VULCAN NV FLEXI

Valves are not included and must be ordered separately, if required.  
*Robineții nu sunt incluși și trebuie comandați separat, la cerere.*





# VULCAN NV FLEXI

VULCAN NV FLEXI with its sequential gaps, generates warmth and homogeneous heating in any room. Our flexible heated towel rail, VULCAN NV FLEXI, offers the benefits of the hot water runs through all the towel bars, including the flexible element that also enables easy hanging and removal of any items due to its space efficient design. Its biggest advantage is that drying the towel will not slow down the convection of the movement of air through the radiator for heating the room.

*VULCAN NV FLEXI cu distribuția sa secvențială a elementelor, încălzește uniform orice încăpere. VULCAN NV FLEXI oferă beneficiile apei calde care circulă prin toți elementii săi, inclusiv prin elementul flexibil, care permite punerea și îndepărtarea ușoară a diverselor articole textile, datorită design-ului eficient al spațiului. Dar, marea lui avantaj este că uscarea prosopului nu va încetini niciodată convecția caldurii generate de radiator în mediul ambiant.*

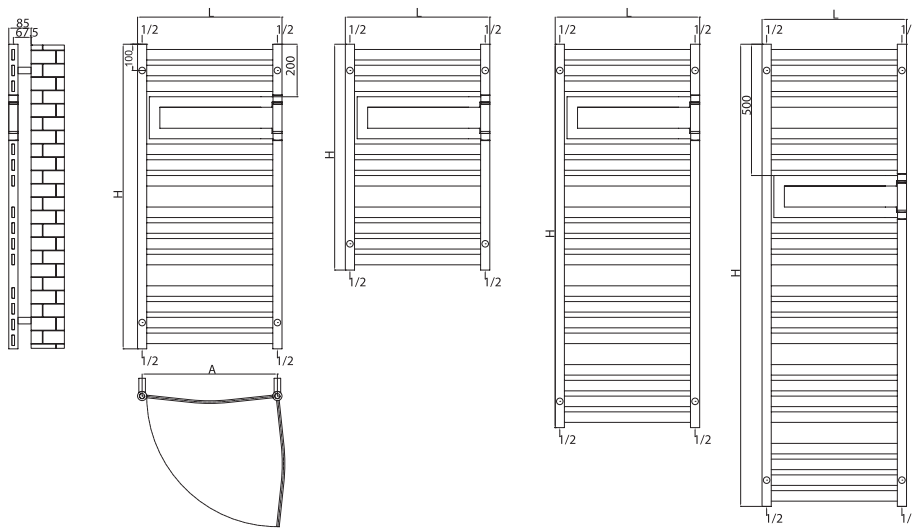

Max. working pressure/  
Presiune max. de lucru  
7 bar



Max. working temperature/  
Temperatură max. de lucru  
90°C



Mounting kit included/  
Kit montaj inclus  
K02 page 203



Factory pressure test/  
Presiune de probă:  
10bar



Elements/  
Elemente:  
40x10mm



Collectors/  
Colectori:  
Ø35mm

Code/ Cod	Finish / Finisaj	Height/ Înălțime (H) mm	Length/ Lățime (L) mm	Centres/ Interax (A) mm	No el/Nr elemente pcs	Weight/ Greu- tate kg	Volume/ Volum l	OUTPUT/PUTERE TERMICĂ (watt)			
								Δt=30°C W	Δt=50°C W	Δt=60°C W	electric W
VUNWF056/086V9010	RAL 9010 white/ alb*	860	565	530	12	8,80	3,00	204	393	491	300
VUNWF056/116V9010		1160	565	530	16	11,80	3,90	272	523	654	600
VUNWF056/146V9010		1460	565	530	20	14,70	4,90	340	653	817	900
VUNWF056/176V9010		1760	565	530	24	17,60	5,90	408	784	980	900
VUNWF056/086CR	Chrome / Cromat	860	565	530	12	8,80	3,00	157	302	378	300
VUNVFL056/116CR		1160	565	530	16	11,80	3,90	209	402	503	600
VUNWF056/146CR		1460	565	530	20	14,70	4,90	261	503	628	900
VUNWF056/176CR		1760	565	530	24	17,60	5,90	314	603	754	900

☛ We can make custom dimensions, after technical analysis. | Putem executa dimensiuni speciale, în urma unei analize tehnice.  
The mentioned code is for hydronic version. | Codul menționat este pentru versiunea hidraulică.

Hydraulic connections/  
Conexiuni hidraulice\*\*



S1

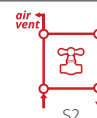

S2

\* For other colours, put your desired RADOX colour code instead of 9010 (standard white). For more details, see page 194  
Pentru alte culori, se pune codul culorii RADOX dorite în locul codului 9010 (standard alb). Mai multe detalii la pag. 194

\*\* When you order, you must mention the type of connection you require. The price changes according to the requirements.  
Când comandați trebuie să menționați tipul de alimentare necesar. Prețul se modifică în funcție de cerințe.



CLASSIC: RCF / RCN

# CLASSIC: RCF / RCN

Our underfloor convectors with natural (RCN) or forced convection (RCF) are modern equipment for heating air and demister large glass surfaces in offices, shopping centers, showrooms, winter gardens, apartments etc.

The convector body is installed in the floor, only wood or aluminum grilles will remain visible, available in a wide range of colours. It's the ideal solution for creating thermal comfort and for interiors where classical heating is not an option.

Convectorii de pardoseală cu convecție naturală (RCN) sau forțată (RCF) sunt echipamente moderne destinate încălzirii aerului și dezaburirii suprafețelor vitrate mari în spațiile de birouri, centre comerciale, showroom-uri, grădini de iarnă, apartamente etc.

Convectorul este instalat în pardoseală, iar după construirea pardoselei doar grilele de lemn sau aluminiu, vor rămâne vizibile într-o paletă largă de culori. Este soluția ideală pentru crearea confortului termic și pentru amenajările interioare care nu permit instalarea corpurilor de încălzire clasică.



## CONVECTORI DE PARDOSEALĂ RCF | UNDERFLOOR CONVECTORS RCF

		75 °C / 65 °C / 20 °C (ΔT 50 °C)													
Height (H)	Width (mm)	Speed	Sound dB(A)	90				110				130			
				190	260	330	410	190	260	330	410	190	260	330	410
900	0	-	-	85	94	126	144	93	103	178	204	107	114	250	287
	1	22	356	395	698	800	445	494	714	819	556	617	730	838	
	2	24	403	447	818	938	503	558	862	988	628	697	908	1042	
	3	37	419	464	875	1003	584	647	1102	1264	813	901	1388	1593	
1300	0	-	-	148	164	222	255	163	181	313	359	179	199	441	505
	1	24	639	709	1201	1377	799	886	1229	1409	998	1106	1258	1442	
	2	25	723	802	1408	1614	903	1001	1484	1702	1127	1250	1565	1794	
	3	38	751	833	1507	1728	1046	1160	1898	2176	1458	1616	2390	2740	
1700	0	-	-	203	224	304	349	223	247	428	491	246	272	603	691
	1	24	881	977	1632	1871	1100	1220	1670	1915	1374	1524	1709	1959	
	2	27	996	1105	1913	2193	1244	1380	2017	2312	1554	1723	2126	2437	
	3	38	1034	1147	2048	2347	1441	1598	2578	2955	2007	2226	3246	3721	
2100	0	-	-	276	306	417	478	304	337	587	672	335	372	825	945
	1	25	1220	1354	2206	2526	1524	1691	2258	2586	1904	2112	2311	2647	
	2	28	1380	1531	2587	2963	1723	1911	2726	3122	2152	2387	2873	3290	
	3	39	1434	1590	2768	3170	1997	2214	3485	3992	2781	3084	4389	5027	
2500	0	-	-	351	390	533	610	387	429	749	858	426	473	1053	1206
	1	25	1571	1742	2785	3191	1962	2176	2850	3266	2450	2717	2918	3343	
	2	29	1776	1970	3265	3741	2217	2460	3441	3942	2769	3072	3626	4154	
	3	39	1845	2046	3494	4003	2569	2849	4399	5041	3577	3968	5540	6347	
2900	0	-	-	427	473	649	744	471	522	914	1048	519	575	1287	1476
	1	25	1929	2140	3367	3860	2410	2673	3447	3951	3010	3339	3528	4045	
	2	30	2183	2420	3947	4525	2724	3021	4160	4769	3399	3769	4384	5026	
	3	39	2265	2513	4224	4842	3155	3499	5319	6098	4394	4873	6698	7679	
3300	0	-	-	504	558	768	881	556	616	1081	1239	613	680	1521	1744
	1	25	2294	2545	3952	4531	2866	3180	4046	4638	3582	3973	4141	4748	
	2	31	2595	2879	4634	5313	3240	3593	4883	5599	4044	4485	5145	5899	
	3	40	2695	2989	4959	5685	3754	4163	6244	7159	5229	5799	7863	9015	
3700	0	-	-	581	644	888	1018	641	711	1250	1433	707	784	1758	2016
	1	26	2666	2958	4540	5207	3331	3694	4648	5329	4160	4615	4757	5455	
	2	31	3016	3345	5324	6104	3765	4176	5609	6432	4700	5212	5911	6778	
	3	40	3132	3474	5696	6531	4361	4837	7173	8225	6073	6735	9034	10359	
4100	0	-	-	660	731	1010	1158	727	806	1421	1628	801	888	1998	2290
	1	26	3043	3376	5130	5880	3801	4217	5251	6018	4748	5267	5375	6160	
	2	31	3442	3818	6015	6894	4298	4767	6338	7264	5366	5952	6679	7654	
	3	40	3575	3965	6435	7375	4978	5521	8104	9288	6932	7689	10207	11698	
4500	0	-	-	738	818	1132	1230	813	902	1593	1730	896	993	2240	2433
	1	26	3425	3799	5722	6216	4279	4746	5858	6363	5346	5929	5997	6514	
	2	31	3874	4298	6709	7288	4836	5365	7069	7679	6037	6697	7449	8091	
	40	4023	4462	7178	7797	5603	6215	9039	9721	7804	8656	11384	12120		

● We can make custom dimensions, after technical analysis. | Putem executa dimensiuni speciale, în urma unei analize tehnice.

# CONVECTORI DE PARDOSEALĂ RCF | UNDERFLOOR CONVECTORS RCF

		90 °C / 70 °C / 20 °C (ΔT 60 °C)												
Height (H) Width (mm)	Speed	Sound dB(A)	90				110				130			
			190	260	330	410	190	260	330	410	190	260	330	410
900	0	-	107	119	160	183	118	131	225	259	130	144	318	365
	1	22	453	502	886	1016	565	627	907	1040	706	783	928	1064
	2	24	512	568	1038	1191	639	709	1094	1255	798	885	1153	1323
1300	3	37	532	590	1111	1274	741	821	1400	1605	1032	1144	1763	2023
	0	-	188	209	282	323	207	230	397	455	228	253	560	642
	1	24	812	901	1526	1749	1014	1125	1561	1790	1267	1405	1598	1832
1700	2	25	918	1018	1788	2050	1147	1272	1885	2161	1432	1588	1987	2278
	3	38	954	1057	1914	2194	1329	1473	2410	2763	1851	2053	3035	3480
	0	-	257	285	386	443	284	314	544	623	312	346	766	878
2100	1	24	1119	1241	2073	2376	1397	1550	2121	2431	1745	1935	2171	2488
	2	27	1265	1403	2430	2785	1580	1752	2561	2936	1973	2189	2700	3094
	3	38	1313	1457	2601	2981	1830	2029	3274	3753	2549	2827	4123	4726
2500	0	-	350	388	530	607	386	428	745	854	425	472	1048	1201
	1	25	1550	1719	2801	3208	1936	2147	2867	3284	2418	2682	2935	3362
	2	28	1752	1944	3285	3762	2188	2427	3462	3965	2733	3031	3649	4179
2900	3	39	1821	2019	3515	4026	2536	2812	4426	5070	3532	3916	5574	6384
	0	-	446	495	677	775	491	545	951	1090	541	601	1337	1532
	1	25	1995	2213	3537	4052	2491	2763	3620	4148	3111	3451	3706	4246
3300	2	29	2255	2502	4147	4751	2816	3124	4370	5007	3516	3901	4604	5276
	3	39	2343	2599	4437	5084	3262	3619	5587	6402	4543	5039	7036	8061
	0	-	543	601	825	945	598	662	1161	1331	659	730	1635	1874
3700	1	25	2450	2717	4276	4902	3061	3394	4377	5018	3823	4240	4481	5137
	2	30	2772	3074	5013	5747	3459	3836	5283	6056	4317	4787	5568	6383
	3	39	2877	3191	5364	6149	4007	4444	6755	7744	5580	6189	8507	9752
4100	0	-	640	709	976	1119	706	782	1373	1574	779	863	1932	2215
	1	25	2913	3232	5019	5755	3640	4038	5138	5891	4549	5046	5259	6030
	2	31	3296	3656	5886	6748	4114	4563	6201	7110	5136	5696	6534	7492
4500	3	40	3423	3796	6297	7220	4767	5287	7930	9092	6640	7364	9986	11449
	0	-	738	818	1128	1293	814	902	1587	1820	898	995	2233	2561
	1	26	3386	3756	5766	6612	4230	4692	5903	6768	5284	5861	6042	6928
900	2	31	3831	4249	6761	7753	4782	5303	7124	8169	5969	6619	7507	8608
	3	40	3978	4412	7233	8294	5539	6143	9110	10446	7712	8554	11473	13156
	0	-	838	929	1283	1470	924	1024	1804	2068	1018	1128	2537	2908
1300	1	26	3865	4287	6515	7467	4828	5355	6669	7643	6030	6689	6826	7824
	2	31	4371	4849	7639	8755	5458	6054	8049	9226	6815	7559	8482	9721
	3	40	4540	5036	8172	9367	6322	7012	10189	10971	8803	9765	12704	12849
1700	0	-	938	1039	1438	1562	1033	1145	2023	2197	1138	1262	2845	3090
	1	26	4350	4825	7267	7894	5435	6028	7439	8081	6789	7530	7616	8273
	2	31	4920	5458	8520	9255	6142	6813	8978	9752	7667	8505	9460	10276
2100	3	40	5109	5667	9115	9902	7116	7893	10906	11605	9911	10993	13048	13601

		50 °C / 40 °C / 20 °C (ΔT 25 °C)												
Height (H) Width (mm)	Speed	Sound dB(A)	90				110				130			
			190	260	330	410	190	260	330	410	190	260	330	410
900	0	-	34	38	51	58	37	42	71	82	41	46	101	115
	1	22	143	159	280	322	179	198	287	329	224	248	294	337
	2	24	162	180	329	377	202	224	346	397	252	280	365	419
1300	3	37	168	187	352	403	235	260	443	508	327	362	558	640
	0	-	60	66	89	102	66	73	126	144	72	80	177	203
	1	24	257	285	483	554	321	356	494	566	401	445	506	580
1700	2	25	291	322	566	649	363	402	597	684	453	503	629	721
	3	38	302	335	606	694	420	466	763	874	586	650	961	1101
	0	-	81	90	122	140	90	99	172	197	99	109	242	278
2100	1	24	354	393	656	752	442	490	671	769	552	612	687	787
	2	27	400	444	769	881	500	554	811	929	624	693	854	979
	3	38	416	461	823	943	579	642	1036	1188	807	895	1305	1495
2500	0	-	111	123	168	192	122	135	236	270	135	149	332	380
	1	25	491	544	887	1015	613	680	907	1039	765	849	929	1064
	2	28	554	615	1040	1191	692	768	1096	1255	865	959	1155	1322
2900	3	39	576	639	1112	1274	802	890	1401	1604	1118	1239	1764	2020
	0	-	141	157	214	245	155	173	301	345	171	190	423	485
	1	25	631	700	1119	1282	788	874	1146	1313	985	1092	1173	1344
3300	2	29	714	792	1312	1504	891	989	1383	1584	1113	1234	1457	1670
	3	39	741	822	1404	1609	1032	1145	1768	2026	1438	1595	2226	2551
	0	-	172	190	261	299	189	210	367	421	208	231	517	593
3700	1	25	775	860	1353	1551	969	1074	1385	1588	1210	1342	1418	1626
	2	30	877	973	1586	1819	1095	1214	1672	1917	1366	1515	1762	2020
	3	39	910	1010	1698	1946	1268	1406	2138	2451	1766	1959	2692	3086
4100	0	-	202	224	309	354	223	248	434	498	246	273	611	701
	1	25	922	1023	1588	1821	1152	1278	1626	1864	1439	1597	1664	1908
	2	31	1043	1157	1863	2135	1302	1444	1962	2250	1625	1803	2068	2371
4500	3	40	1083	1201	1993	2285	1509	1673	2509	2877	2101	2331	3160	3623
	0	-	234	259	357	409	258	286	502	576	284	315	707	810
	1	26	1072	1189	1825	2093	1339	1485	1868	2142	1672	1855	1912	2192
900	2	31	1212	1345	2140	2453	1513	1678	2254	2585	1889	2095	2375	2724
	3	40	1259	1396	2289	2625	1753	1944	2883	3306	2441	2707	3631	4163
	0	-	265	294	406	465	292	324	571	654	322	357	803	920
1300	1	26	1223	1357	2062	2363	1528	1695	2110	2419	1908	2117	2160	2476
	2	31	1383	1534	2417	2771	1727	1916	2547	2920	2157	2392	2684	3076
	3	40	1437	1594	2586	2964	2001	2219	3257	3733	2786	3090	4102	4701
1700	0	-	297	329	455	494	327	362	640	695	360	399	900	978
	1	26	1377	1527	2300	2498	1720	1908	2354	2557	2148	2383	2410	2618
	2	31	1557	1727	2696	2929	1944	2156	2841	3086	2426	2691	2994	3252
2100	3	40	1617	1793	2885	3134	2252	2498	3633	3907	3136	3479	4575	4871

# CONVECTORI DE PARDOSEALĂ RCN | UNDERFLOOR CONVECTORS RCN

75 °C / 65 °C / 20 °C (ΔT 50 °C)																
Height (H)	90					110					130					
Width (mm)	140	170	260	330	410	140	170	260	330	410	140	170	260	330	410	
900	129	139	187	244	280	164	177	239	305	350	180	195	262	330	378	
1300	193	208	279	385	441	245	264	356	481	551	270	291	392	518	593	
1700	254	274	370	525	602	324	350	472	656	752	357	385	518	707	811	
2100	319	344	464	668	765	406	438	591	834	955	447	482	650	899	1030	
Length (L)	2500	390	420	566	815	933	496	535	721	1016	1165	546	588	793	1095	1255
	2900	459	495	668	960	1101	584	631	850	1198	1373	643	693	935	1292	1481
	3300	529	571	769	1107	1269	675	727	980	1383	1585	741	800	1078	1492	1711
	3700	599	646	871	1254	1438	763	823	1110	1565	1795	840	906	1220	1688	1936
	4100	669	722	973	1401	1605	853	920	1240	1748	2003	937	1011	1363	1886	2162
	4500	739	797	1075	1547	1774	942	1015	1369	1931	2213	1036	1118	1505	2082	2387

90 °C / 70 °C / 20 °C (ΔT 60 °C)																
Height (H)	90					110					130					
Width (mm)	140	170	260	330	410	140	170	260	330	410	140	170	260	330	410	
900	163	176	237	310	355	208	225	303	388	445	229	247	332	419	480	
1300	245	264	355	489	560	311	335	452	610	700	343	369	498	657	754	
1700	323	348	470	667	765	411	444	599	833	955	453	489	658	898	1029	
2100	406	437	589	848	972	515	556	751	1059	1213	567	612	826	1142	1308	
Length (L)	2500	495	533	719	1035	1186	630	679	915	1291	1479	693	747	1007	1391	1594
	2900	583	629	849	1220	1398	742	801	1080	1521	1744	817	881	1188	1641	1881
	3300	672	725	977	1406	1612	857	924	1245	1756	2013	941	1016	1369	1895	2172
	3700	761	821	1107	1592	1826	969	1045	1410	1988	2280	1067	1151	1550	2144	2458
	4100	850	917	1236	1779	2039	1083	1168	1574	2220	2544	1190	1284	1731	2395	2745
	4500	939	1013	1366	1965	2253	1196	1290	1739	2452	2811	1316	1419	1912	2644	3031

50 °C / 40 °C / 20 °C (ΔT 25 °C)																
Height (H)	90					110					130					
Width (mm)	140	170	260	330	410	140	170	260	330	410	140	170	260	330	410	
900	52	56	75	98	112	66	71	96	123	141	72	78	105	133	152	
1300	78	83	112	155	177	98	106	143	193	221	108	117	157	208	238	
1700	102	110	149	211	242	130	140	190	264	302	143	155	208	284	326	
2100	128	138	187	268	307	163	176	238	335	384	180	194	261	361	414	
Length (L)	2500	157	169	228	327	375	199	215	290	409	468	219	236	319	440	504
	2900	185	199	269	386	442	235	253	342	481	552	258	279	376	519	595
	3300	213	229	309	445	510	271	292	394	556	637	298	321	433	600	687
	3700	241	260	350	504	578	307	331	446	629	721	338	364	490	678	778
	4100	269	290	391	563	645	343	370	498	703	805	377	406	548	758	869
	4500	297	320	432	622	713	378	408	550	776	890	417	449	605	837	959

☛ We can make custom dimensions, after technical analysis. | Putem executa dimensiuni speciale, în urma unei analize tehnice.

Vedere de sus RCN | Upper view RCN

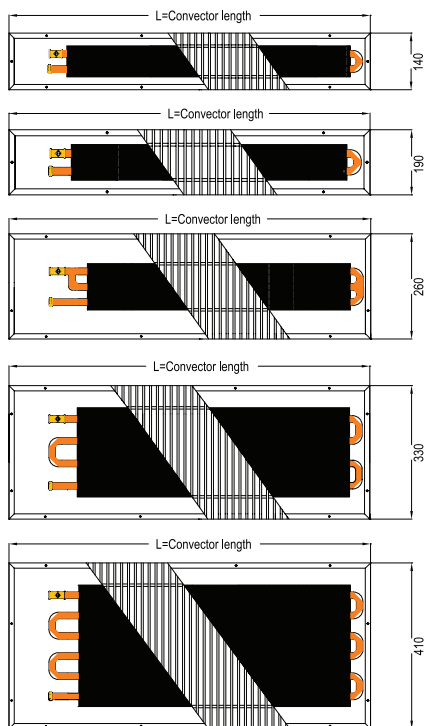

Vedere de sus RCF | Upper view RCF

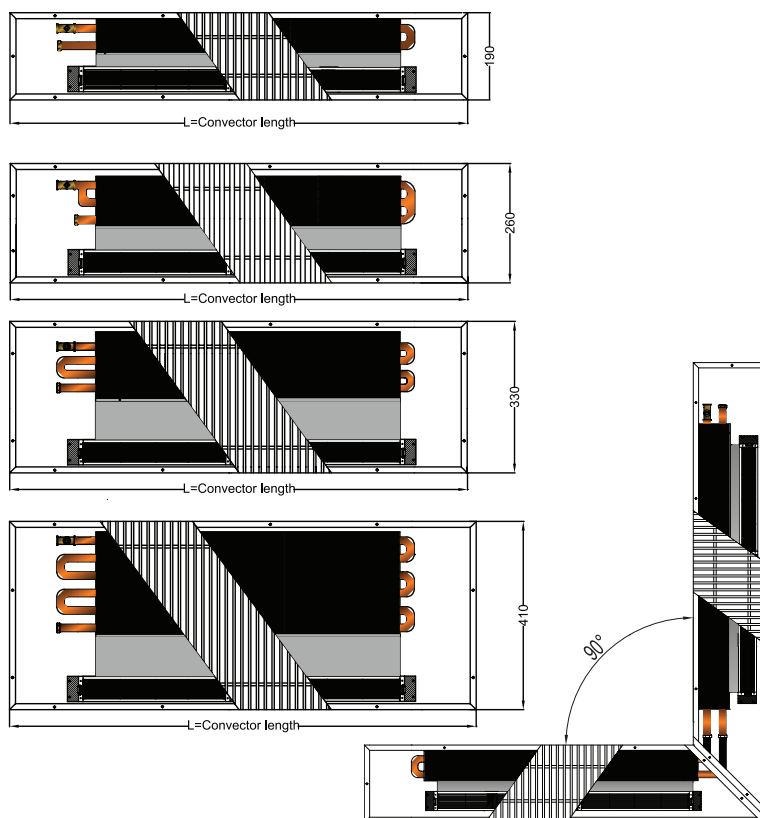



SPECIAL PROJECTS  
RCNA/RCFA 1 RCNZ/RCFZ

# SPECIAL PROJECTS

## RCNa/RCFa + RCNz/RCFz

Our customized underfloor convectors can copy different shapes of the room: RCNa/RCFa (arc) and RCNz/RCFz (zig-zag). With a curved heat exchanger and a custom made aluminum frame, RADOX can produce customized underfloor convectors for any architectural style, with exceptional quality and very energy efficient.

Convectorii noștri făcuți după nevoile clientului pot copia diferite forme ale camerei: RCNa/RCFa (arc) și RCNz/RCFz (zig-zag). Cu un schimbător de căldură curbat și un cadru de aluminiu personalizat, RADOX poate produce convectori de pardoseală făcuți la comandă pentru orice stil arhitectural, cu o calitate excepțională și foarte eficiente energetic.



### RCNa/RCFa

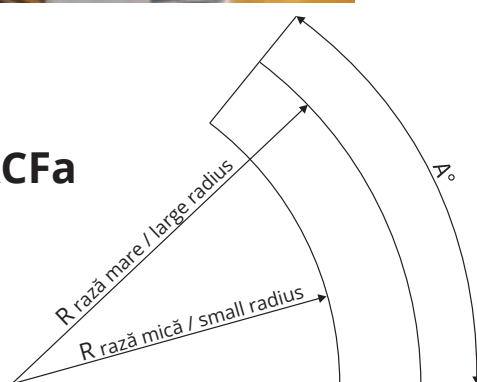

- R rază mare / large radius
- R rază mică / small radius
- A°

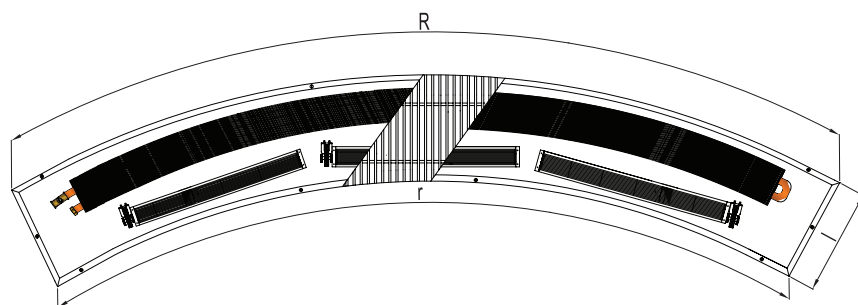

### RCNz/RCFz

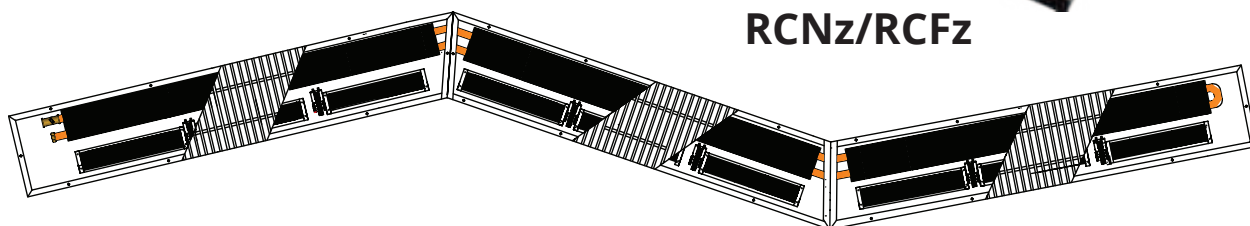



CLIMA: RCFR



# CLIMA: RCFR

Highly efficient, our CLIMA underfloor convectors are providing optimum conditioning system in front of height glazing - not only they heat in winter, but they cool in summer! In hot summer days, they will stop overheating all modern glass facades and let you enjoy the daylight, the beautiful view, in an optimum indoor climate! And during the cold winter days, they will create an air curtain that will act as a natural barrier that separates cold and hot air, will minimize heat losses whilst will increase the entire heating system efficiency.

Convectorii de pardoseală CLIMA asigură un sistem de climatizare optim în zona suprafețelor mari vitrate - nu numai că încălzesc în timpul iernii, dar și răcesc în timpul verii! Carcasa din inox și construcția specială asigură preluarea și evacuarea condensului în timp ce opresc supraîncălzirea fațadelor moderne din sticlă în zilele fierbinți de vară, astfel încât să vă bucurați de lumina zilei, de priveliștea minunată, într-un climat interior optim! Iar în zilele reci de iarnă, ei vor crea o perdea de aer, care va acționa ca o barieră naturală care separă aerul rece de cel cald, vor reduce pierderile de căldură în timp ce eficiența întregului sistem de încălzire va crește.

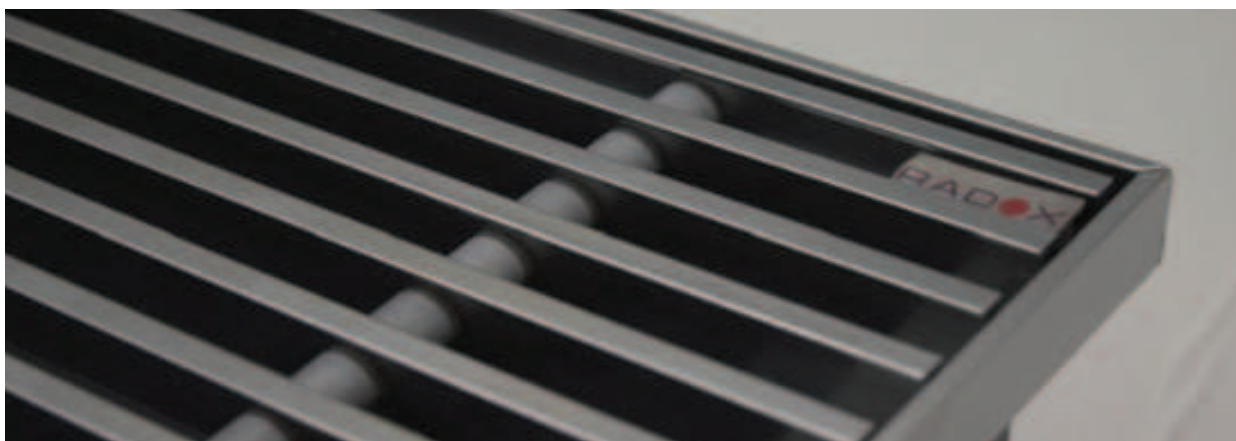

● We can make custom dimensions, after technical analysis. | Putem executa dimensiuni speciale, în urma unei analize tehnice.

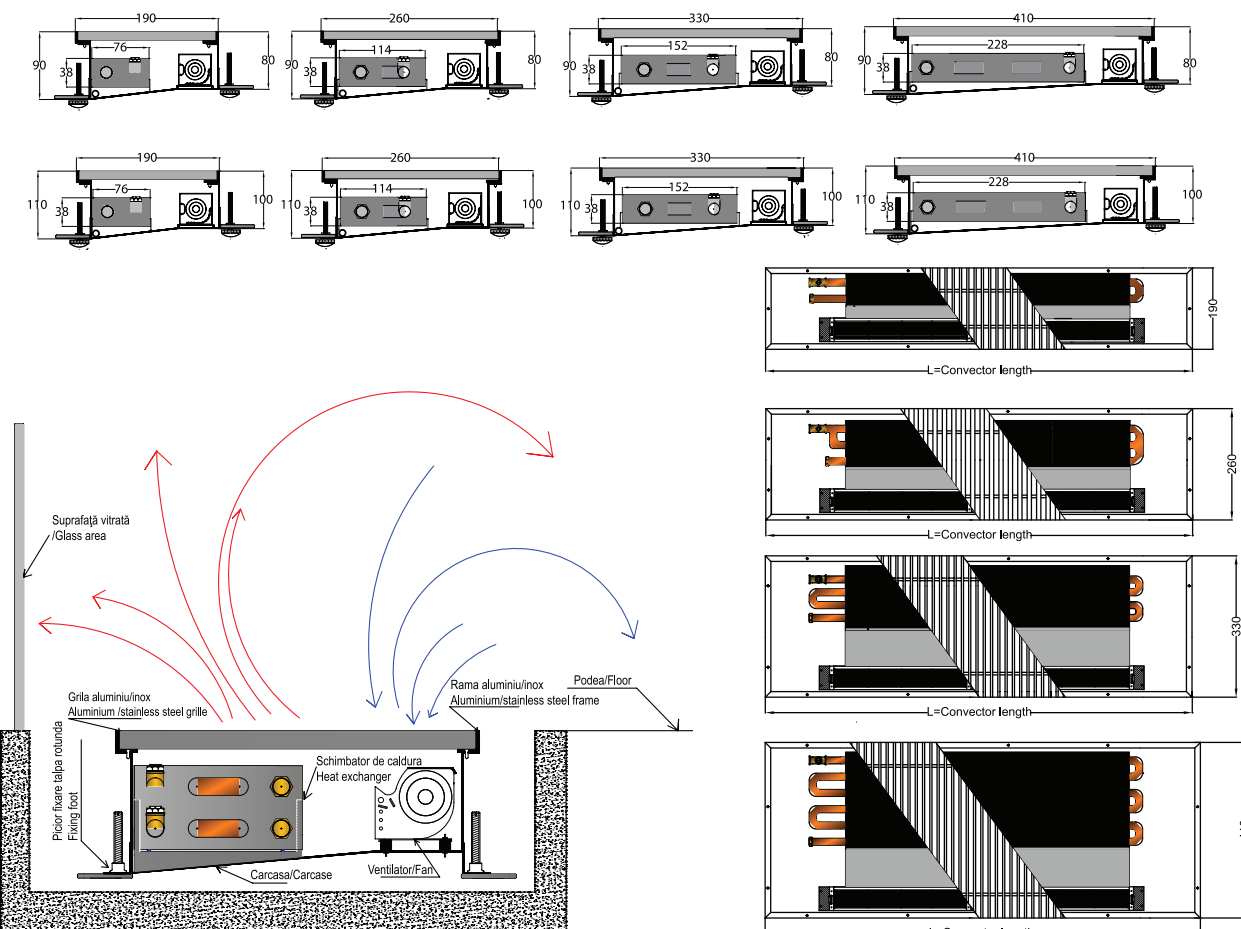



POOL: RCFU

# PISCINA / POOL: RCFU

Smart and effective, our POOL underfloor convectors are the solution for environment with high humidity such as pool areas and spa centers.

Room design and décor can be complimented with a range of elegant stainless steel or aluminum grilles.

The humidity resistant construction makes this product a winner in wet environment heating solution category, distributing heat while preventing condensation in rooms.

*Soluții inteligente și eficiente, convectorii de pardoseală POOL sunt destinați zonelor cu umiditate ridicată, cum ar fi piscine interioare și centre spa. Pentru un design desăvârșit, convectorii POOL sunt echipați cu grile elegante din inox sau aluminiu, acestea fiind singurul element vizibil la suprafață, restul fiind încadrat în pardoseală.*

*Construcția rezistentă la umiditate face ca acest produs să fie soluția perfectă pentru încălzirea zonelor umede, distribuind căldură în timp ce previne apariția condensului în camere.*



● We can make custom dimensions, after technical analysis. | Putem executa dimensiuni speciale, în urma unei analize tehnice.

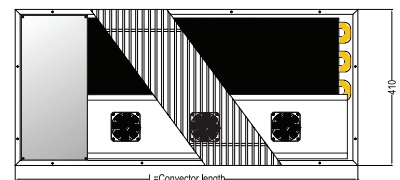
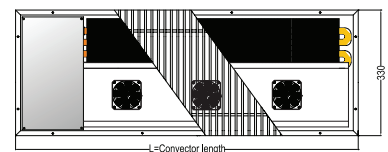
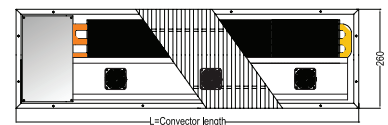
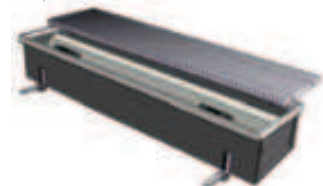
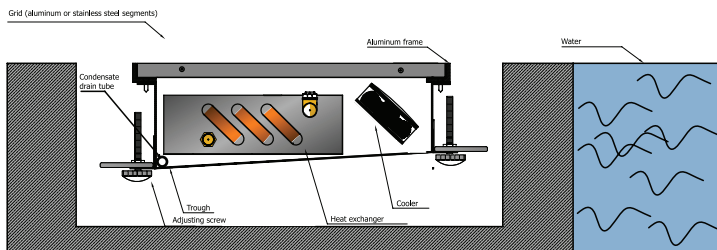
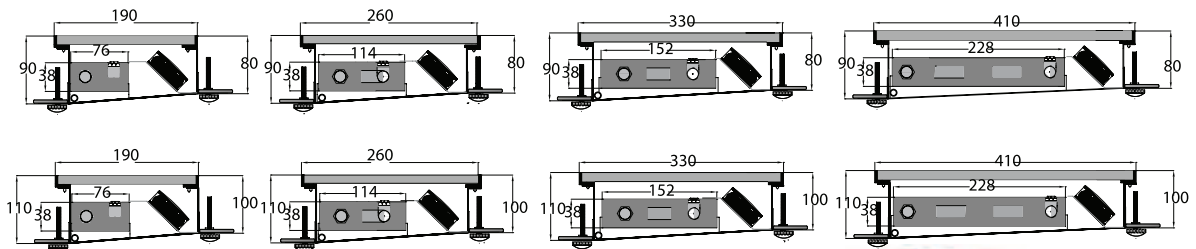



## Circle

In its electric version, CIRCLE, boasting a unique design, comes in 3 models, each offering different thermal powers. CIRCLE Electric is highly versatile, able to adapt to the needs of any space.

În varianta electrică, CIRCLE, cu designul său distinctiv, este disponibil în 3 modele, fiecare având puteri termice diferite. CIRCLE Electric este extrem de versatil, putând să se adapteze nevoilor oricărui spațiu.

Height Înălțime (H)	Length Lățime (L)	No el Nr elemente	Weight Greutate	Electric options Opțiuni electrice
mm	mm	pcs	kg	w
800	250	14	10	500
1200	250	20	14	600
1800	250	30	21	1200



FAN represents the aesthetic evolution of the electric radiator, thanks to the squared profile of its elements. The electronic components ensure high thermal power (up to 1000 Watts) to meet every need.

FAN reprezintă evoluția estetică a radiatorului electric, datorită profilului pătrat al elementelor sale. Componentele electronice asigură o putere termică ridicată (până la 1000 de wați) pentru a satisface fiecare necesitate.

# Fan



Height Înălțime (H)	Length Lățime (L)	No el Nr elemente	Weight Greutate	Electric options Opțiuni electrice
mm	mm	pcs	kg	w
1800	285	4	24	600
1800	451	6	36	800

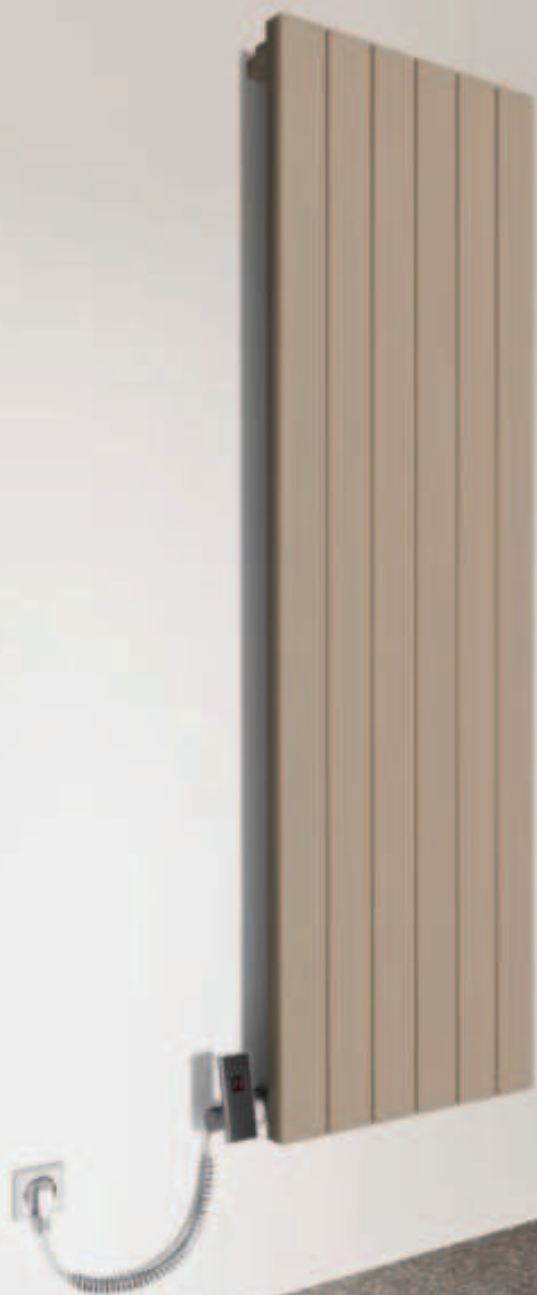

## Heaton

With its linear, rectangular shape, this radiator offers efficient thermal output for any room. Its discreet design seamlessly integrates into various interiors. Available in 3 lengths and 2 heights (600 and 1800 mm), HEATON Electric embodies

contemporary style.

Cu forma sa liniară și rectangulară, acest radiator oferă o putere termică eficientă pentru orice cameră. Designul său discret se integrează perfect în diverse amenajări interioare. Disponibil în 3 lățimi și 2 înălțimi (600 și 1800 mm), HEATON Electric îmbrățișează stilul contemporan.

Height Înălțime (H) mm	Length Lățime (L) mm	No el Nr elemente pcs	Weight Greutate kg	Electric options Opțiuni electrice w
600	717	8	45	600
600	899	10	56	800
1800	270	3	33	600
1800	555	6	66	1,200



INKA is a continuous geometry that enhances your environment with a refined search for details while emitting a soft radiator heat. Thanks to an effective electronic thermostat temperature is kept balanced.

INKA are o geometrie continuă ce îmbunătățește orice interior prin forma sa rafinată, emițând în același timp o căldură plăcută. Cu ajutorul unui termostat electronic, temperatura este menținută constantă și echilibrată.

# Inka

Height Înălțime (H)	Length Lățime (L)	No el Nr elemente	Weight Greutate	Electric options Opțiuni electrice
mm	mm	pcs	kg	w
650	580	4	14	300
1000	580	6	21	600
1350	580	8	29	600
1700	580	10	36	800



## Kolona SP35

In its electric version, KOLONA SP35 represents the perfect solution for living spaces where a conventional connection to the heating system is neither feasible nor practical. It comes in three different heights and lengths. Also can be used in mixed systems.

În versiunea sa electrică, KOLONA SP35 reprezintă soluția ideală pentru spațiile de locuit în care o conexiune tradițională la sistemul de încălzire nu este fie fezabilă, fie practică. Este disponibil în trei înălțimi și lungimi diferite. De asemenea, poate fi folosit în sisteme mixte.

Height Înălțime (H) mm	Length Lățime (L) mm	No el Nr elemente pcs	Weight Greutate kg	Electric options Opțiuni electrice w
1000	105	2	5	120
1000	175	3	8	200
1000	245	4	11	300
1200	105	2	6	120
1200	175	3	10	200
1200	245	4	13	300
1500	105	2	8	200
1500	175	3	12	300
1500	245	4	16	400





KING, an electric radiant convector, boasts sleek lines and advanced technological features. Offered in two lengths (1000 and 1500 mm) with various dimensional options, KING electric ensures high thermal output (up to 1500 Watts) to meet diverse needs.

KING electric se remarcă prin liniile sale clare și tehnologia încorporată. Disponibil în două lungimi (1000 și 1500 mm) și cu diverse opțiuni dimensionale, KING electric oferă o putere termică ridicată (de până la 1500 de wați) pentru a satisface diferitele nevoi de încălzire.

# King



	Height Înălțime (H) mm	Length Lățime (L) mm	No el Nr elemente pcs	Weight Greutate kg	Electric options Opțiuni electrice w
21	280	1000	8	25	900
	280	1500	8	37	1,200
	350	1000	10	31	1,200
	350	1500	10	46	1,500
	420	1000	12	38	1,200
	420	1500	12	55	1,500
22	630	1000	18	61	1,500
	280	1000	8	28	1,500
	280	1500	8	40	1,500
	350	1000	10	35	1,500
	350	1500	10	51	1,500
	420	1000	12	42	1,500
	420	1500	12	61	1,500
	630	1000	18	69	1,500



## Nova PMIX2

NOVA PMIX2 is the design radiator that ensures shape fluidity and delivers beauty and comfort without overcrowding. With 9 standard configurations available, NOVA PMIX2 ensures efficient thermal output (ranging from 300 to 1000 Watts) to meet various needs.

NOVA Electric este radiatorul de design care garantează fluiditatea formei și aduce frumusețe și confort fără a supraîncărca spațiul. Cu 9 configurații standard disponibile, NOVA Electric asigură o producție termică eficientă (între 300 și 1000 de wați) pentru diverse nevoi.

Height Înălțime (H) mm	Length Lățime (L) mm	No el Nr elemente pcs	Weight Greutate kg	Electric options Opțiuni electrice w
1200	280	4	13	300
1200	420	6	19	600
1200	630	9	29	800
1500	280	4	16	500
1500	420	6	23	600
1500	630	9	35	1200
1800	280	4	19	600
1800	420	6	28	800
1800	630	9	42	1200



NOVA PMIX2 GLASS combines a strict rectangular profile with design, enhancing any environment. With mirror or an image of your choice, NOVA PMIX2GLASS is available in 3 sizes and thermal powers, and can be installed both horizontally and vertically.

NOVA PMIX2 GLASS îmbină profilul rectangular strict și designul, îmbunătățind orice ambient. Cu sticlă sau o imagine la alegerea dvs., NOVA PMIX2GLASS este disponibil în 3 dimensiuni și puteri termice și poate fi instalat atât orizontal, cât și vertical.

Height Înălțime (H)	Length Lățime (L)	No el Nr elemente	Weight Greutate	Electric options Opțiuni electrice
mm	mm	pcs	kg	w
1200	420	6	24	600
1500	420	6	30	600
1800	420	6	36	800
1200	420	6	24	600
1500	420	6	30	600
1800	420	6	36	800

## Nova PMIX2 Glass





## Nova PPMIX2

NOVA PPMIX2 features a flat profile and is suitable for any living space where a standard heating system connection is not feasible. Available in 9 sizes, it can also be used in hybrid, mixed systems.

NOVA PPMIX2 se caracterizează prin forma sa plată și este soluția ideală pentru spațiile de locuit în care o conexiune normală la sistemul de încălzire nu este posibilă sau convenabilă. Disponibil în 9 dimensiuni, poate fi folosit și într-un sistem mixt.

Height Înălțime (H)	Length Lățime (L)	No el Nr elemente	Weight Greutate	Electric options Opțiuni electrice
mm	mm	pcs	kg	w
1207	378	4	16	300
1207	518	6	24	600
1207	728	9	31	800
1507	378	4	20	500
1507	518	6	30	600
1507	728	9	44	1200
1807	378	4	24	600
1807	518	6	35	800
1807	728	9	52	1200



PIGLET is available in the electric version in 4 standard dimensions. This model provides the most practical solution in situations where connection to the heating system is not feasible, or as an alternative integration solution, in hybrid/mixed systems.

PIGLET este disponibil în versiunea electrică în 4 dimensiuni standard. Acest model oferă cea mai practică soluție în situațiile în care o conexiune la sistemul de încălzire nu este fezabilă, sau ca soluție alternativă de integrare, în sisteme hibride/mixte.

# Piglet

Height Înălțime (H)	Length Lățime (L)	No el Nr elemente	Weight Greutate	Electric options Opțiuni electrice
mm	mm	pcs	kg	w
400	600	12	42	1000
400	700	14	49	1000
400	800	16	56	1500
400	900	18	62	1500



## RC Convector

The RC electric convector represents an aesthetic and technological innovation ensuring sleek design and contemporary appeal. It is offered in 12 dimensional configurations, suitable for electric use only or for integration into mixed systems.

Convectorii electrici RC reprezintă o inovație estetică și tehnologică ce garantează fluiditatea formei, fiind un produs contemporan veritabil. Disponibili în 12 configurații dimensionale, atât pentru utilizare electrică, cât și pentru sisteme mixte.

	Height Înălțime (H) mm	Length Lățime (L) mm	No el Nr ele- menți pcs	Weight Greutate kg	Electric options Opțiuni elec- trice w
N1	140	1200	4	16	600
	140	1500	4	20	900
	210	1200	6	24	1200
	210	1500	6	30	1500
	280	1200	8	32	1500
	280	1500	8	40	1500
N2	140	1200	4	20	900
	140	1500	4	25	1200
	210	1200	6	30	1500
	210	1500	6	38	1500
	280	1200	8	40	1500
	280	1500	8	50	1500
N3	140	1200	6	25	1200
	140	1500	6	32	1500
	210	1200	9	38	1500
	210	1500	9	48	1500
	280	1200	12	51	1500
	280	1500	12	69	1500



CELSIUS electric offers versatility in meeting the dual requirement of heating the bathroom and drying towels. It ensures uniform heat distribution while minimizing energy consumption.

CELSIUS electric este una dintre cele mai versatile alegeri pentru a satisface dubla nevoie de încălzire a băii și uscarea prosoapelor. Permite difuzarea uniformă a căldurii, cu un impact redus asupra consumului de energie.

Height Înălțime (H)	Length Lățime (L)	No el Nr elemente	Weight Greutate	Electric options Opțiuni electrice
mm	mm	pcs	kg	w
800	400	350	8	120
800	500	450	9	120
800	600	550	10	300
980	400	350	9	300
980	500	450	11	300
980	600	550	12	300
1200	500	450	14	500
1200	600	550	16	500
1470	500	450	17	600
1470	600	550	19	600
1790	500	450	20	600
1790	600	550	23	600

# Celsius





## Polter

POLTER electric provides the perfect solution for living spaces where a conventional connection to the central heating system is not feasible or convenient. Offered in 4 heights and 3 widths, it is also compatible with the mixed version.

POLTER electric reprezintă soluția ideală pentru spațiile de locuit în care o conexiune normală la sistemul central de încălzire nu este posibilă sau convenabilă. Disponibil în 4 înălțimi și 3 lățimi, este de asemenea potrivit pentru utilizarea în versiunea mixtă.

Height Înălțime (H) mm	Length Lățime (L) mm	No el Nr elemente pcs	Weight Greutate kg	Electric options Opțiuni electrice w
734	400	8	7	300
734	500	8	8	300
734	600	8	9	300
1154	400	12	11	300
1154	500	12	12	300
1154	600	12	13	600
1364	400	14	13	600
1364	500	14	14	600
1364	600	14	16	600
1784	400	18	16	600
1784	500	18	18	600
1784	600	18	20	600





The SCALA N Electric towel rail provides consistent warmth for both towels and the room. Available in various colors and finishes, it elevates any space with RADOX's iconic design and efficient heating.

SCALA N Electric oferă căldură constantă atât pentru prosoape, cât și pentru cameră. Disponibil în diferite culori și finisaje, el îmbunătățește orice spațiu cu designul iconic și încălzirea eficientă marca RADOX.

## Scala N



Height Înălțime (H)	Length Lățime (L)	No el Nr elemente	Weight Greutate	Electric options Opțiuni electrice
mm	mm	pcs	kg	w
800	400	18	9	300
800	450	18	10	300
800	500	18	11	500
800	600	18	15	500
1200	400	26	13	600
1200	450	26	14	600
1200	500	26	15	600
1200	600	26	18	900
1500	450	34	18	900
1500	500	34	20	900
1500	600	34	23	900
1800	450	39	21	900
1800	500	39	23	900
1800	600	39	26	1200



## Sunit P100

The SUNIT P100 electric radiator, with its understated and elegant design, seamlessly integrates into any interior style. Its combination of practicality and reliability makes this electric version of the Sunit P100 a good product for energy-efficient heating.

Radiatoarele electrice SUNIT P100, datorită liniilor discrete și elegante, se integrează perfect în orice tip de interior. Practicitatea și fiabilitatea completează această versiune electrică a radiatorului SUNIT P100, un produs de calitate și eficient din punct de vedere energetic.

Height Înălțime (H)	Length Lățime (L)	No el Nr elemente	Weight Greutate	Electric options Opțiuni electrice
mm	mm	pcs	kg	w
743	500	7	5	120
743	600	7	6	120
943	500	9	6	300
943	600	9	7	300
1143	500	11	8	300
1143	600	11	9	300
1443	500	13	10	300
1443	600	13	11	300
1743	500	16	12	500
1743	600	16	13	500



Introducing APOLLO Electric: a sleek steel towel warmer radiator that not only keeps your towels cozy but also ensures consistent room temperature. With options available in 3 heights and a width of 500 mm, it's both stylish and practical.

APOLLO Electric este un radiator elegant de baie, care nu doar menține prosoapele călduroase, ci și asigură o temperatură constantă în cameră. Disponibil în 3 înălțimi și cu o lățime de 500 mm, este atât elegant, cât și practic.

# Apollo

Height Înălțime (H)	Length Lățime (L)	No el Nr elemente	Weight Greutate	Electric options Opțiuni electrice
mm	mm	pcs	kg	w
700	500	6	9	300
1050	500	9	14	300
1400	500	12	18	500

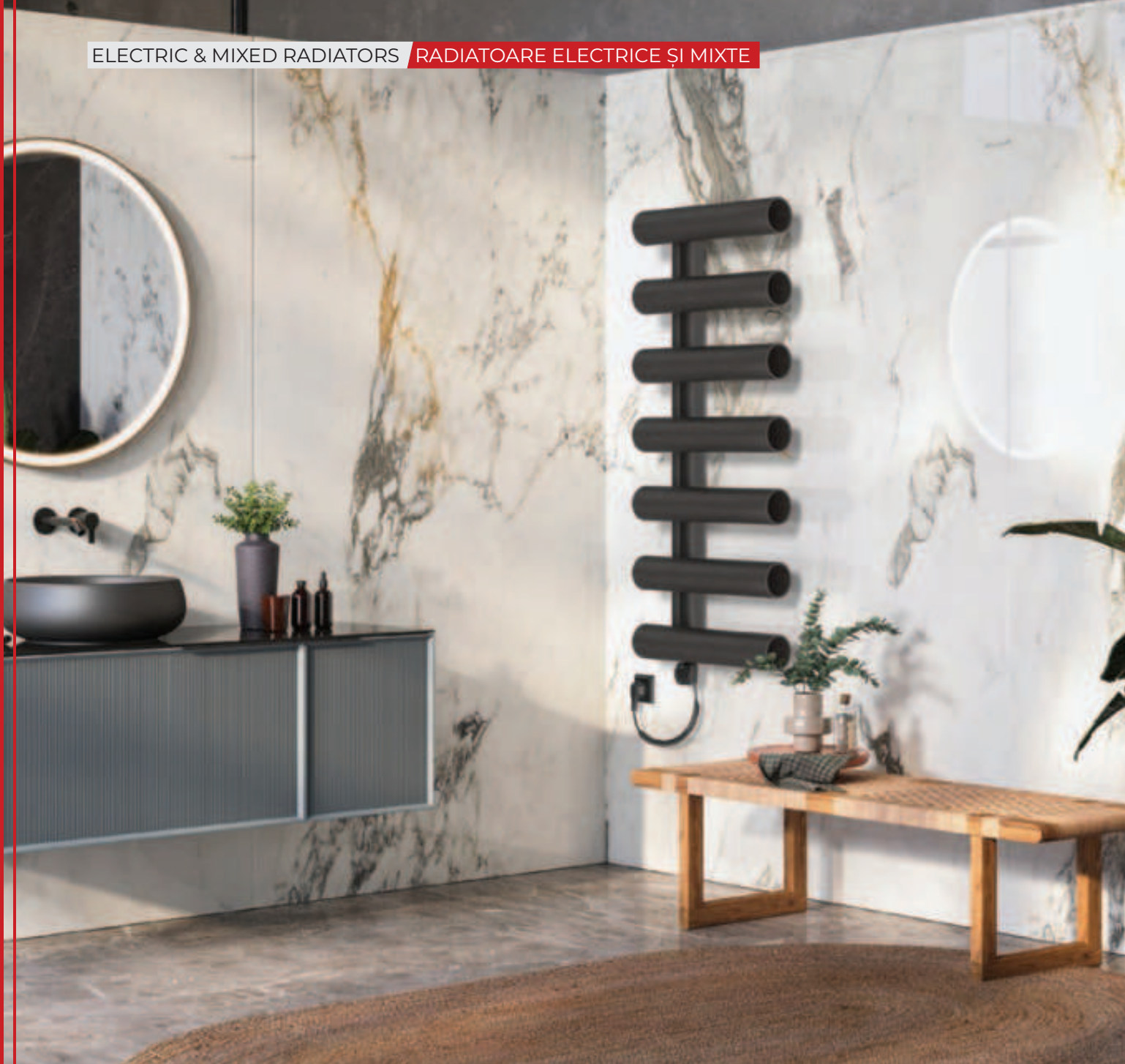

## Aramis

ARAMIS Electric: Crafted for ultimate bathroom comfort, it excels on electric power while seamlessly blending with other heating systems. Boasting slim columns and sturdy tubular rows, available in stylish colors or stainless steel, it elevates elegance and function in any space.

ARAMIS Electric: Conceput pentru un confort maxim în baie, funcționează electric, dar se integrează fără efort cu alte sisteme de încălzire. Cu colectori subțiri și elemente robuste, disponibil în culori elegante sau oțel inoxidabil, ARAMIS electric adaugă eleganță și funcționalitate în orice spațiu.

Height Înălțime (H)	Length Lățime (L)	No of Nr elemente	Weight Greutate	Electric options Opțiuni electrice
mm	mm	pcs	kg	w
800	500	5	27	900
1155	500	7	39	900
1512	500	9	50	1200



ARAMIS 2 Electric embodies the aesthetic advancement of towel rail radiators, with slender columns linked to thick tubular rows open at both ends. In its electric variant, ARAMIS 2 ensures ample thermal output (up to 1200 Watts) to meet diverse requirements.

ARAMIS 2 Electric reprezintă evoluția estetică a radiatorului de baie, datorită colectoarelor subțiri și elemeni tubulari deschisi la ambele capete. În această versiune electrică, ARAMIS 2 garantează o putere termică ridicată (până la 1200 de wați) pentru a răspunde diferitelor nevoi.

## Aramis 2



Height Înălțime (H)	Length Lățime (L)	No el Nr elemente	Weight Greutate	Electric options Opțiuni electrice
mm	mm	pcs	kg	w
800	500	5	27	800
1155	500	7	39	800
1512	500	9	50	1200



## Arial

ARIAL electric radiator boasts a sleek design with clean lines and simple geometry, seamlessly complementing any bathroom decor. With options in 4 heights and 2 lengths (500 and 600 mm), it adds character to the space.

Radiatoarele electrice ARIAL sunt modelate cu linii clare, o geometrie simplă ce se integrează armonios în orice baie, conferind personalitate oricărui ambient. Disponibile în 4 înălțimi și 2 lungimi (500 și 600 mm).

Height Înălțime (H)	Length Lățime (L)	No el Nr elemente	Weight Greutate	Electric options Opțiuni electrice
mm	mm	pcs	kg	w
650	500	2	4	120
650	600	2	4	120
1000	500	3	6	120
1000	600	3	7	200
1350	500	4	8	200
1350	600	4	9	200
1700	500	5	11	300
1700	600	5	11	300



AZTEC Electric excels as a superb main heating option and effortlessly blends with diverse heating setups. Offered in 3 height variations and a length of 600 mm, it ensures versatile warmth solutions.

AZTEC Electric se remarcă ca o excelentă sursă principală de căldură și se integrează fără probleme cu alte sisteme de încălzire. Disponibil în 3 înălțimi cu lungimea de 600 mm.

Aztec 

Height Înălțime (H)	Length Lățime (L)	No el Nr elemente	Weight Greutate	Electric options Opțiuni electrice
mm	mm	pcs	kg	w
915	600	6	12	300
1265	600	8	16	500
1615	600	10	20	800



## Bliss

BLISS Electric is exquisitely crafted with exact dimensions and thermal power to ensure unmatched bathroom comfort. Available in 3 heights and 2 widths of 500 and 600 mm, providing up to 1000 watts of soothing warmth.

BLISS Electric este conceput cu atenție având dimensiuni precise și putere termică bună pentru a asigura un confort deosebit în baie. Disponibil în 3 înălțimi și în 2 lățimi de 500 și 600 mm, furnizând până la 1000 de wați de căldură plăcută.

Height Înălțime (H)	Length Lățime (L)	No el Nr elemente	Weight Greutate	Electric options Opțiuni electrice
mm	mm	pcs	kg	w
801	500	22	9	300
801	600	22	11	300
1193	500	33	14	300
1193	600	33	16	600
1779	500	51	22	600
1779	500	51	25	600





BOKA Electric is a modern and effective electric towel radiator, available in 3 heights and a length of 600 mm. With options of 300 or 600 watts, it ensures consistent room temperature and warm towels for ultimate comfort.

BOKA Electric este un radiator modern și eficient, disponibil în 3 înălțimi și o lungime de 600 mm. Cu opțiuni de 300 sau 600 de wați, asigură o temperatură constantă în cameră și prosoape calde pentru un confort maxim.

Boka 

Height Înălțime (H)	Length Lățime (L)	No el Nr elemente	Weight Greutate	Electric options Opțiuni electrice
mm	mm	pcs	kg	w
740	600	5	11	300
1265	600	8	17	500
1790	600	11	24	600



## Break Q

BREAK Q electric is a modern and energy-efficient radiator, providing high-quality design to enhance any space. Available in two heights with lengths of 500 and 600 mm, it adds a touch of elegance through its wide variety of finishes.

BREAK Q electric este o alternativă modernă și energetic eficientă, furnizând un design de înaltă calitate pentru a îmbunătăți orice spațiu. Disponibil în 2 înălțimi cu lungimi de 500 și 600 mm, aduce o notă de eleganță prin varietatea sa bogată de finisaje.

Height Înălțime (H)	Length Lățime (L)	No of Nr elemente	Weight Greutate	Electric options Opțiuni electrice
mm	mm	pcs	kg	w
1200	500	23	20	600
1200	600	23	23	600
1560	500	29	26	900
1560	600	29	29	900



DORA 70 Electric is a chic and elegant electric towel radiator. It comes in all RADOX colors and in sleek chrome plated finish, with 2 height options and a width of 500 mm. DORA 70 is an efficient electric heating solution that can also be integrated into hybrid systems

DORA 70 Electric este un radiator electric șic și elegant. Este disponibil în toate culorile RADOX și în finisaj crom lucios, cu 2 opțiuni de înălțime și o lățime de 500 mm. DORA 70 reprezintă o soluție eficientă de încălzire electrică ce poate fi integrată și în sisteme hibride/mixte.

## Dora 70



Height Înălțime (H)	Length Lățime (L)	No el Nr elemente	Weight Greutate	Electric options Opțiuni electrice
mm	mm	pcs	kg	w
810	500	6	11	300
1248	500	9	16	600



## Empire

EMPIRE Electric in its electric version embodies the classic English-style towel rail, ideal where traditional central heating connection is impractical. Available in 3 heights and 3 lengths, it exudes elegance and energy efficiency, also compatible with hybrid systems.

În versiunea electrică, EMPIRE Electric aduce stilul clasic al radiatorului de baie englezesc, perfect pentru locurile unde conexiunea la încălzirea centrală este dificilă. Disponibil în 3 înălțimi și 3 lungimi, emană eleganță autentică, fiind eficient energetic și compatibil cu sistemele mixte/hibride.

Height Înălțime (H)	Length Lățime (L)	No el Nr elemente	Weight Greutate	Electric options Opțiuni electrice
mm	mm	pcs	kg	w
480	480	3	4	120
920	600	5	8	300
1000	700	5	9	300



LINX Electric embodies elegance with a subtle yet distinct personality, characterized by its oval tube shape and unique two-tone finish exclusive to Radox. Whether used solely electrically or in a hybrid system, LINX Electric excels in performance and style.

LINX Electric este un radiator elegant, cu o personalitate bine conturată, datorită formei ovale a elementelor, precum și datorită finisajului unic în două nuanțe disponibil doar în gama Radox. LINX electric este un produs eficient în utilizarea exclusiv electrică sau într-un sistem mixt.

Linx 

Height Înălțime (H)	Length Lățime (L)	No el Nr elemente	Weight Greutate	Electric options Opțiuni electrice
mm	mm	pcs	kg	w
736	500	8	13	300
936	500	10	16	500
1136	500	12	19	600
1336	500	14	22	600
1536	500	16	25	600



## Premier XL

PREMIER XL Electric is a stainless-steel towel warmer, backed by 20 year guarantee, offering both elegance and essential warmth and comfort. It's also offered in painted stainless steel, with 9 dimensional configurations and electric outputs ranging from 200 to 600 watts.

PREMIER XL Electric este un port-prosop din oțel inoxidabil, cu o garanție de 20 de ani, oferind atât eleganță, cât și căldură și confort. Este disponibil și în oțel inoxidabil vopsit, cu 9 configurații dimensionale și puteri electrice cuprinse între 200 și 600 de wați.

Height Înălțime (H) mm	Length Lățime (L) mm	No el Nr elemente pcs	Weight Greutate kg	Electric options Opțiuni electrice w
800	450	16	9	300
800	500	16	10	300
800	600	16	11	300
1200	450	24	14	300
1200	500	24	15	300
1200	600	24	17	400
1800	450	37	21	400
1800	500	37	22	600
1800	600	37	25	600



PREMIER XL SPACE electric is the newest addition in our stainless-steel lineup, available in mixed or electric-only versions. Ideal for spaces without conventional heating connections, it excels in mixed systems. With 5 configurations, it's an intelligent solution for any setting.

PREMIER XL SPACE electric este cel mai nou produs în gama noastră de radiatoare din oțel inoxidabil, disponibil în varianta mixte sau doar electric. Ideal pentru spațiile fără conexiuni convenționale la încălzirea centrală, excelând în sistemele mixte. este o soluție inteligentă pentru orice ambient.

## Premier XL Space



Height Înălțime (H)	Length Lățime (L)	No el Nr elemente	Weight Greutate	Electric options Opțiuni electrice
mm	mm	pcs	kg	w
608	538	4	5	300
608	800	4	6	300
608	1000	4	7	300
1076	538	7	9	500
1700	538	11	14	500



## Quebis

QUEBIS Electric is a radiator that ensures consistent room temperature. Offered in 3 sizes, with electric outputs ranging from 300 to 600 watts, QUEBIS Electric is both practical and stylish.

QUEBIS electric este un radiator care asigură o temperatură uniformă în camera în care este instalat. Disponibil în 3 dimensiuni, cu puteri electrice cuprinse între 300 și 600 de wați, QUEBIS electric este practic și elegant.

Height Înălțime (H) mm	Length Lățime (L) mm	No el Nr elemente pcs	Weight Greutate kg	Electric options Opțiuni electrice w
700	500	11	9	300
1100	500	18	14	500
1550	500	26	20	600





RIVER Electric features a circular design with beautifully rounded symmetrical curves. It is offered in the electric variant (solely electric or as part of hybrid systems), with options available in two heights, two lengths, and two electrical outputs.

RIVER Electric se caracterizează prin geometria sa rotundă, având curbe simetrice frumos rotunjite. Este disponibil în varianta electrică (exclusiv electric sau în sisteme hibride), oferind opțiuni pentru două înălțimi, două lungimi și două puteri electrice.

River 

Height Înălțime (H)	Length Lățime (L)	No el Nr elemente	Weight Greutate	Electric options Opțiuni electrice
mm	mm	pcs	kg	w
1000	500	9	8	300
1400	650	13	12	500



## Sera

The originality brimming with personality imbues this towel warmer with its essential, sleek lines. Drawing inspiration from the rhythmic flow of its design, SERA Electric offers a flexible and adaptable approach, capable of transforming and enhancing any bathroom space

Originalitatea plină de personalitate însuflețește acest radiator de baie cu liniile sale esențiale și elegante. Inspirându-se din fluxul ritmic al designului său, SERA Electric oferă o abordare flexibilă și adaptabilă, capabilă să transforme și să îmbunătățească orice spațiu.

Height Înălțime (H)	Length Lățime (L)	No el Nr elemente	Weight Greutate	Electric options Opțiuni electrice
mm	mm	pcs	kg	w
450	580	4	6	120
730	580	6	9	300
1010	580	8	13	300
1570	580	12	19	600



A blend of well-crafted forms, the SERENE electric towel warmer boasts exceptional versatility. With its clean and essential rectangular shape, it effortlessly combines warmth with elegance. Available in 3 heights, one length, and 3 electric outputs.

O combinație de forme drepte, radiatorul electric SERENE se mândrește cu o versatilitate excepțională. Cu forma sa rectangulară curată, îmbină cu ușurință căldura cu eleganța. Disponibil în 3 înălțimi, o lungime și 3 puteri electrice.

## Serene



Height Înălțime (H)	Length Lățime (L)	No el Nr elemente	Weight Greutate	Electric options Opțiuni electrice
mm	mm	pcs	kg	w
900	500	8	17	500
1170	500	10	22	500
1440	500	12	26	600



## Upper

Sleek and simple, the UPPER electric model redefines any setting. Its clean lines embody minimalism, capable of influencing and defining the ambiance of the bathroom, enriching its character. It is offered as a standalone electric unit and is also compatible with hybrid systems.

Elegant și simplu, modelul electric UPPER redefinește orice ambient. Liniile sale curate îmbrățișează minimalismul, având capacitatea de a influența și de a define atmosfera camerei de baie, adăugându-i personalitate. Este disponibil ca unitate electrică independentă și poate, de asemenea, să fie integrat în sistemele hibride.

Height Înălțime (H)	Length Lățime (L)	No el Nr elemente	Weight Greutate	Electric options Opțiuni electrice
mm	mm	pcs	kg	w
1200	500	8	9	300
1500	500	10	11	500
1800	500	12	13	600



UPPER QUADRO electric radiator emits a gentle warmth. With its efficient electronic thermostat, it ensures a consistently balanced room temperature. UPPER QUADRO Electric satisfies diverse tastes and needs, available in 5 heights with electric outputs up to 900 watts.

Radiatorul electric UPPER QUADRO emite o căldură delicată, menținând temperatura echilibrată datorită termostatului electronic eficient. Este disponibil în 5 înălțimi, 1 lungime de 500 mm, cu puteri electrice de până la 900 W.

## Upper Quadro



Height Înălțime (H)	Length Lățime (L)	No of Nr elemente	Weight Greutate	Electric options Opțiuni electrice
mm	mm	pcs	kg	w
780	500	11	14	500
1005	500	14	17	600
1230	500	17	21	600
1530	500	21	26	900
1830	500	25	31	900



## Vulcan NV

Discover VULCAN NV Electric, a sleek steel towel radiator for your bathroom. With options in 4 heights and a width of 565mm, it can function independently or as part of a hybrid system, adding style and warmth to your space.

Descoperă VULCAN NV Electric, un elegant radiator de baie din oțel. Disponibil în 4 înălțimi și o lățime de 565 mm, poate funcționa independent electric sau într-un sistem hibrid, adăugând stil și căldură oricarui spațiu.

Height Înălțime (H)	Length Lățime (L)	No el Nr elemente	Weight Greutate	Electric options Opțiuni electrice
mm	mm	pcs	kg	w
860	565	12	12	500
1160	565	16	17	600
1460	565	20	21	600
1760	565	24	25	900











## **TECHNICAL INFO**

## ***INFORMAȚII TEHNICE***

**Accessories, colours, valves and much more**  
***Accesorii, culori, robineti și multe altele***

**Accessories for towel rail radiators /  
Accesorii pentru radiatoare port-prosop**

**Magnetic accessories /  
Accesorii magnetice**

- 01**    
white/alb 89A21S02    black/negru 89A23S02    chrome/crom 89A27S02
- 
- 02**    
white/alb 89A11S02    black/negru 89A13S02    chrome/crom 89A17S02
- 
- 03**    
white/alb 89A31S02    chrome/crom 89A37S02
- 
- 04**    
white/alb 801#0000S1S2    white/alb 801#0001S1S2    white/alb 801#0002S1S2    white/alb 801#0003S1S2
- 
- 05**    
white/alb 89A51S40/50/60    chrome/crom 89A57S40/50/60
- 
- 06**    
white/alb 89A41S40/50/60    chrome/crom 89A47S40/50/60
- 
- 07**    
white/alb 89A81S02 89A81S00    chrome/crom 89A87S02 89A87S00
- 
- 08**    
white/alb 89A91S00    chrome/crom 89A97S00
- 
- 09**    
white/alb 89A61S00    chrome/crom 89A67S00

- 10**    
white/alb 89A21K00    black/negru 89A23K00    chrome/crom 89A27K00
- 
- 11**    
white/alb 89A11K00    black/negru 89A13K00    chrome/crom 89A17K00
- 
- 12**    
white/alb 89A31K00    chrome/crom 89A37K00
- 
- 13**    
white/alb 801#0000K1S1    white/alb 801#0001K1S1    white/alb 801#0002K1S1    white/alb 801#0003K1S1
- 
- 14**    
white/alb 89A91K00    chrome/crom 89A97K00
- 
- 15**    
white/alb 89A61K00    chrome/crom 89A67K00
- 
- 16**    
white/alb 88001002



# Premium accessories

## Accesorii premium

An exquisite radiator demands an exquisite finishing touch. RADOX provides an extensive line of designer valves, chrome plated, stainless steel and painted towel bars, towel hanger and robe hooks.

These premium accessories are a result of years of consistent development affording RADOX the artistic privilege to attire each radiator on an individual basis, according to the client's design scheme.

*Oferta RADOX nu cuprinde numai radiatoare, dar și accesorii care completează designul produsului livrat. Robineți, agățătoare și suporturi de prosoape cromate, vopsite sau din inox, sunt numai câteva dintre produsele care fac diferența prin calitate și design.*

*Accesoriile premium realizate de RADOX sunt rezultatul unei preocupări de dezvoltare constantă, în scopul de a aduce libertatea de a reinterpretă și personaliza fiecare radiator RADOX.*



Towel bar for NOVA  
Suport prosoap pentru Nova



Round robe hook  
Cârlig rotund pentru halat



Robe hook  
Cârlig pentru halat



Towel hanger | Suport pentru prosoap



Square robe hook | Cârlig pătrat pentru halat



Robe hook for VERTICA D | Cârlig halat pentru VERTICA D



Square towel bar for NOVA | Suport pătrat pentru prosoap

# Colours and finishes

## Culori și finisaje

You can find the code product for every radiator in this catalogue. As standard, for painted radiators we have put white (RAL) 9010 as standard colour. If you wish to order any other colour, just put your desired RADOX colour code instead of 9010 and you will have the right product code to be ordered.

Puteti găsi codul de produs pentru fiecare radiator din acest catalog. În mod standard, pentru radiatoarele vopsite am pus culoarea standard: alb (RAL) 9010. Dacă doriți să comandați orice altă culoare, pur și simplu puneți codul RADOX de culoare dorit în loc de 9010 și astfel veți avea codul corect al produsului în culoarea aleasă.

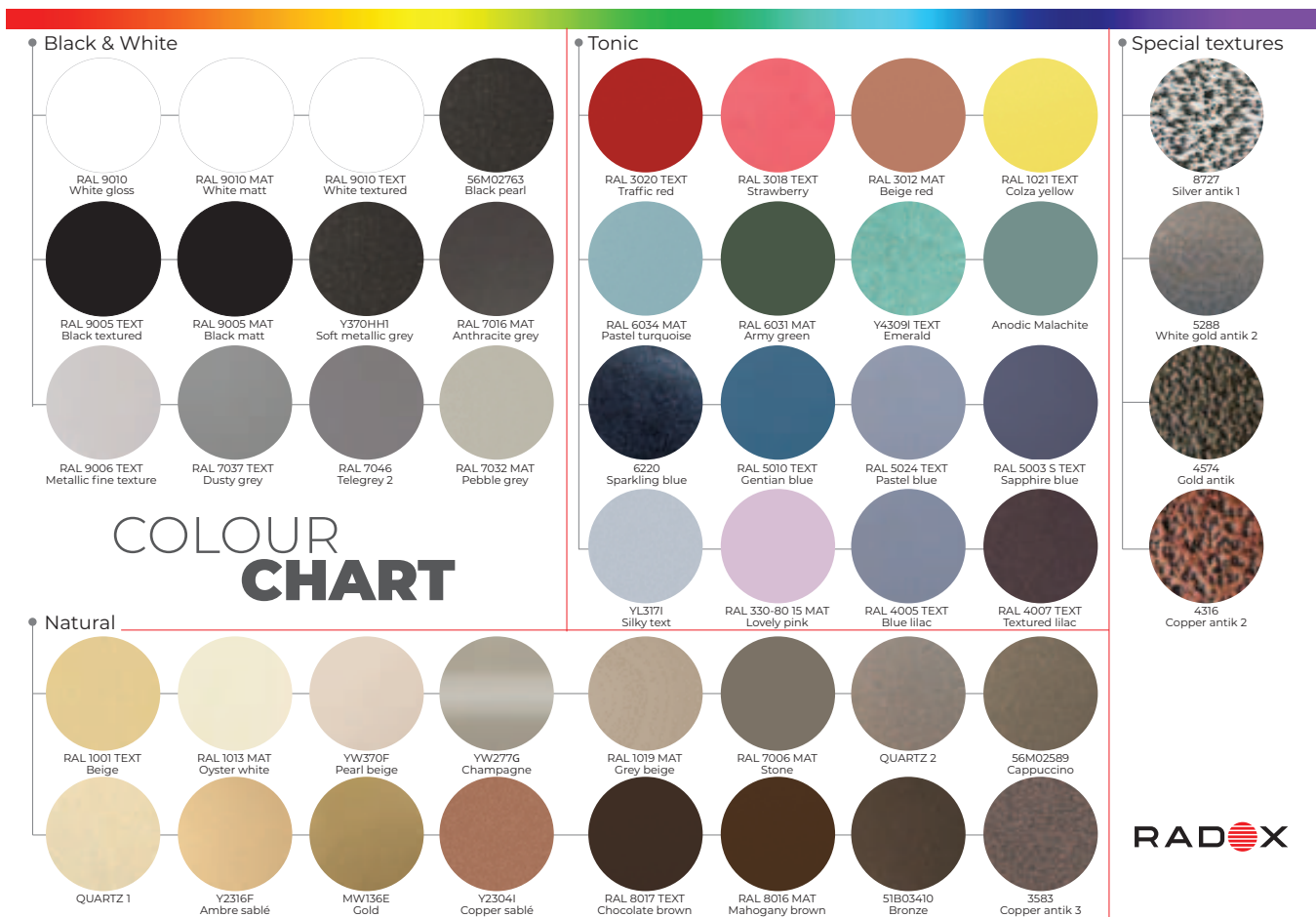

We will use the example of an ARENA Designer radiator, pag. 33 dimension 580 x 650 mm- we want to buy one in RED:  
 O să luăm ca exemplu radiatorul ARENA, pag.33 cu dimensiunea 580x650 mm - pe care dorim să îl cumpărăm în culoarea ROȘIE:

Product code from catalogue list: (RAL) 9010  
 Cod produs din tabelul din catalog: (RAL) 9010

**AR058/065V9010AC**

Wanted colour for this radiator: (RAL) 3020  
 Culoare dorita pentru acest catalog: (RAL) 3020

**AR058/065V3020AC**

This sample colour chart only represents the range of RADOX colours available. It is not representative of the actual colour finish on the radiators, as they have matt, glossy or textured finish that we cannot reproduce on this page. Please ask for a RADOX colour chart from which to confirm your selection before placing an order.

On request and subject to availability, we can provide any other RAL colour - please contact your local sales team for more details. Due to RADOX's and the painting manufacturing techniques applied, there are colour tolerances to take into consideration, as variation are possible in shade or shine.

Această mostră de culori reprezintă doar gama de culori RADOX disponibile. Nu este reprezentativă pentru finisajul real al culorilor de pe radiatoare, deoarece au finisaje mat, lucios sau texturat pe care nu le putem reproduce pe această pagină. Vă rugăm să solicitați o gamă de culori RADOX din care să confirmați selecția înainte de a trimite comanda.

La cerere și în funcție de disponibilitate, putem oferi orice altă culoare RAL - vă rugăm să contactați echipa locală de vânzări pentru mai multe detalii. Datorită tehnicilor de producție aplicate de RADOX și ale fabricanților de vopsea, există toleranțe de culoare de luat în considerare, deoarece sunt posibile variații în nuanță sau luciu.

# RADOX Painting

## Vopsirea RADOX



VESTA UNO radiator, pag. 78

CENTO 15H radiator, pag. 18

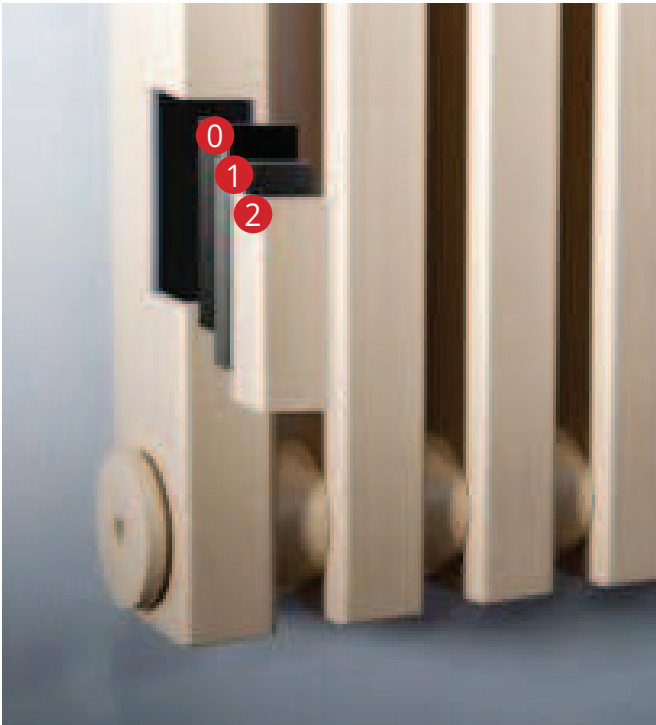

0. Raw material (steel) / Material de baza (oțel)
1. Oxide-passivation layer / Strat oxid-pasivant
2. Epoxy -polyester powder / Strat vopsea



For painted RADOX radiators, the surface preparation is essential to ensure superior corrosion resistance. By sandblasting, degreasing, phosphating, the surfaces of the radiators are cleaned and prepared so that the paint adheres perfectly to the base material and the state of the paint is an effective and durable anticorrosive.

The painting process is an ecological one, in electrostatic field, with 180 degree polymerization. The paint is purchased from the largest manufacturers in the world, such as AKZO NOBEL.

*Pentru radiatoarele RADOX vopsite, pregătirea suprafețelor este esențială în a asigura o rezistență superioară la coroziune. Prin alicare, degresare, fosfatere, suprafețele radiatoarelor sunt curățate și pregătite astfel încât vopseaua să adere perfect la materialul de bază, iar statul de vopsea să fie unul anticoroziv eficient și durabil.*

*Procedul de vopsire este unul ecologic, în câmp electrostatic, cu polimerizare la 180 grade. Vopseaua se achiziționează de la cei mai mari producători din lume, așa cum este AKZO NOBEL.*

# RADOX Chroming process

## Cromarea RADOX

0. Raw material (steel) /Material de baza (oțel)
1. Nickel semi-bright /Nichel semi-lucios
2. Nickel bright / Nichel lucios
3. Chrome bright /Crom lucios



The quality of the chrome plating process determines the level of corrosion resistance and durability of the radiator. And our finish will always have a mirror effect, without losing its shine over time. The chrome plating of RADOX radiators is of multilayer type, a superior process, made in our modern, complete automated and ecological installation.

Corrosion tests demonstrate the efficiency of our process, RADOX radiators exceeding without any trace of rust in a continuous and accelerated environment of heat and humidity (accredited laboratory) the standard 100 hours. Always concerned about the quality of our future, RADOX does not use harmful derivatives with a devastating effect on the environment - other manufacturers continue to use copper in the chromium plating process.

*Calitatea procesului de cromare determină nivelul de rezistență la coroziune și durabilitatea radiatorului. Iar finisajul va avea mereu efectul de oglindă, fără să își piardă luciul în timp. Cromarea radiatoarelor RADOX este de tip multistrat, cromare superioară realizată în instalația noastră modernă, complet automatizată și ecologică.*

*Testele de coroziune demonstrează eficiența procesului nostru, radiatoarele RADOX depășind fără nicio urmă de rugină într-un mediu continuu și accelerat de căldură și umiditate (laborator acreditat) cele 100 ore standard. Mereu preocupați de calitatea viitorului nostru, RADOX nu folosește derivați nocivi cu efecte devastatoare asupra mediului - alți producători continuă să folosească cuprul în procesul de cromare.*

SERPENTINE radiator, pag. 133



SCALA N radiator, pag. 84



# RADOX Stainless steel

## Inoxul RADOX

KAZAR radiator, pag 116 (satin finish / finisaj satinat).



Our stainless steel radiators are available in two finishes: satin or glossy. The glossy finish comes from a technological process that includes polishing the surfaces. Radiators with a satin finish are obtained by abrasive grinding. All made from 100% recyclable, eco-friendly 304 marine grade stainless, our radiators are some of the most durable products on the market.

*Radiatoarele din oțel inoxidabil sunt disponibile în două finisaje: satinat sau lucios. Finisajul lucios se realizează în urma unui proces tehnologic ce include lustruirea suprafețelor. Radiatoarele cu finisaj satinat se obțin prin șlefuire abrazivă. Sunt fabricate din oțel inoxidabil 100% reciclabil, ecologic, de calitate superioară 304, fiind unele dintre cele mai durabile produse de pe piață.*

BROC radiator, pag. 36 (glossy finish / finisaj lucios)



UPPER radiator, pag 138 (glossy finish / finisaj lucios).



# Valves Robineți



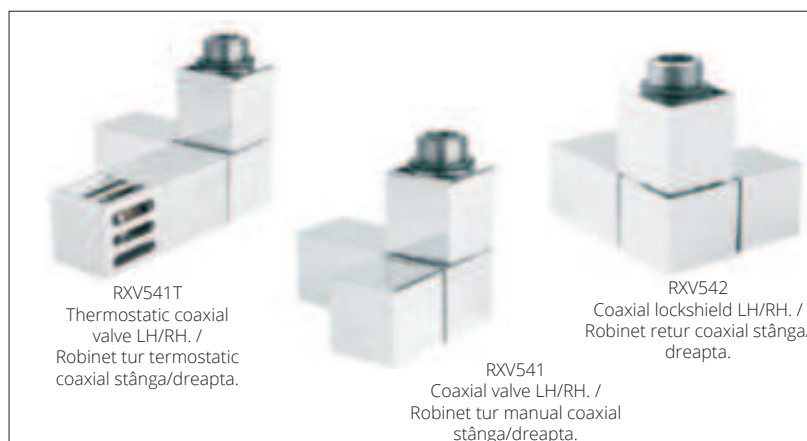
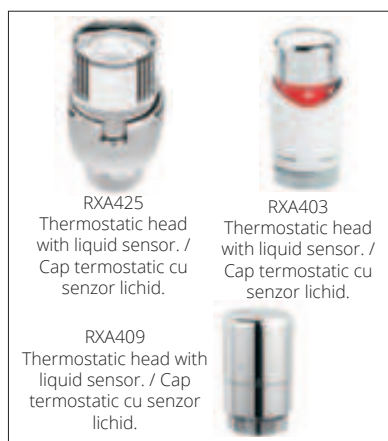
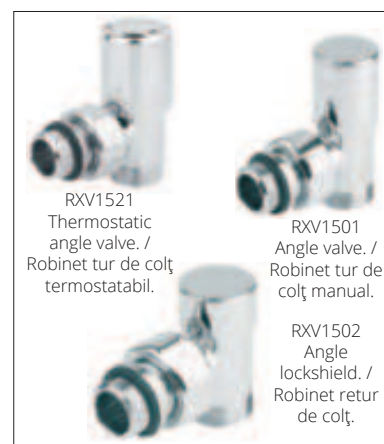
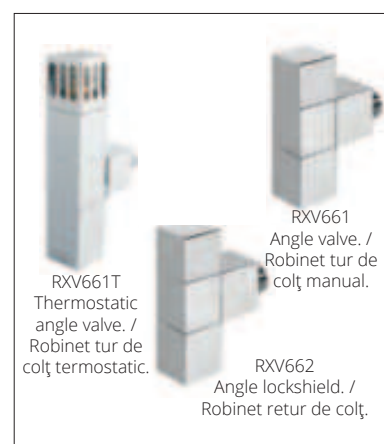
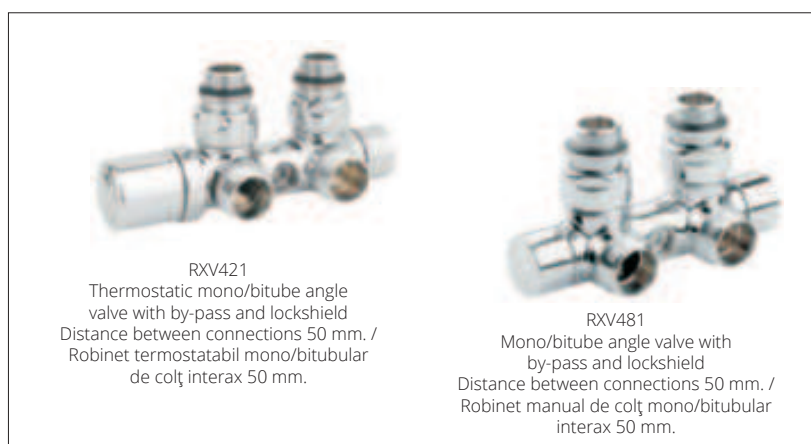
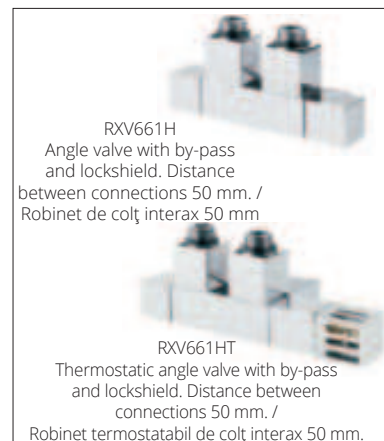

Valves are not included and must be ordered separately, if required. / Robineții nu sunt incluși și trebuie comandați separat, la cerere.



Class I Electric option 01 with mechanical thermostat  
*Clasa I Variantă electrică 01 cu termostat mecanic*



Class I Thermostatic Electric option 02 with led display  
*Clasa I Variantă electrică 02 cu termostat și display led*

Wireless programmable controller T1 compatible with  
Thermostatic Electric option 02  
*Controler programabil wireless T1 compatibil  
cu variantă electrică 02*



Class I Electric option 03 horizontal insalling /  
*Clasa I Variantă electrică 03 pentru instalare orizontală*



# Electrical radiators

## Radiatoare electrice

Electric Radiators are an excellent alternative to central heating and fortunately most of our radiators (50%) can be electric. Your home heating needs can be effectively provided for with a designer RADOX radiator and a simple electrical connection. Our outputs are according to the radiator size, usually 300, 500, 600 and 900 watts, but we can offer higher outputs.

*Foarte ușor de folosit, radiatoarele electrice reprezintă o bună alternativă la încălzirea centrală și o mare parte din radiatoarele noastre (50%) pot fi și electrice. Doar cu o legătură electrică și un elegant radiator RADOX, puteți avea un sistem complet de încălzire în orice încăpere. Puterile sunt funcție de modelul radiatorului, de obicei de 300, 500, 600 și 900 watt, însă putem oferi și puteri mai mari.*

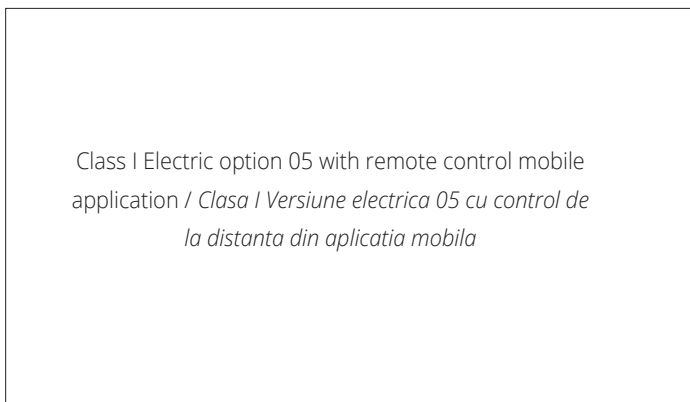

# Mixed radiators

## Radiatoare mixte

In order to address the diverse needs of our clients across the globe and their varying climates, RADOX offers radiators capable of utilizing hydronic, electric and hybrid heating systems (hydronic and electric combination). This system essentially is an efficient method of connecting the heater to a boiler (or other heat source) in the winter while during cooler seasons when the boiler remains off, the heater utilizes electricity as its energy source, thus ensuring a warm room on a cold spring or autumn day. Our hybrid radiators are packed with a stopper for the water outlet and a valve for the water entry point. Additionally, each radiator comes with wall mounts, air vents and a Class I or II electrical kit. Valves and fittings need to be specified upon order.

*Pentru a satisface nevoile și preferințele specifice ale clienților noștri din întreaga lume, RADOX oferă radiatoare care pot funcționa hidraulic, electric și mixt (hidraulic și electric). Acest sistem este o metodă flexibilă și eficientă de conectare la o centrală termică (sau altă sursă de căldură) în timpul iernii, în timp ce, în anotimpurile răcoroase atunci când centrala termică este oprită, pentru încălzire se folosește electricitatea ca sursă de energie, asigurându-se astfel o cameră caldă într-o zi rece de primăvară sau toamnă.*

*Radiatoarele noastre mixte sunt asamblate cu un teu (T-piece) care face posibilă funcționarea mixtă. În plus, fiecare radiator mixt este livrat cu console de prindere pe perete, aerisitor și un kit electric clasa I sau II. Robineții și alte accesorii trebuie solicitați separat.*



## Radox Electric & Mixt Radiators:

### **DESIGNER RADIATORS:**

ARENA, CIRCLE, FAN, NOVA, NOVA GLASS, NOVA PAN 45, RC CONVECTOR

### **STANDARD TOWEL RADIATORS:**

CELSIUS, SCALA N, SUNIT P100

### **DESIGNER TOWEL RAIL RADIATORS:**

APOLLO, APOLLO FLEXI, ARAMIS, ARIUS, AZTEC, BOKA, BREAK Q, DOHA, DORA 70, EMPIRE, LINX, QUEBIS, RIVER, SERA, SERENE, SUNNY FLEXI, UPPER, UPPER QUADRO, VULCAN NV, VULCAN NV FLEXI

We are at your disposal for any further information regarding the electrical outputs, product dimensions and mounting solutions. /

*Vă stăm la dispoziție cu detalii privind puterile, dimensiunile și soluțiile de montaj disponibile.*

# Mounting kits

## Kit console de prindere

All RADOX designer radiators and towel rails collection are supplied complete with brackets and wall fixings. Our collection of radiator brackets allow you to install your RADOX radiator easily creating the right look to suit the style of your room. Fittings and mounting kits come in a variety of finishes to complement RADOX's chrome, coloured or stainless steel towel rails and designer radiators.

We provide specifically designed blanking plugs and flat covers in chrome or white for our designer radiators and on request for the towel rails radiators.

Toate radiatoarele RADOX ornamentale și port-prosoap sunt furnizate cu kit complet de console de prindere în perete. Gama noastră de console vă permite să instalați cu ușurință orice radiator RADOX completând interiorul camerei dumneavoastră. Accesoriile și kiturile de montaj vin într-o varietate de finisaje pentru a completa radiatoarele RADOX cromate, inox sau vopsite în diferite culori RAL.

Oferim dopuri și aerisitoare plate cu capace de protecție cromate sau vopsite alb pentru radiatoarele noastre ornamentale și, la cerere, pentru radiatoare port-prosoap.



K01-K14 & K04-K11

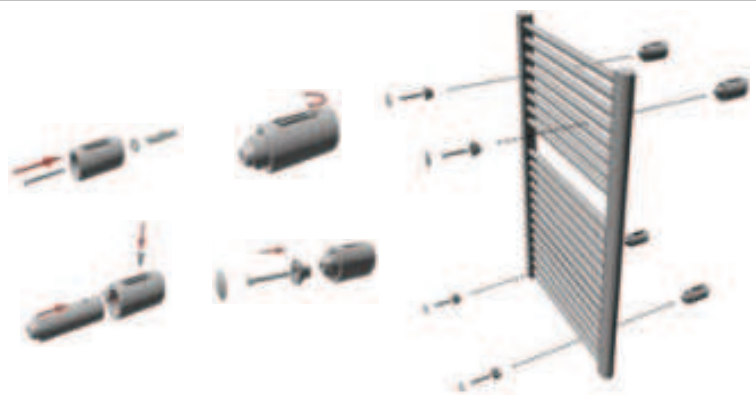

K07



K08

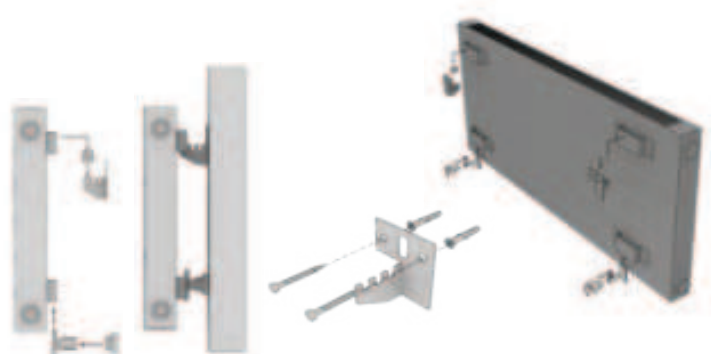



K02



K13



K03



K24



K06



K25



K12



K26





K15



K22



K23



K19





K17

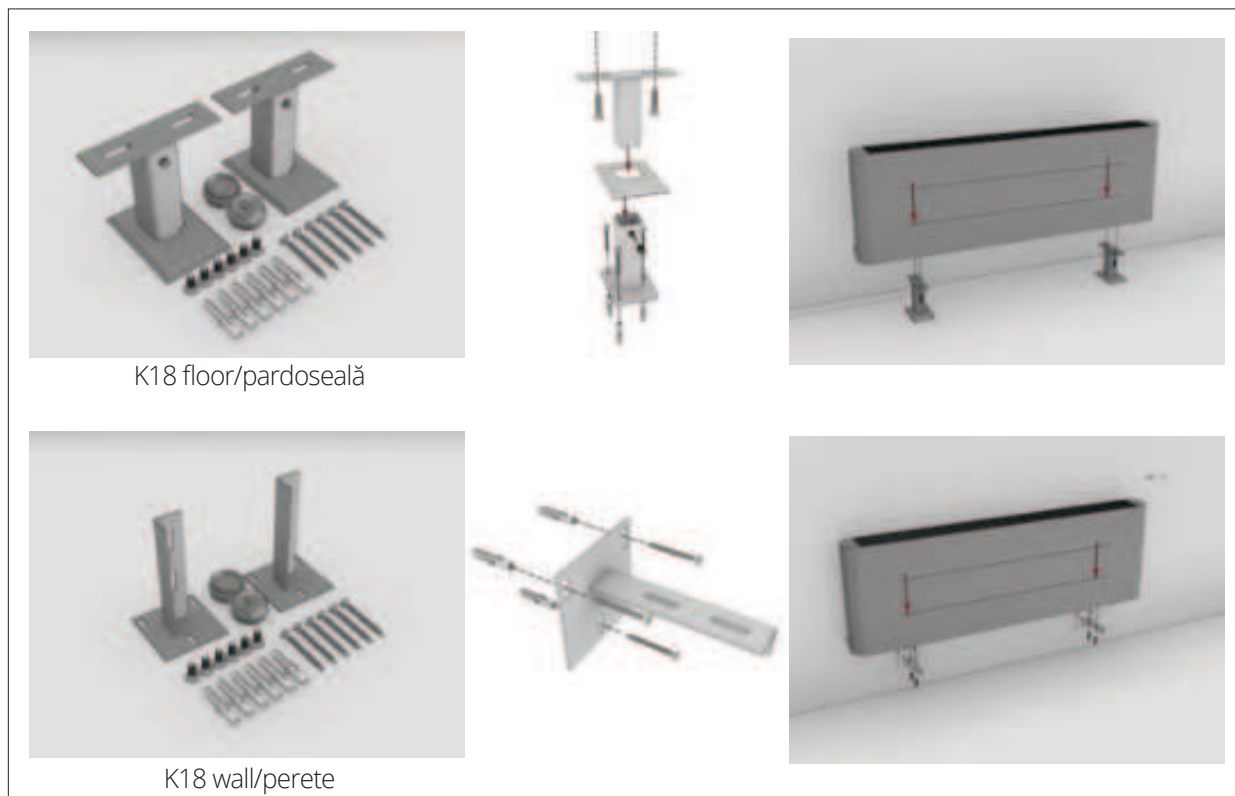

K18 floor/pardoseală

K18 wall/perete



K05

All RADOX radiators are equipped with brackets and wall fixings suitable only for concrete or solid brick walls. For mounting on other types of structure (plasterboard, hollow brick walls, AAC etc.), we recommend you to consult a qualified construction expert.

*Toate radiatoarele RADOX sunt echipate cu kit complet de prindere în pereți de beton sau cărămidă plină. Pentru montajul pe alte tipuri de structură (pereți din rigips, cărămidă cu goluri, BCA etc), vă recomandăm să vă consultați cu un specialist în construcții.*

## DISCLAIMER

The technical communications only have explanatory value. RADOX reserves its right to make modifications at any time for technical or commercial reasons, without prior notice, to the items described in the documentation mentioned above. The information included in our technical documentation does not exempt the user from following carefully the existing national regulations and norms on good workmanship.

The information about certifications, approvals and homologations featured on the catalogue it is subject to continuous update and could refer to certain product sizes only. In case of lack of or unclear information please do get in touch with your local sales team.

*Datele tehnice au doar o valoare explicativă. RADOX își rezervă dreptul de a modifica informațiile în orice moment din motive tehnice sau comerciale, fără notificare prealabilă. Informațiile incluse în documentația noastră tehnică nu scutesc utilizatorul de respectarea cu atenție a reglementărilor și normelor naționale existente în domeniul construcțiilor și al instalațiilor.*

*Informațiile despre certificările, aprobările și omologările prezentate în catalog sunt supuse unei actualizări continue și se pot referi numai la anumite dimensiuni ale produselor. Dacă lipsesc informații sau acestea sunt neclare, vă rugăm să luați legătura cu echipa locală de vânzări.*



Thanks to:

3D Artist: Daniel RĂDULESCU ([www.danielradulescu.ro](http://www.danielradulescu.ro))  
George DEAC ([www.impromedia.ro](http://www.impromedia.ro))  
Printing house: SILKAT ([www.silkatprint.ro](http://www.silkatprint.ro))

# Conditions & terms

The information contained in catalogues, fliers and other marketing documents are always free of obligation for the SUPPLIER (RADOX). We reserve the right to modify the technical procedures concerning the individual construction, form, materials etc. Due to printing processes and manufacturing tolerances, the colour of finished radiators may vary slightly from those shown in the brochure and a standard RAL colour chart. **Taking into consideration our dimensional tolerances, we recommend that pipe work is not altered or adjusted until your radiator or towel rail is delivered.**

**SPECIAL AND CUSTOM-MADE VERSIONS.** With a view to satisfying the market needs, RADOX proposes a unique range of customized solutions which can be defined with the CLIENT. Furthermore, the technical department personnel is always at the CLIENT's disposal to analyse, evaluate and provide estimates for customized shapes, connectors or other specific needs of the CLIENT whenever feasible.

**Hydraulic connections.** Most RADOX's radiators have 4 side connections of ½", so they can be easily installed in any heating system. As some radiators of specific size or unique design might have specific connection requirements, you must consult a heating engineer or a plumber if the heating system has not been build yet. In this case, prior to ordering radiators, you must get information about the planned location and the type of connection you need.

**ORDERS.** The radiators are delivered in compliance with SUPPLIER's order confirmation. Stock models have a delivery term of 7-10 days. If you require non stock products, these have a delivery term of 5-6 weeks. However, the delivery deadline is always indicated in the SUPPLIER's confirmation. Any modification of the orders are not granted if the production has already begun. Any change of order can involve further costs and a delay of the delivery. The cancellation or any change of an order is subject to a written agreement with the SUPPLIER. Any costs deriving from the cancellation will be charged to the CLIENT. Any case of force majeure (wars, natural calamities,

lack of raw materials, modification of export or import terms and conditions, production limitation, strikes, disorders, etc) release the SUPPLIER of any delivery term previously fixed.

**THE ORIGIN OF DELIVERY.** The SUPPLIER's products shall be delivered from our factory in Bucharest (Romania) - Bd. Timisoara No. 80, unless specified otherwise.

**DISPATCH.** Radox products are delivered EX-Works Bucharest.

**CLAIMS.** All functional defects which may occur within 10 years for the steel radiators and 20 years for the stainless steel ones from the invoice date must be reported after a maximum of 7 days from the discovery of such faults. All defects inherent in the nature of the job create an obligation for the SUPPLIER to simply replace the certain faulty products, without having to give compensation for any other potential damages. The company does not accept any return of goods unless authorised in advance, excluding the situation mentioned in point above. Any goods returned to us without our authorisation will not be accepted, thus obliging the CLIENT to take them back.

**GUARANTEE.** We offer a 10-year guarantee for our steel radiators and towel rails and 20 years for the stainless steel products against any leakages and 5 years for other defects 2 years guarantee for all electrical parts. The guarantee commences from the date of the SUPPLIER's invoicing. To benefit from this guarantee, our products must have been installed by qualified professionals, in accordance with our instructions and regulation. The guarantee does not cover the CLIENT under the following circumstances: improper installation; abnormal utilisation of products; in case the products were frozen or suffered a shock; the CLIENT used inadequate substances or products either on the interior or exterior of RADOX goods; the bad water quality caused damage. Our radiators are guaranteed with the following reserves:

- The radiator must be stored in good condition and protected from bad weather before being installed;
- Installation must be made according to the rules;
- The water used to feed the heating circuit must be within standard limits 12° Fr;
- The circuit must be free of any metal residues, calamine, grease and there must be no gas present;
- Do not leave the radiator without water, even in summer months;
- Do not use sea water to fill the radiator;
- The water PH must have a value between 6.5 and 8;
- **Do not use the radiators and/or the installation system for any other domestic purpose but heating;**
- If a corrosion inhibitor is used, this must be compatible with all the materials contained in the heating radiators;
- Transforming our radiator or modifying its surface treatment eliminate the CLIENT's guarantee rights;
- The charges for installing and uninstalling the products are not covered by the guarantee. We are not liable for any damages cause by depriving the CLIENT of the radiators during their repair or replacement period.

**LIMITATIONS OF RESPONSIBILITY.** In what concerns our responsibilities related to our products, we do not accept liabilities that are greater than the guarantee cover described previously. A client should inform us without delay of any concrete compensation which may be requested of us, such that we can measure our responsibility given the situation. The CLIENT does not have the right to change the terms of responsibility or guarantee that we have offered. The general conditions are subject to Romanian law.

**Products for OEMs** - Thanks to our design know-how and the fact that we make all of our products internally, we're able to supply radiators for OEM customers that need a tailor-made product. Our production of radiators for OEM customers is vast, with a wide assortment. Apart from the various degrees of customization of existing products, we're also able to evaluate, design and engineer, together with the customer, any type of radiators compatible with our production process.

All information presented is indicative and RADOX reserves the right to modify it without notice.



# Condiții generale de vânzare

Datele cuprinse în catalog, pliante, broșuri sau alte materiale publicitare au caracter informativ. RADOX (FURNIZORUL) are dreptul de a modifica fără notificare procedurile tehnice în ceea ce privește construcția, forma, materialele produselor sale. Având în vedere procesul de tipărire și toleranțele de fabricație, culoarea radiatorului poate fi diferită de cea prezentată în broșură sau în schema de culori RAL. **De asemenea, ținând cont de toleranțele dimensionale de fabricație, recomandăm ca instalația termică să nu fie finalizată înainte de a primi radiatorul.**

**PRODUSE SPECIALE ȘI FABRICATE LA COMANDĂ.** RADOX propune și o gamă de soluții personalizate. Mai mult, personalul departamentului tehnic este tot timpul la dispoziția CLIENTULUI pentru a analiza, evalua, oferi soluții sau pentru orice alte cerințe speciale.

**CONEXIUNI HIDRAULICE.** Cele mai multe radiatoare RADOX au 4 conexiuni laterale de ½", astfel încât acestea să poată fi ușor de instalat în orice sistem de încălzire. Deoarece unele radiatoare au dimensiuni specifice sau un design unic, acestea ar putea avea cerințe specifice de conectare – în acest caz, trebuie să consultați un inginer de instalații termice sau un instalator, în cazul în care sistemul de încălzire nu a fost încă construit. În acest caz, înainte de a comanda radiatoare, trebuie să știți care este locația planificată și tipul de conexiune de care aveți nevoie.

**COMENZI.** Radiatoarele sunt livrate în condițiile specificate în formularul de confirmare a comenzii. Modelele ce se află în stoc au un termen de livrare de 7-10 zile. Pentru produse care nu se afla în stoc, termenul de livrare este de 5 - 6 săptămâni de la data confirmării comenzii de către client. Cu toate acestea, termenul de livrare este specificat în momentul confirmării comenzii. Nu este permisă modificarea comenzilor după ce procesul de producție a început. Modificarea comenzii presupune costuri suplimentare și creșterea timpului de livrare. Anularea sau modificarea unei comenzi se face în baza unui acord scris cu FURNIZORUL. Costurile ce derivă din anularea unei comenzi vor fi suportate de către

CLIENT. În caz de forță majoră, FURNIZORUL poate modifica termenul de livrare stabilit anterior.

**ORIGINEA PRODUSELOR.** Produsele RADOX sunt livrate din fabrica noastră din București (România) – Bd. Timișoara, Nr. 80, sector 6, cu excepția cazurilor în care este specificată altă origine a produselor.

**LIVRAREA.** Produsele RADOX sunt livrate în condiții Ex-Works București.

**RECLAMAȚII.** Toate defectele de fabricație care apar în perioada de garanție trebuie raportate în maxim 7 zile de la descoperirea defectului. FURNIZORUL este obligat să remedieze/înlocuiască produsul în cazul unor defecte de fabricație, fără a fi necesară plata daunelor. RADOX nu acceptă bunuri returnate fără o autorizare în prealabil, excluzând situațiile menționate anterior. Toate bunurile returnate fără autorizația noastră nu vor fi acceptate, și vor fi trimise înapoi clientului.

**GARANȚIA.** Noi oferim următoarea garanție pentru problemele cauzate de defecte de fabricație: 10 ani în cazul pierderilor de apă pentru radiatoarele de oțel și 20 de ani pentru produsele din oțel inoxidabil; 5 ani garanție pentru alte probleme de fabricație și 2 ani garanție pentru părțile electrice. Garanția este valabilă în condițiile în care radiatoarele sunt folosite în mod corespunzător, într-un sistem de încălzire centrală cu apă caldă. Perioada de garanție începe cu data facturării produsului. Pentru a beneficia de garanție, produsele noastre trebuie instalate de către personal calificat în acord cu instrucțiunile și reglementările din domeniu. Garanția nu mai este valabilă în următoarele situații: dacă clientul nu furnizează date complete privind eticheta (poziționată pe spatele radiatorului) care evidențiază săptămâna și anul de producție, fotografii, documentație scrisă privind tipul defectului; instalare defectuoasă, folosirea neadecvată a produselor, în cazul în care produsele au înghețat sau au suferit șocuri, clientul a folosit substanțe sau produse necorespunzătoare pe

suprafața exterioară sau în interiorul produselor RADOX; calitatea inferioară a apei a deteriorat produsul. Recomandările privind utilizarea radiatoarelor noastre sunt:

- înainte de a fi instalat, radiatorul trebuie depozitat în condiții bune și protejat de intemperii;
- radiatorul trebuie instalat conform normelor de instalare;
- apa folosită pentru a alimenta circuitul de încălzire trebuie să fie în limitele standard de 12° Fr;
- circuitul nu trebuie să conțină reziduuri metalice, calamina, grăsimi sau gaz;
- nu lasați radiatorul fără apă, chiar și pe timpul verii;
- nu folosiți apa de mare pentru a umple radiatorul;
- PH-ul apei trebuie să aibă o valoare cuprinsă între 6.5 și 8;
- **nu folosiți și/sau instalați radiatorul în alt scop decât încălzirea spațiilor;**
- dacă se folosește un inhibitor de coroziune, acesta trebuie să fie compatibil cu toate materialele pe care radiatorul le conține;
- modificare radiatorului sau a suprafeței acestuia duce la pierderea garanției;
- garanția nu acoperă costurile instalării sau dezinstalării radiatorului; în perioade de reparații sau înlocuire a radiatorului nu ne asumăm responsabilitatea pentru daunele create CLIENTULUI.

**LIMITĂRI ALE RESPONSABILITĂȚII.** Nu ne asumăm responsabilități mai mari decât cele acoperite prin garanție. Clientul trebuie să ne informeze din timp cu privire la orice compensație materială ce ne este solicitată astfel încât să ne permită evaluarea situației și asumarea răspunderii pentru daunele create dacă este cazul. Clientul nu are dreptul de a modifica termenii și condițiile noastre. Condițiile generale fac subiectul legii române.

**Produse OEM** - Datorită know-how-ului nostru de proiectare și a faptului că noi facem toate produsele în fabricile proprii, suntem capabili să furnizăm radiatoare pentru clienții OEM care au nevoie de un produs personalizat. Producția noastră de radiatoare pentru clienții OEM este vastă, cu un sortiment larg. În afară de diversele niveluri de personalizare a produselor existente, putem analiza și proiecta, împreună cu clientul, orice tip de radiatoare compatibile cu procesul nostru de producție.

Toate informațiile prezentate sunt orientative și RADOX își rezervă dreptul de a face modificări fără o notificare prealabilă.





# RADOX



Bucharest, Romania  
Blvd Timisoara 80  
6 th district, 061334

Tel.: 0040 21 4440741  
Fax: 0040 21 4440742

[www.radox-radiators.com](http://www.radox-radiators.com)  
[export@radox.ro](mailto:export@radox.ro)

[www.radox.ro](http://www.radox.ro)  
[vanzari@radox.ro](mailto:vanzari@radox.ro)

