

EVODENS PRO AMC

WALL-HUNG GAS CONDENSING BOILERS



AMC
45, 65, 90 or 115



AMC (ALL MODELS)
fitted in cascade

- **AMC 45**

9.1 to 42.4 kW, for heating only

- **AMC 65**

13.5 to 65.0 kW, for heating only

- **AMC 90**

15.8 to 89.5 kW, for heating only

- **AMC 115**

21.2 to 109.7 kW, for heating only



Heating and domestic hot water using an independent tank



All natural gas
Propane



Condensing

OPERATING CONDITIONS

Max. working pressure: 4 bar

Max. working temperature: 90 °C

Safety thermostat: 110 °C

Power supply: 230 V/50 Hz

International Protection marking: IP X4D

homologations

B23P - B33 - C13(x) - C33(x) - C93(x) - C63(x) - C53

gas category

II2ESi3B/P

NOx class: 6

EVODENS PRO are delivered with a choice of one of the following two control panels:

- **DIEMATIC EVOLUTION:** according to the options connected, this enables command and control of up to 3 heating circuits according to the outdoor temperature + 1 DHW circuit. It also allows optimised management of combined systems and the control of 2 to 8 boilers in cascade configuration (see page 5) when combined with boilers with the IniControl 2 panel (or DIEMATIC EVOLUTION).
- **IniControl 2:** for operation via a 0-10V input; supplied as standard with this panel. It is used as a slave boiler as part of an installation in cascade configuration, actuated by a boiler equipped with the DIEMATIC EVOLUTION panel or in a cascade system where each boiler is controlled via a 0-10V input.

Different air/flue gas connection configurations are possible; we offer connection solutions using a horizontal or vertical forced flue, on a chimney or bi-flow.

Complete hydraulic systems for connection of a cascade of 2 to 8 boilers are also available; versions with 2 to 4 boilers are presented in this brochure.



identification no.:
0063CS3928

PRESENTATION OF THE RANGE

AMC (ALL MODELS)

STRENGTHS

EASY MAINTENANCE

- full access to the boiler from the front

COMPACT

- Dimensions: width 500 mm, depth 500 mm
- Max weight 68 kg

CASCADE (2 TO 8 BOILERS)

- With connection kit and mounting bracket

FLUE GAS SYSTEM

- B23P, C13(x), C33(x), C93(x), C63(x), C53
- Integrated cascade flue gas valve

PERFORMANCE

- 45 to 115 kW output
- Condensing
- 108.0 to 110.6% efficiency
- NOx class 6
- Flow rate proportional to output
- ΔT 40 K with AMC 45 – 65 – 90 and ΔT 35 K with AMC 115

BURNER MODULATION

- Range from 20 to 100 %

MODBUS COMMUNICATION

HYDRAULIC CONNECTION

- Identical to MCA
- Can be replaced without the need to modify the pipework

BURNER

- Stainless steel premix



NOISE POWER LEVEL

- Less than 61 dB(A)

MODELS AVAILABLE

PROJECT

up to

A



AMC_Q000B

For heating only option to connect a domestic hot water tank using a connection kit with loading pump)

CONTROL PANEL	EVODENS PRO MODEL	NOMINAL OUTPUT RANGE		ENERGY CLASS	REF. NO.
		at 50/30 °C (kW)	at 80/60 °C (kW)		
DIEMATIC EVOLUTION	AMC 45 EVOLUTION	9.1 to 42.4	8.0 to 40.0	A	7699475
	AMC 65 EVOLUTION	13.5 to 65.0	12.0 to 61.5	A	7699476
	AMC 90 EVOLUTION	15.8 to 89.5	14.1 to 84.2	—	7699477
	AMC 115 EVOLUTION	21.2 to 109.7	18.9 to 103.9	—	7699478
INICONTROL 2	AMC 45 IniControl 2	9.1 to 42.4	8.0 to 40.0	A	7684462
	AMC 65 IniControl 2	13.5 to 65.0	12.0 to 61.5	A	7684586
	AMC 90 IniControl 2	15.8 to 89.5	14.1 to 84.2	—	7684587
	AMC 115 IniControl 2	21.2 to 109.7	18.9 to 103.9	—	7684588

TECHNICAL SPECIFICATIONS FOR BOILERS

FOR AMC (ALL MODELS)

DESCRIPTION

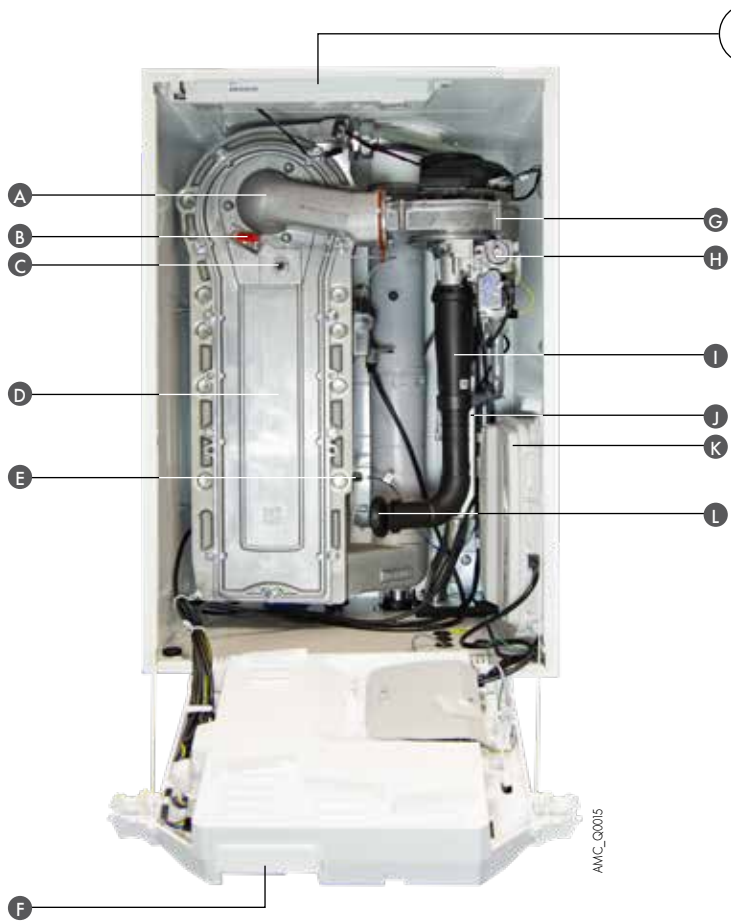

DETAIL OF THE BOILER INTERNAL LIGHTING



AMC_Q0011

- A Gas line with non-return valve
- B Ionisation/ignition electrode
- C Flame inspection glass
- D Packaged heat exchanger made from aluminium/silicium
- E Return temperature sensor
- F Control panel:
 - DIEMATIC EVOLUTION: see p. 7
 - IniControl 2: see p. 9
- G Fan
- H Gas safety unit
- I Premix venturi
- J Vent bottle
- K Box containing the PCBs
- L Intake silencer

VIEW OF THE BOILER FROM UNDERNEATH



- A Cable routing for the heating pump connection
- B Power connection cable
- C Heating flow and return
- D Location for siphon connection
- E Gas inlet

TECHNICAL SPECIFICATIONS

FOR AMC (ALL MODELS)

TECHNICAL SPECIFICATIONS AND PERFORMANCES AS PER RT 2012

BOILER DATA

Generator type: heating only
Boiler type: condensing
NOx class: 6
Burner: premix burner

Energy used: natural gas or propane
Combustion evacuation: chimney or sealed
"CE certificate" ref.: CE 0063CS3928

Operating temperature:
• Max.: 85 °C
• Min.: 25 °C

MODEL		AMC	45	65	90	115
Useful output	• nominal determined at Qnom ^{III}	kW	40.8	61.5	84.2	103.9
	• intermediate at 30% Qnom ^{III}	kW	13.7	20.5	27.9	34.7
Useful output at 50/30 °C Pn (heating mode)		kW	42.4	65	89.5	109.7
Efficiency in % LCV at ...% load Pn and water temp...°C	• 100% Pn at av. temp. 70 °C	%	99.1	99.2	97.9	97.1
	• 30% Pn at return temp. 30 °C	%	110.6	110.4	108.1	108.0
Seasonal energy efficiency: Product Etas (without control system)		%	94	94	-	-
Seasonal energy efficiency: AMC EVOLUTION Etas (with control system)		%	96	96	-	-
Useful efficiency at ...% of the nominal heat output	• at 30 % Eta 1	%	-	-	97.4	97.3
	• at 100% Eta 4	%	-	-	88.2	87.5
Nominal water flow rate at Pn and ΔT = 20 K		m ³ /h	1.72	2.62	3.62	4.60
Stand by losses at Δt = 30 K		W	101	110	123	123
Electrical output of auxiliaries at Qnom ^{III}		W	79	89	114	182
Electrical output of auxiliaries in standby		W	6	7	7	6
Useful output at 50/30°C min./max.		kW	9.1-42.4	13.5-65.0	15.8-89.5	21.2-109.7
Useful output at 80/60°C min./max.		kW	8-40.8	12-61.5	14.1-84.2	18.9-103.9
Flue gas mass flow rate min./max.		kg/h	14/69	21/104	28/138	36/178
Pressure available at boiler outlet		Pa	150	100	160	220
Water content		l	4.3	6.4	9.4	9.4
Minimum water flow rate required if operating above 75 °C		m ³ /h	0.195	0.290	0.340	0.455
Water side pressure drop at ΔT = 20 K		mbar	114	163	153	250
Max. gas flow rate (15 °C-1013 mbar)	• natural gas H/L	m ³ /h	4.4/5.1	6.6/7.6	9.1/10.6	11.3/13.6
	• propane	m ³ /h	1.7	2.5	3.5	4.4
Weight (empty)		kg	53	60	67	68

III Qnom = nominal heat output

MAIN DIMENSIONS (IN MM AND INCHES)

AMC 45, 65, 90, 115

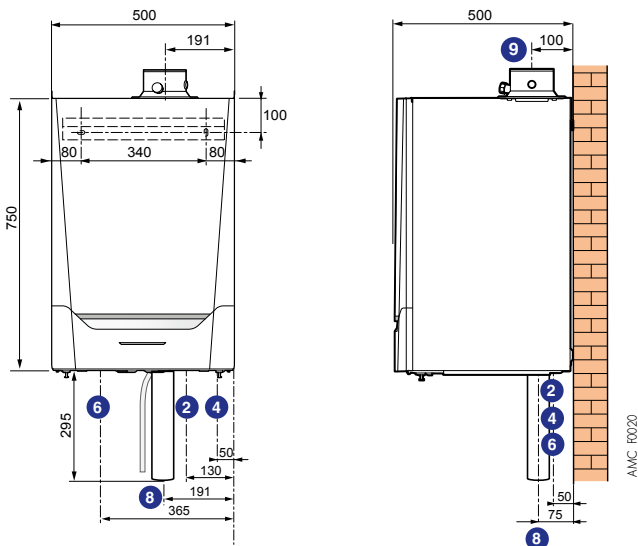

KEY

- ② Heating flow R 1" 1/4
- ④ Gas inlet R 3/4"
- ⑥ Heating return R 1" 1/4
- ⑧ Condensate discharge (siphon and Ø 25 mm ribbed flow hose for outside use supplied)
- ⑨ Air-gas connection:
 - Ø 80/125 mm for AMC 45
 - Ø 100/150 mm for AMC 65, 90 and 115



CONTROL PANELS

FOR AMC (ALL MODELS)

The control panel is selected based on the installation to be created:

INSTALLATION WITH ONLY 1 BOILER







2 TYPES OF PANEL ARE POSSIBLE

 or
 
 IniControl 2

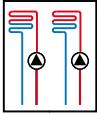
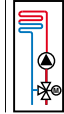
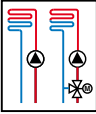
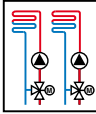
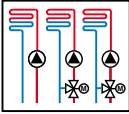
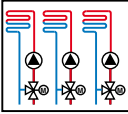
- For installations with 0-10 V control cabinet in a boiler room



 DIEMATIC Evolution

- For zone controlling:

					
2 x direct	valve	direct + 1 valve	2 x valve	direct + 2 x with valve	3 x with valve
OPTIONS as standard	1 flow sensor AD199	1 flow sensor AD199	2 flow sensors AD199	1 flow sensor D199 + 1 PCB AD249	2 flow sensors AD199 + 1 PCB AD249
					

CASCADE INSTALLATION OF 2 TO 8 BOILERS

WITH INICONTROL 2 CONTROL PANELS

 All the boilers will be connected via a 0-10 V input to an external controller which will manage all the secondary circuits.







 0-10 V

 AMC 45/115 IniControl 2 AMC 45/115 IniControl 2 AMC 45/115 IniControl 2

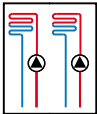
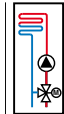
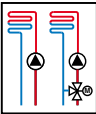
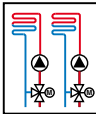
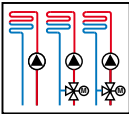
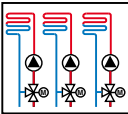
WITH DIEMATIC EVOLUTION CONTROL PANEL FOR THE 1ST BOILER IN THE CASCADE (MASTER BOILER) AND 1 INICONTROL 2 PANEL FOR EACH OF THE SLAVE BOILERS



 DIEMATIC Evolution

- For zone controlling:

					
2 x direct	mixing	direct + 1 mixing	2 x mixing	direct + 2 x with mixing	3 x with mixing
OPTIONS as standard	1 flow sensor AD199	1 flow sensor AD199	2 flow sensors AD199	1 flow sensor D199 + 1 PCB AD249	2 flow sensors AD199 + 1 PCB AD249
					

 DIEMATIC Evolution

 • No additional secondary circuit may be connected to the IniControl 2 panel

 IniControl 2

Boiler 1
 • AMC 45/115 DIEMATIC EVOLUTION (master)
BUS
 • (S-BUS cable - Package AD308/AD309/AD310)

Boilers 2 to 8
 • AMC 45/115 IniControl 2 (slaves)

CONTROL PANELS

FOR AMC (ALL MODELS)

CASCADE INSTALLATION OF 2 TO 8 BOILERS (CONTINUED)

To connect more than 3 heating circuits to a cascade installation, one of the MCA 45/115 IniControl 2 boilers in the cascade must be replaced with one (or several, depending on the number of additional circuits to be managed) MCA 45/115 DIEMATIC EVOLUTION boiler(s) (see example in the hydraulic diagram on page 19).

WITH A DIEMATIC EVOLUTION CONTROL PANEL FOR THE FIRST BOILER IN THE CASCADE (MASTER BOILER) AND 1 OR SEVERAL DIEMATIC EVOLUTION PANELS FOR EACH OF THE SLAVE BOILERS

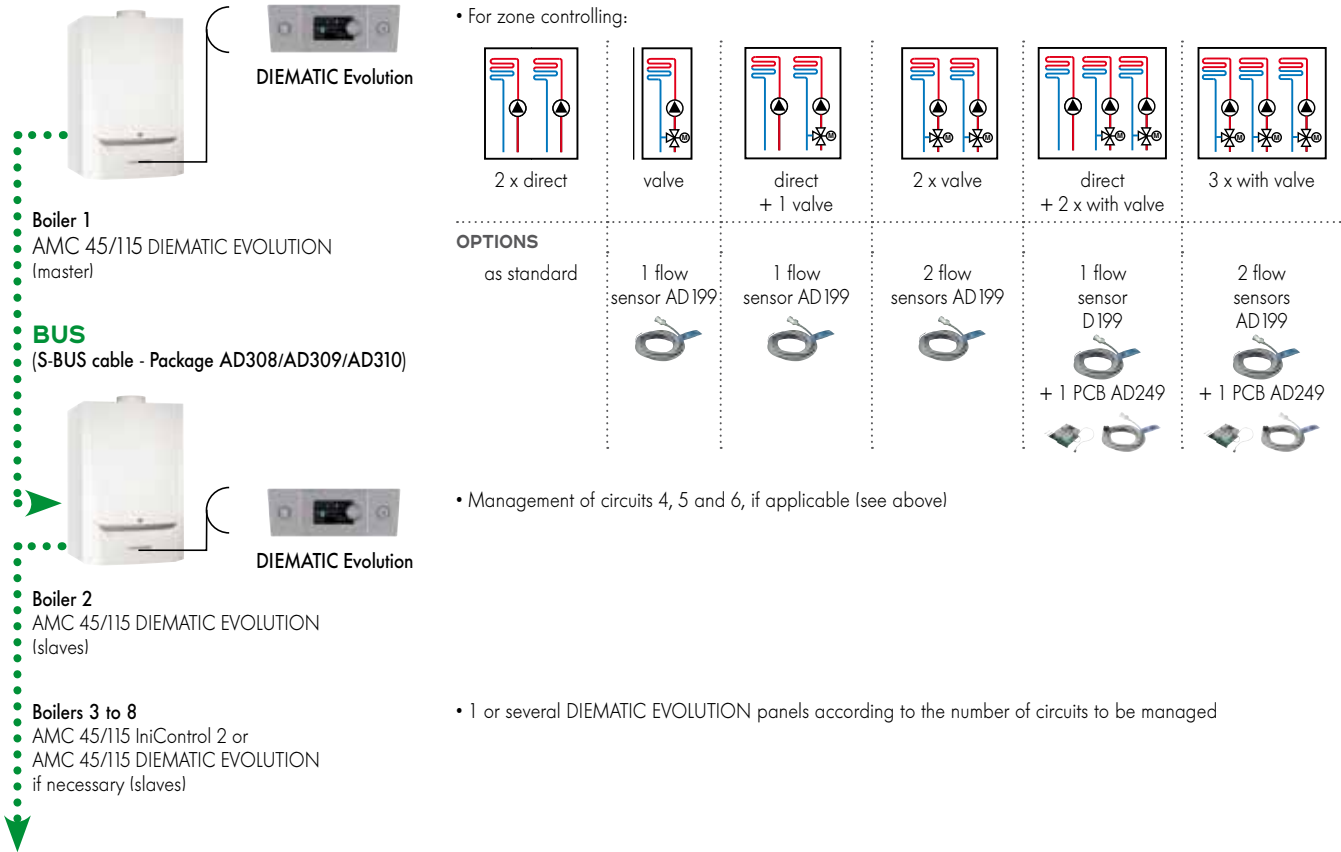

CONTROL PANEL

DIEMATIC EVOLUTION

PRESENTATION OF THE DIEMATIC EVOLUTION CONTROL PANEL

The **DIEMATIC EVOLUTION** control panel is a highly advanced panel with new ergonomic controls, with a built-in programmable electronic control system as standard which modulates the boiler temperature by acting on the **modulating burner**, based on the outdoor temperature and possibly the room temperature if a thermostat or a room sensor (supplied as an option) is connected.

As standard, the DIEMATIC EVOLUTION is able to automatically run a central heating system with 1 or 2 direct circuits without mixing valve and 2 circuits with mixing valve (however the flow sensors - package AD199 - must be ordered separately).

By simply adding 1 "PCB + sensor for 1 valve circuit" option (package AD249), it will be possible to control up to 3 circuits in total, with the option to equip each of these circuits with a room thermostat (option).

Connecting a domestic hot water sensor can be used to program and regulate a DHW circuit (package AD212 - option).

This control system has been specifically developed to enable **optimal management of systems combining different heating generators** (boiler + heat pump or + solar system...). It allows the installer to configure the entire heating system, no matter how complex.

For larger installations, it is also possible to connect up to 8 boilers in cascade configuration.

The DIEMATIC EVOLUTION panel will then be used as the master for the installation, with the slave boilers equipped with the InControl 2 control panel. To connect more than the 3 circuits available on the master boiler, a second boiler (or several boilers) with DIEMATIC EVOLUTION can be included in the cascade.

Pictograms with info on the installation (circuit temperature, outside air temperature, circuits, etc.)

Date and time

Button to go back to the previous level or menu

On/Off button

Button for the main display

Status indicator LED:
- continuous green = normal operation
- flashing green = warning
- red = blockage
- continuous red = locked



Dialogue and information fields
Current menu display

Socket for the PC connection

AMC_Q0012

Rotary/push button:
- turn to select a menu or parameter
- press to confirm the selection

DIEMATIC EVOLUTION CONTROL PANEL OPTIONS



8519Q0022

SENSOR FOR DOMESTIC HOT WATER (LENGTH 5 m) - PACKAGE AD212

It allows regulation with temperature prioritised and programming of domestic hot water production via an independent tank.



GT220_Q0002

FLOW SENSOR DOWNSTREAM OF VALVE (LENGTH 2.5 m) - PACKAGE AD199

This sensor is necessary for connecting the 1st circuit with mixing valve on a boiler equipped with the DIEMATIC EVOLUTION control panel.



8519Q0022

SENSOR FOR BUFFER TANK - PACKAGE AD250

Comprises 1 sensor for managing a buffer tank with a boiler equipped with a DIEMATIC EVOLUTION control panel



MCA_Q0013

PCB + SENSOR FOR 1 MIXING VALVE - PACKAGE AD249

It is used to control a mixing valve with an electromechanical or electrothermal motor. The PCB is inserted in the DIEMATIC EVOLUTION panel and is connected using plug-in connectors. DIEMATIC EVOLUTION can house 1 "PCB + sensor" option, enabling it to control 1 additional mixing valve.

DIEMATIC EVOLUTION CONTROL PANEL OPTIONS (CONTINUED)

AD137



AD200



AD140



8666QI120A + 8801C0003

WIRED PROGRAMMABLE ROOM THERMOSTAT - PACKAGE AD137

WIRELESS PROGRAMMABLE ROOM THERMOSTAT - PACKAGE AD200

NON-PROGRAMMABLE ROOM THERMOSTAT - PACKAGE AD140

Programmable thermostats provide weekly programming and regulation of the heating by activating the burner according to the various operating modes: "Automatic" depending on the programming, "Permanent" at a set temperature or "Holiday". The "wireless" version is delivered with a receiver box to be mounted on the wall close to the boiler. The non-programmable thermostat is used to regulate the room temperature based on the setpoint, by activating the burner.

AD308



AD310



AD309



AD321



MCA_Q0151 + MCA_Q0150 + MCA_Q0152 + MCA_Q0152 + MCA_Q0152 + MCA_Q0152

S-BUS CABLE WITH PLUGS, 1.5 m - PACKAGE AD308

S-BUS CABLE WITH PLUGS, 12 m - PACKAGE AD309

S-BUS CABLE WITH PLUGS, 20 m - PACKAGE AD310

BUS TERMINAL - PACKAGE AD321

The BUS cable enables two boilers equipped with the DIEMATIC EVOLUTION or IniControl 2 panel to be connected as part of a cascade installation.

AD124



AD134



DB119



8199C063/8801C021/8801C022

MOD-BUS CABLE, 1.5 m - PACKAGE AD124

MOD-BUS CABLE, 12 m - PACKAGE AD134

MOD-BUS CABLE, 40 m - PACKAGE DB119

Enables an AMC boiler (any model) to be added as a slave boiler to a cascade of EVODENS AMC boilers.



REG_Q0003

GTW08 L-BUS-MODBUS GATEWAY - PACKAGE AD332

Many BMS use the Modbus as a communication protocol for Centralised Technical Management. Despite being a non-proprietary protocol, the Modbus has parameters that may differ from one application to another. This is why our communication gateways that transform our proprietary buses into standard Modbus RTU RS485 have adjustable parameters such as speed, parity and stop bit.

AD324



SMARTC_Q007

SMART TC° CONNECTED ROOM THERMOSTAT (WIRED) - PACKAGE AD324

SMART TC° enables remote control of the heating and domestic hot water via a free to download application easy for the user to learn, with the option of providing a professional with access to their installation.

It enables a precise remote temperature and modulation control, integrates several timer programs with programming help, gives access to the installation parameters including energy consumption indicators with data saving.

If the SMART TC° can operate as a classic remote control, without Wifi or application, it is recommended to connect it to the internet to benefit from the latest updates.

PRESENTATION OF THE IniControl 2 CONTROL PANEL

The IniControl 2 control panel is used to manage the boiler (without programming) via a configurable 0 - 10 V signal. For a cascade installation, the IniControl 2 panel will be fitted to the slave boilers linked in series to the master boiler equipped with the DIEMATIC EVOLUTION panel via the BUS cable (option).

The boiler temperature, heating network pressure, and generator operating status are displayed using alphanumeric codes and symbols on a large screen integrating a flashing alarm function.

For monitoring the installation, there is an option to read the fault log and the hour run meters.

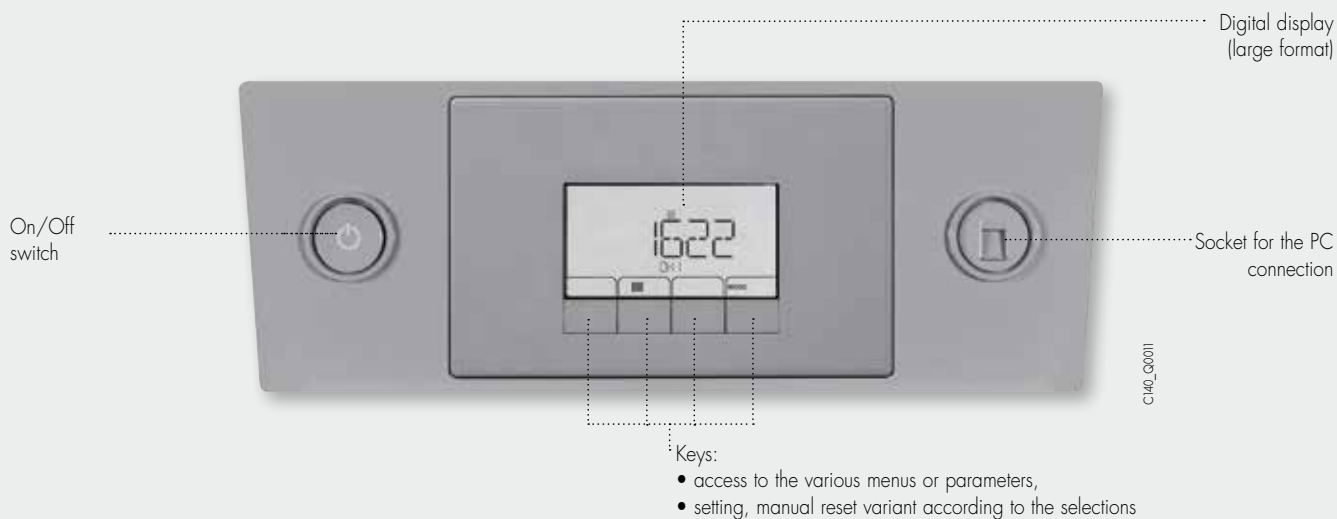

BOILER OPTIONS

DESCRIPTION OF THE DIFFERENT PACKAGES



MCA_Q0035

HYDRAULIC CONNECTION KIT (DELIVERED NON EQUIPPED) - PACKAGE HC139

This kit includes:

- 1 Rp 1 1/4 heating flow valve integrating the filling and drain valve
- 1 Rp 1 1/4 heating return valve with 3-bar safety valve and connection for the expansion vessel
- 1 gas tap Rp 3/4.



MC35E_Q0012

STRAIGHT GAS VALVE 3/4" - PACKAGE HC158

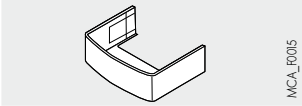

MCA_F015

PIPING COVER - PACKAGE HC242

Allows for a sleek finish underneath the boiler. This package is not compatible with HC139 connection kits.



MCA_Q0034

PRIMARY PUMP FOR AMC 45 - PACKAGE HC147 (supplied with two "1/2 union" 1" 1/2 - 1" connectors)

This pump can also function as an injection pump in cascade installations.

specifications for the GRUNDFOS ALPHA2 L 25-60 180 pump

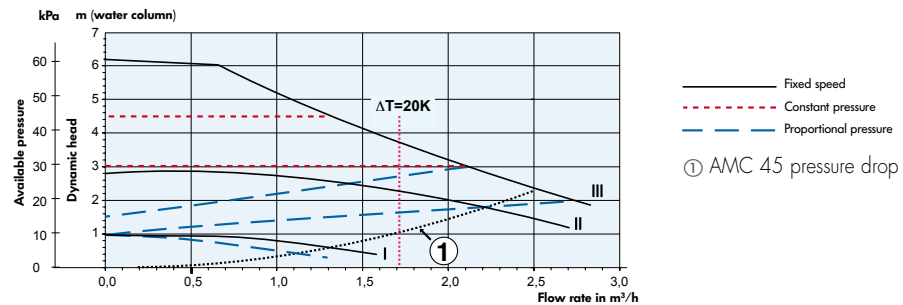

MCA_F016



MCA_Q0038

PRIMARY PUMP FOR AMC 65-90-115 - PACKAGE SA13 (supplied with two "1/2 union" 1" 1/2 - 1" connectors)

This pump can also function as an injection pump in cascade installations.

specifications for the GRUNDFOS UPML 25-95-130 pump

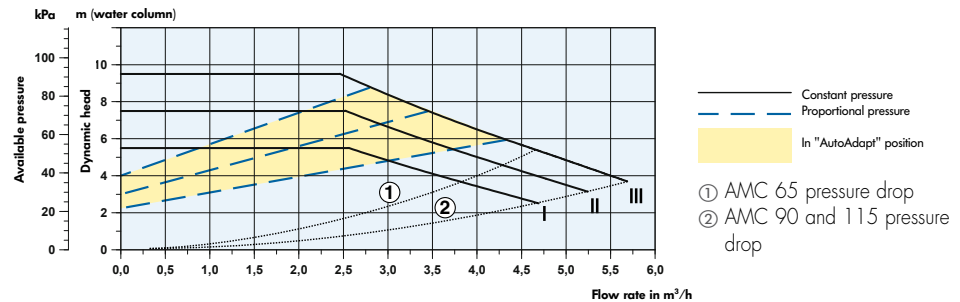

MCA_F019



MCA_Q0148

PROPANE KIT FOR AMC 90 - REF. 7606393

This kit includes a gas valve preadjusted to run on propane for the AMC 90. It is supplied with the accessories needed to be assembled on the boiler. There is no need of any kit for the other boiler executions

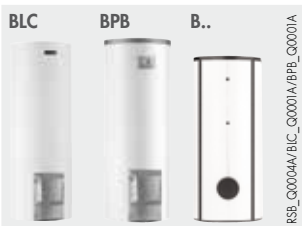

RSE_Q0004A/B/C_Q0001A/BPB_Q0001A

DOMESTIC HOT WATER PRODUCTION

The De Dietrich independent tanks in the B... series, with a capacity of 150 to 3000 litres, enable production of domestic hot water for individual and collective housing, and industrial and commercial premises. They are protected internally by food safety quality high-quartz vitrified enamel, and by a magnesium anode. The specifications and performance of these tanks is given in the price catalogue and respective technical brochures.

BOILER OPTIONS

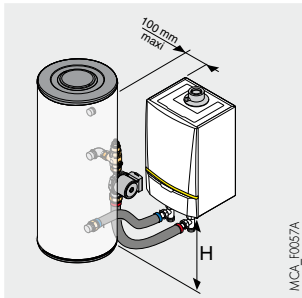

MCA_F0057A

CONNECTION KIT FOR AMC 45, 65, 90 AND 115 BOILERS/INDEPENDENT OR SOLAR TANKS - PACKAGE EA121

This kit also includes the booster pump, 1 non-return valve, 1 manual vent, stainless connection hoses... allowing 1 AMC boiler to be connected to an independent DHW or solar tank, on the right- or left-hand side of the boiler.

H mm	BPB/BLC	UNO BSL, BSL... N
	max. 1080	min. 800



MCA_Q0188

LOW-LOSS HEADER:

- 60/60 - 1" FOR AMC 45 AND AMC 65 - PACKAGE GV45
- 80/60 - 1" 1/4 FOR AMC 90 AND AMC 115 - PACKAGE GV46
- 120/80 - 2" - PACKAGE GV47

For any installations with several circuits or for cascade installations, the use of a low-loss header is strongly recommended.

The headers are provided with insulation and fitted with a wall-mounting bracket and an accessories kit comprising a plug, an air vent and a 1/2" drain valve.



C330_Q0008/C210_Q0014/C330_Q0007/C330_Q0006/C330_Q0005/DN1_Q0001

GRAVITY FLOW CONDENSATES NEUTRALISATION STATIONS:

- DN1 (UP TO 75 KW) - PACKAGE SA1
- DN2 (UP TO 450 KW) - PACKAGE SA3
- DN3 (UP TO 1300 KW) - PACKAGE SA9

CONDENSATES NEUTRALISATION STATION WITH LIFT PUMP FOR BOILERS OR BOILERS IN A CASCADE INSTALLATIONS:

- UP TO 120 KW - PACKAGE DU13
- UP TO 300 KW - PACKAGE SA4
- UP TO 1300 KW - PACKAGE DU15

The materials used for the condensate drain pipes must be appropriate. Otherwise, the condensate must be neutralised.

PRINCIPLE

Acid condensates are conveyed via a reservoir filled with granulates before being sent to the wastewater network.

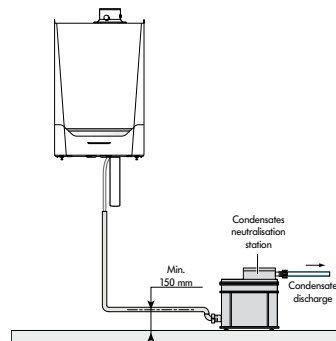

DN1_Q0002

INSTALLATION SUPPORT FOR NEUTRALISATION STATION - PACKAGE SA2

This support is used to attach the SA1 neutralisation tray to the wall.



C330_Q0009

GRANULATE RECHARGE FOR NEUTRALISATION STATION:

- REF. 9422-5601 (10 KG)
- PACKAGE SA7 (25 KG)

An annual inspection of the system is required, including a check of the effectiveness of the granulates via a pH measurement. If necessary, the granulates must be replaced.



C210_Q0016

BOILER BODY CLEANING TOOL:

- PACKAGE HC246 FOR AMC 45 AND AMC 65
- PACKAGE HC247 FOR AMC 90 AND AMC 115

Allows the heat exchanger to be cleaned via its inspection hatch.

BOILER OPTIONS



300 MBAR GAS PRESSURE REGULATOR:

- GDJ 15 (FROM 40 TO 150 KW) Ø 1/2" - PACKAGE SA11
- GDJ 20 (FROM 150 TO 340 KW) Ø 3/4"- PACKAGE SA12
- GDJ 25 (FROM 340 TO 700 KW) Ø 1" - PACKAGE AD245

It is fitted on the gas inlet circuit. It is needed if the gas is supplied at a pressure of 300 mbar.

CONTROL UNIT	MAX. NATURAL GAS FLOW RATE IN m³/H	MAX POWER CONSUMED IN KW	CONNECTION Ø
GDJ 15	15	150	Rp 1/2
GDJ 20	24	240	Rp 3/4
GDJ 25	70	700	Rp 1

FLUE GAS SYSTEM ACCESSORIES SPECIFIC TO EVODENS PRO BOILERS

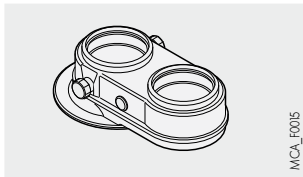

BI-FLOW ADAPTER:

- Ø 80/125 mm ON 2 X Ø 80 mm - PACKAGE DY906
- Ø 100/150 mm ON 2 X Ø 100 mm - PACKAGE DY907

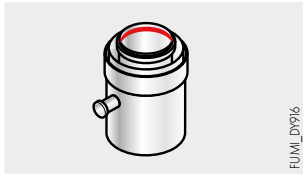

CONDENSATE COLLECTOR:

- Ø 80/125 mm - PACKAGE DY916
- Ø 110/150 mm - PACKAGE DY918

CASCADE SYSTEMS

AMC 45 to 115 cascade systems are available in 3 versions: • **LW**: pour for wall-mounted alignment of the constituent boilers, • **LV**: for floor-mounted alignment of the constituent boilers. • **RG**: back to back alignment

These systems comprise:

- the low-loss header: 1 header model up to 350 kW, 1 other model for outputs > 350 kW,
 - the boiler connection manifold comprising the heating return and flow connecting pipes (Ø 65 mm), the gas connecting pipes (Ø 50 mm) welded onto the manifold (as per the requirements of DTU 61.1), and the flanges,
 - the class A modulating primary injection pumps (EEI < 0.23),
 - the boiler connection kits with the multifunction flow valve, return valve (with the filling and drain valve, gate valve, non-return valve, safety valve and port for connecting to an expansion vessel), and the gas valve
 - the wall mounting rail for the LW versions or the support uprights for LV versions, with the boiler mounting frames,
 - the flow sensor + pocket sensor and the BUS cables to connect the boilers.
- NOTE: the boilers must be ordered separately.

• “LW” WALL-MOUNTED ALIGNMENT OF BOILERS

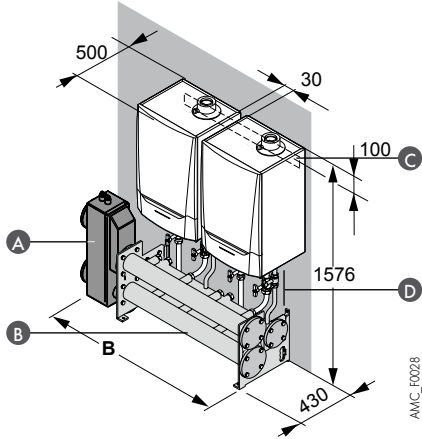

A Low-loss header
B Manifold
C Wall mounting rail
D Boiler connection kit

• “LV” FLOOR-MOUNTED ALIGNMENT OF BOILERS

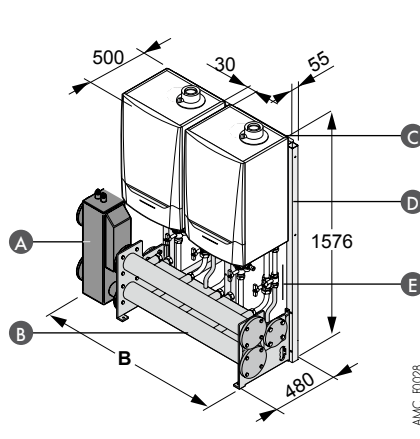

A Low-loss header
B Manifold
C Assembly frame
D Support upright
E Boiler connection kit

• “RG” BACK TO BACK ALIGNMENT

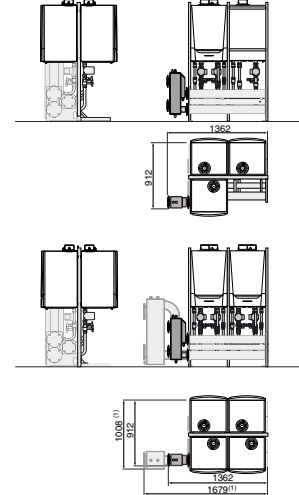
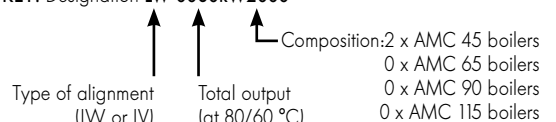

TABLE WITH EXAMPLES OF “CASCADE” COMBINATIONS FROM 80 TO 856 KW PROPOSED BASED ON THE TOTAL OUTPUT REQUIRED

ALIGNMENT	NUMBER OF BOILERS	OUTPUT (80/60°C) KW	TYPE OF AMC BOILER				B mm	WATER FLOW RATE ΔT = 20K		DESCRIPTION (*)
			45	65	90	115		M³/H		
WALL-MOUNTED	2	080	2	0	0	0	1337	3,43	LW.0080kW.2000	
		122	0	2	0	0	1337	5,23	LW.0122kW.0200	
		168	0	0	2	0	1337	7,20	LW.0168kW.0020	
		214	0	0	0	2	1337	9,17	LW.0214kW.0002	
	3	120	3	0	0	0	1867	5,14	LW.0120kW.3000	
		183	0	3	0	0	1867	7,84	LW.0183kW.0300	
		252	0	0	3	0	1867	10,80	LW.0252kW.0030	
		321	0	0	0	3	1867	13,76	LW.0321kW.0003	
	4	160	4	0	0	0	2397	6,86	LW.0160kW.4000	
		244	0	4	0	0	2397	10,46	LW.0244kW.0400	
		336	0	0	4	0	2397	14,40	LW.0336kW.0040	
		428 (1)	0	0	0	4	2739	18,34	LW.0428kW.0004	
FLOOR-MOUNTED	2	080	2	0	0	0	1362	3,43	LV.0080kW.2000	
		122	0	2	0	0	1362	5,23	LV.0122kW.0200	
		168	0	0	2	0	1362	7,20	LV.0168kW.0020	
		214	0	0	0	2	1362	9,17	LV.0214kW.0002	
	3	120	3	0	0	0	1892	5,14	LV.0120kW.3000	
		183	0	3	0	0	1892	7,84	LV.0183kW.0300	
		252	0	0	3	0	1892	10,80	LV.0252kW.0030	
		321	0	0	0	3	1892	13,76	LV.0321kW.0003	
	4	160	4	0	0	0	2422	6,86	LV.0160kW.4000	
		244	0	4	0	0	2422	10,46	LV.0244kW.0400	
		336	0	0	4	0	2422	14,40	LV.0336kW.0040	
		428 (1)	0	0	0	4	2739	18,34	LV.0428kW.0004	
BACK TO BACK	3	120	3	0	0	0	-	5,14	RG.0120kW.3000	
		183	0	3	0	0	-	7,84	RG.0183kW.0300	
		252	0	0	3	0	-	10,80	RG.0252kW.0030	
		321	0	0	0	3	-	13,76	RG.0321kW.0003	
	4	160	4	0	0	0	-	6,86	RG.0160kW.4000	
		244	0	4	0	0	-	10,46	RG.0244kW.0400	
		336	0	0	4	0	-	14,40	RG.0336kW.0040	
		428 (1)	0	0	0	4	-	18,34	RG.0428kW.0004	

(1) With large header
* Except insulating shells

KEY: Designation LW 0080kW2000



IMPORTANT

other “cascade systems” from 428 to 1070 kW are also possible: to help you identify and enter these, an “Identifying cascades” tool can be accessed on our website.

DESCRIPTION OF THE DIFFERENT PACKAGES



MCA_Q001

DN 50 GAS FILTER FOR CASCADE SYSTEMS FROM 80 TO 428 KW - PACKAGE HC255



MCA_Q0040

SET OF DN 50 WELDING FLANGES FOR GAS FILTER - PACKAGE HC261

Supplied with gaskets, nuts and bolts.



MCA_Q004

SET OF DN 65 90° ELBOWS FOR CASCADE SYSTEMS - PACKAGE HC209

Supplied with gaskets, nuts and bolts.
Enabling the low-loss header to be connected perpendicular to the manifold.



MCA_Q0031

SET OF DN 65 COUNTERFLANGES (TO BE WELDED) FOR CASCADE SYSTEMS FROM 80 TO 428 KW - PACKAGE HC217

Contains 3 counter flanges: 2 for the installation side of the pressure breaker (DN 65) and 1 for the gas line (DN 50).
Supplied with gaskets, nuts and bolts.



MCA_Q0010/MCA_Q0003

LOW-LOSS HEADER INSULATION:

- SMALL MODEL FOR OUTPUT < 350 KW - PACKAGE HC224
- LARGE MODEL FOR OUTPUT > 350 KW - PACKAGE HC215



AMC_Q0026

MANIFOLD INSULATION - PACKAGE HC213

It is necessary to order 1 insulation kit per boiler.

NOTE: for a "back-to-back" installation, this only needs to be ordered for the boilers at the front.



AMC_Q0012

BOILER HYDRAULIC CONNECTION KIT INSULATION - PACKAGE HC252

One lot of insulation is required per boiler connection kit.



MCA_Q0013

90° ELBOW INSULATION DN 65 OR DN 90 - PACKAGE HC216



MCA_Q0027

ADJUSTABLE FOOT - PACKAGE HC219

This is used for "LV" in-line installations, if the ground is not uniform.

ALIGNMENT	IN-LINE, "LV" FLOOR-MOUNTED					
Number of boilers	2	3	4	5	6	7
Number of feet required	5	6	8	9	11	12

Ø 80/100 mm adapter - PACKAGE DY768

FITTING AN AMC BOILER ON AN "LV" CASCADE SYSTEM MADE UP OF EXISTING MC BOILERS

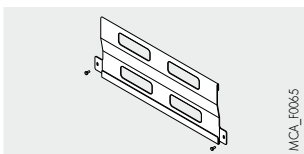

MCA_F0065

AMC MOUNTING RAIL FOR AN MC CASCADE SYSTEM - PACKAGE HC245

This rail is attached to the frame of the existing cascade system ("LV" floor-mounted alignment only) and allows the new AMC boiler to be aligned at the base with the other boilers in the cascade and to connect up its hydraulics without modifying the existing kit.

INFORMATION REQUIRED

FOR INSTALLATION

STATUTORY GUIDELINES FOR INSTALLATION AND MAINTENANCE

Installation and maintenance of the appliance, in both residential buildings and establishments open to the general public, must be performed by a qualified professional in accordance with the relevant statutory guidelines and good industrial practice.

POSITIONING

• AMC 45 AND 65

AMC 45 and 65 boilers can be installed anywhere within the home, provided that this location is not at risk of frost and can be well-ventilated; under no circumstances may it be installed on top of a heat source or cooking appliance. Thanks to their IP X4D International Protection marking, they may be installed in kitchens and bathrooms, although not in protection areas classified as 1 or 2. The wall on which the boiler is to be attached must be able to bear the weight of the boiler when filled with water.

To ensure sufficient access around the boiler, we recommend respecting the minimum dimensions detailed opposite.

ventilation (with chimney connection - type B_{23P}, only):

The room ventilation section must comply with the prevailing standards

NOTE: For boilers connected to a concentric forced flue (type C_{13x} or C_{33x} connections) the installation room does not need to be ventilated, unless the gas supply includes one or more mechanical connections. (cf. prevailing standards)

• AMC 90 AND 115

AMC 90 and 115 boilers shall be installed in accordance with the installation rules governing mini-boiler rooms outside of inhabited areas, in a dedicated room. The installation rules for the terminals (horizontal or vertical) must also be observed.

ventilation:

Direct air supply as per the prevailing standards.

Upper and lower air vents compulsory

- Upper air vent: Cross section equal to half the total cross section of the flue gas pipes with a minimum of 2.5 dm²
- Lower air vent: direct air supply
 $S \text{ (dm}^2\text{)} \geq \frac{0.86 P}{20}$ where P = Installed output in kW

The air inlets will be laid out, in relation to the top ventilation orifices, such that air renewal extends over the entire volume of the boiler room.

See also the recommendations in the "Flue gas system" brochure.

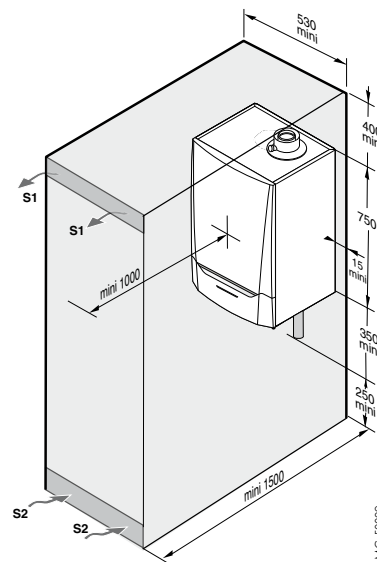

AMC 45 and 65:

S1 and S2:

free spaces of:

- 600 cm² (to connect B₂₃)
- 150 cm² (to connect C_{13x}, C_{33x}, C_{93x}, C₅₃)



In order to avoid damage to the boilers, it is necessary to prevent the contamination of combustion air by chlorine and/or fluorine compounds, which are particularly corrosive. These compounds are present, for example, in aerosol sprays, paints, solvents, cleaning products, washing products, detergents, glues, road grit, etc. The following must therefore be ensured:

- Prevent the intake of air expelled by premises using such products: hairdressing salons, dry cleaners, industrial premises (solvents), premises containing refrigeration systems (risk of refrigerant leakage), etc.
- Avoid storing such products close to boilers.

We would like to underline that, should the boiler and/or peripheral equipment be corroded by chlorine and/or fluorine compounds, the contractual guarantee will be invalidated.

GAS CONNECTION

The applicable regulations and provisions must be complied with. In all cases, a shut-off valve must be placed as close to the boiler as possible. This valve is supplied in the hydraulic connection kits supplied as an option (see p. 9). A gas filter must be fitted at the boiler inlet.

The diameters of the pipes must be defined in accordance with the prevailing standards.

Gas supply pressure:

- 20 mbar with H natural gas
- 25 mbar with L natural gas,
- 37 mbar with propane.

CERTIFICATE OF CONFORMITY

The installer is required to draw up a certificate of conformity approved by the ministries responsible for construction and gas safety.

ELECTRICAL CONNECTION

This must comply with the prevailing standards.

The boiler must be supplied via an electrical circuit which includes an omnipolar switch with an opening gap distance of > 3 mm. Protect the network connection using a 6A fuse.

NOTE:

- The sensor cables must be separated from the 230 V circuits by at least 10 cm,
- To help maintain the frost protection and anti-blocking functions of the pumps, we recommend that the boiler is not powered off using the mains switch.

INFORMATION REQUIRED

FOR INSTALLATION

AIR-FLUE GAS CONNECTION FOR AMC (ALL MODELS)

For information on how to set up the air-flue gas connection ducts and the installation rules, see the "flue system" brochure. For details of the different configurations, see the "flue system" brochure or current price list.

CLASSIFICATION

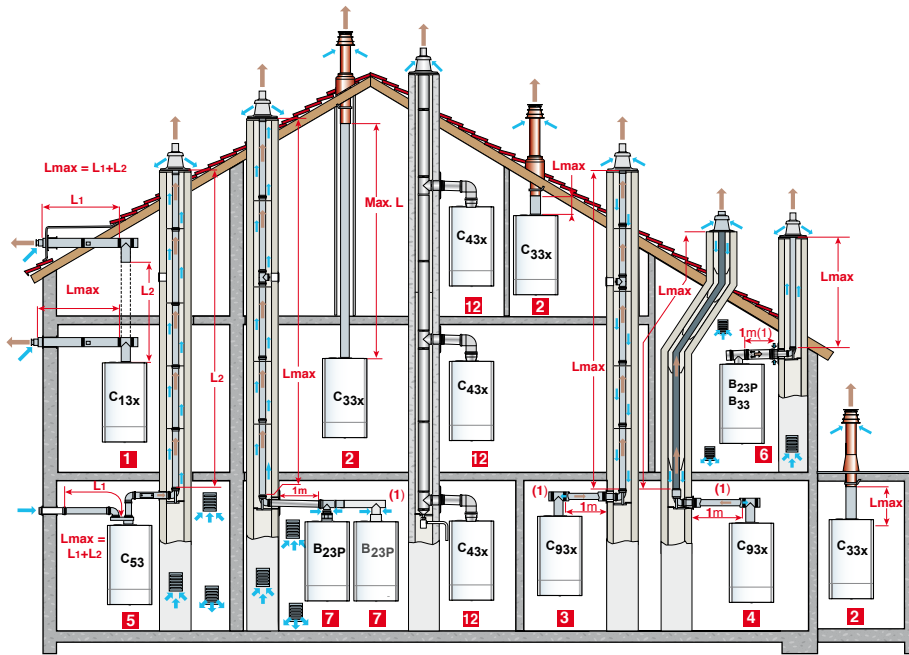

key

- 1** CONFIGURATION C_{13(x)}: Air-flue gas connection via concentric ducts to a horizontal terminal ("forced flue")
- 2** CONFIGURATION C_{33(x)}: Air-flue gas connection via concentric ducts to a vertical terminal (roof outlet)
- 3** CONFIGURATION C_{93(x)}: Air-flue gas connection via concentric ducts in boiler room, single ducts in flue (combustion air in counter-current in flue)
- 4** CONFIGURATION C_{93(x)}: Air-flue gas connection via concentric ducts in boiler room, single "flexi" ducts in flue (combustion air in counter-current in flue).
- 5** CONFIGURATION C₅₃: Separate air and flue gas connection, single ducts (combustion air taken from outside)
- 6** CONFIGURATION B_{23P}/B₃₃: Connection to a chimney (combustion air taken from within the boiler room).
- 7** CONFIGURATION B_{23P}: for cascade installations

TABLE OF MAXIMUM PERMISSIBLE AIR-FLUE GAS DUCT LENGTHS BASED ON THE BOILER MODEL

IMPORTANT
flue gas configuration has to comply with prevailing standards

TYPE OF AIR-FLUE GAS CONNECTION			MAX. L: EQUIVALENT MAXIMUM LENGTH OF THE CONNECTION DUCTS IN METRES			
			AMC			
			45	65	90	115
Concentric pipes connected to a horizontal terminal (PPs)	C _{13(x)}	Ø 80/125 mm	16	-	-	-
		Ø 110/150 mm	-	9	8	5.9
Concentric pipes connected to a vertical terminal (PPs)	C _{33(x)}	Ø 80/125 mm	14.5	-	-	-
		Ø 110/150 mm	-	11.5	10	9.4
Ducts • concentric in boiler room, • single in flue (combustion air in counter-current) (PPs)	C _{93(x)}	Ø 80/125 mm	15	-	-	-
		Ø 80 mm	-	-	-	-
		Ø 80/125 mm	25	-	-	-
		Ø 100 mm	-	16	13.2	10
Ducts - concentric in boiler room, - "flexi" in flue (combustion air in counter-current) (PPs)	C _{93(x)}	Ø 80/125 mm	12	-	-	-
		Ø 80 mm	-	-	-	-
		Ø 110/150 mm Ø 110 mm	-	16.5	13.5	9.4
Bi-flow adapter and separate single air/flue gas pipes (combustion air taken from outside) (Alu)	C ₅₃	Ø 80/125 mm on 2 x 80 mm	20.5	-	-	-
		Ø 100/125 mm on 2 x 100 mm	-	23	17.5	16
In flue (rigid or flexi) (combustion air taken from within the premises) (PPs)	B _{23P} /B ₃₃	Ø 80 mm (rigid)	23.5	-	-	-
		Ø 80 mm (flexi)	21	-	-	-
		Ø 110 mm (rigid)	-	40	40	40
		Ø 110 mm (flexi)	-	29.5 (II)	24	17.5

(1) ⚠: The max. height in the flue gas pipe (Configuration C_{93(x)}, B_{23P}/B₃₃) of the support elbow at the outlet must not exceed 25 m for the flexi PPS. If lengths used do exceed this, mounting brackets must be added every 25 metres.

IMPORTANT

- Remindert: For type B₂₃ and B_{23P} configurations, mixed use of materials is prohibited.
- Please be reminded that the following page gives the installation rules for sealed appliance terminals (type C) with a total output of 70 kW installed in a boiler room and using gas type fuels

INFORMATION REQUIRED

FOR INSTALLATION

WATER CONNECTIONS

IMPORTANT

Condensing boilers are based on the principle of recovering the energy contained in the steam from the flue gases (latent heat of vaporisation). As a result, to achieve an annual operating efficiency of around 108%, the heating surfaces must be sized so as to obtain low return temperatures, below the dewpoint (for example, underfloor heating, low temperature radiators, etc.). This must be ensured throughout the heating period.

CONDENSATE DISCHARGE

The installation must be connected to the wastewater drainage system. The connector must be removable, and the flow of condensates must be visible. The connectors and pipes must be made from corrosion-resistant material. A condensate neutralisation system is available as an option.

CONNECTION TO THE HEATING CIRCUIT

AMC boilers must only be used in closed circuit heating systems. Before final filling, new installations must be cleaned to remove debris (copper, caulking, soldering flux) resulting from the set-up of the distribution networks and transmitters to prevent any deposits which could lead to malfunctions (noises in the installation, chemical reaction between the metals). If a new boiler is set up in a renovated boiler room, it is strongly recommended that the installation is cleaned/flushed before it is fitted.

It may be necessary to install appropriate filters in some cases.

After such interventions, particular attention must be paid to the quality of the water used to fill the installation to ensure the new boiler can produce the expected performances.

REQUIREMENTS RELATING TO HEATING WATER

TOTAL INSTALLATION CALORIFIC OUTPUT (KW)		70-200	200-550	550
Degree of acidity (untreated water)	pH	7 - 9	7 - 9	7 - 9
Degree of acidity (treated water)	pH	7 - 8.5	7 - 8.5	7 - 8.5
Conductivity at 25°C	µS/cm	800	800	800
Chlorides	mg/l	50	50	50
Other components	mg/l	1	1	1
	°f	1 - 20	1 - 15	1 - 5
Total water hardness (l)	°dH	0.5 - 1.2	0.5 - 8.4	0.5 - 2.8
	mmol/l	0.1 - 2.0	0.1 - 1.5	0.1 - 0.5

(l) For installations heated at constantly high temperatures with a total installed calorific output of up to 200 kW, a maximum total water hardness of 8.4 °dH (1.5 mmol/l, 15°F) applies: for outputs exceeding 200 kW, a maximum total water hardness of 2.8 °dH (0.5 mmol/l, 5°F) applies.

WATER TREATMENT

If, however, it is necessary to have the water treated to ensure it respects the filling water quality requirements, please consult: contact a water treatment specialist who should be able to ensure that the water quality complies with the mix of materials present in the installation, taking all of its components into account.

OPERATING FLOW RATE WITH THE LOW-LOSS HEADER KIT		EVODENS PRO AMC			
		45	65	90	110
Minimum flow rate	m ³ /h	0.195	0.290	0.340	0.455

INSTALLATION EXAMPLES

The examples shown opposite cannot include all of the possible installation scenarios that may be encountered. They are intended to draw attention to the basic rules to be respected. A number of safety and control components (including some built into the boilers as standard) are shown, though ultimate responsibility for providing the final safety and control components in the boiler room, based on its individual requirements, lies with the installers, consultant engineers and design offices. In every case, it is important to comply with the applicable regulations and adhere to good industrial practice.

NB: When connecting on the domestic hot water side, if the distribution pipes are made from copper, a sleeve made from steel, cast iron or any other insulating material must be placed between the hot water outlet and these pipes in order to prevent any corrosion phenomena on the connections.

EXAMPLES OF INSTALLATIONS WITH A SINGLE BOILER:

DIEMATIC EVOLUTION CONTROL PANEL

installation of an AMC DIEMATIC EVOLUTION with 1 direct circuit + 1 BPB/BLC type domestic hot water tank

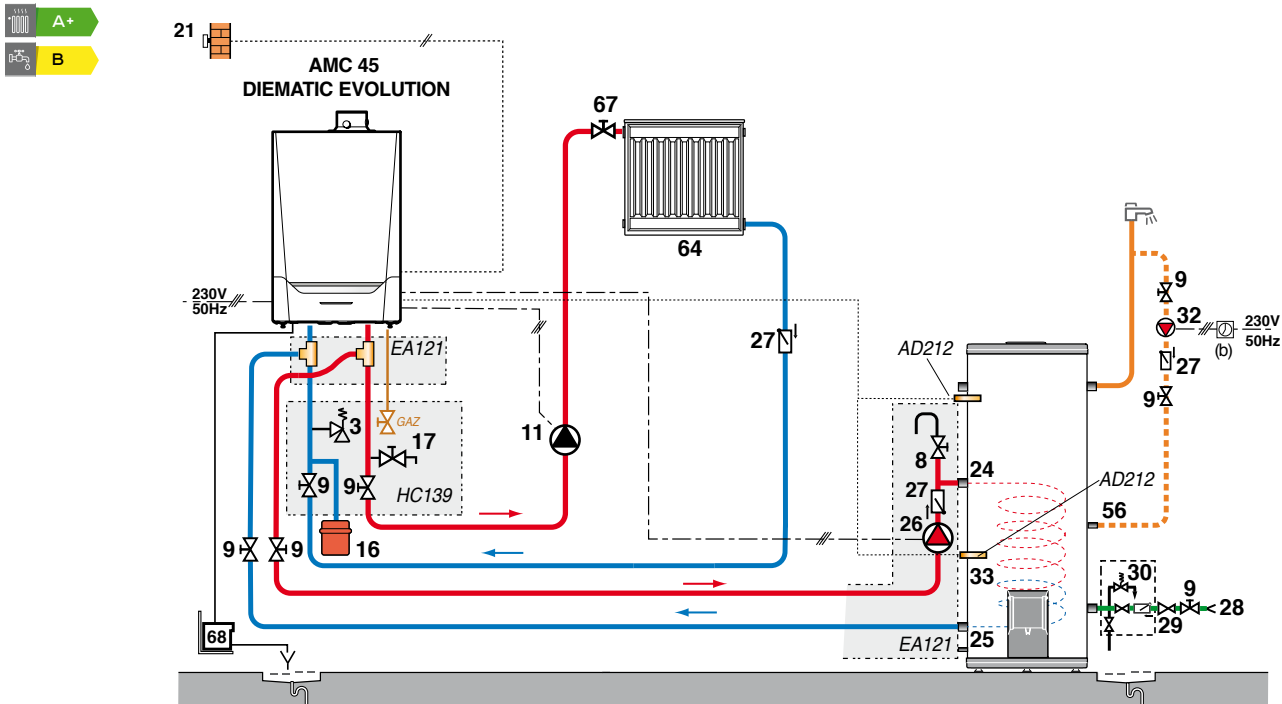

AMC_F0031

installation of an AMC DIEMATIC EVOLUTION with 1 direct circuit + 2 circuits with mixing valve + 1 BPB/BLC type domestic hot water tank, all four behind a low-loss header

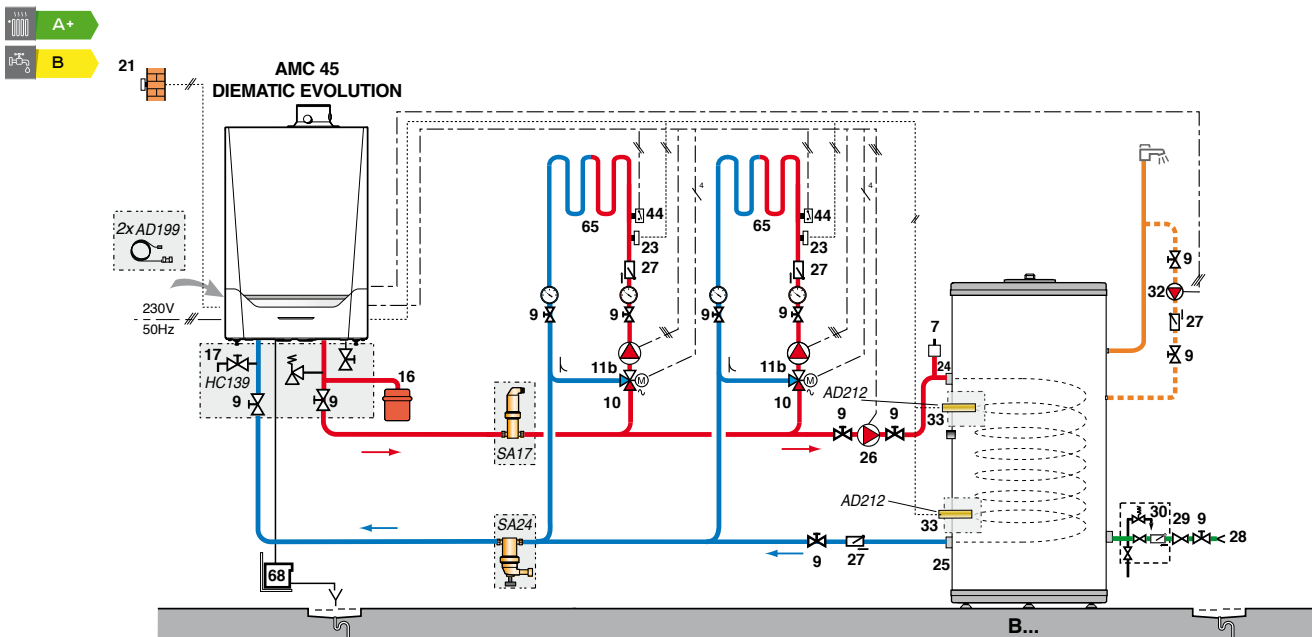

AMC_F0023

KEY: see page 21

INSTALLATION EXAMPLES

Installation of an AMC (any model) EVOLUTION with 1 radiator circuit + 1 circuit with mixing valve + 1 DHW circuit, all three behind a low-loss header

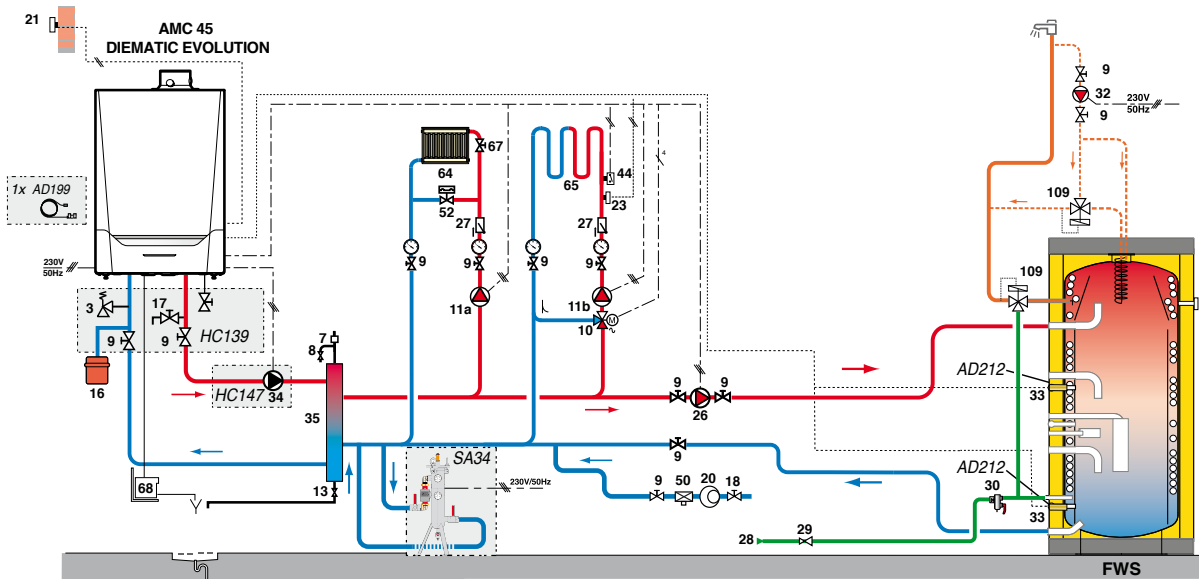

AMC_FC033

KEY: see page 21

INSTALLATION EXAMPLES

EXAMPLES OF CASCADE INSTALLATIONS:

installation of 3 boilers in cascade including 1 AMC DIEMATIC EVOLUTION boiler and 2 AMC inicontrol 2 boilers with 1 direct circuit + 2 circuits with mixing valve and 1 DHW circuit

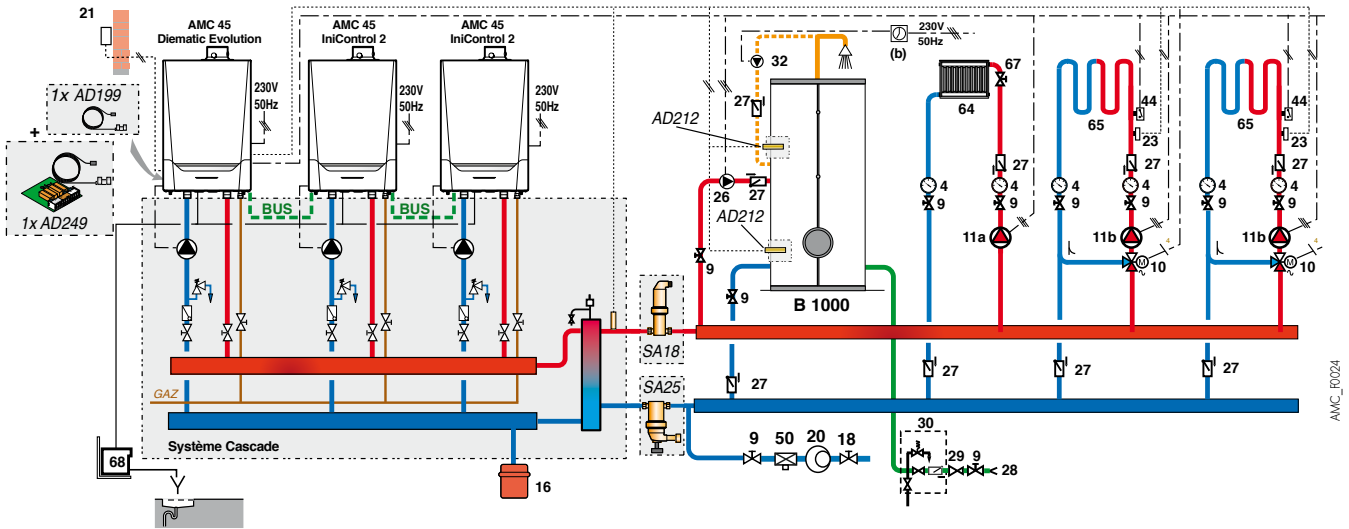

specific case of a cascade installation with more than 2 secondary circuits with mixing valve:
 installation of 2 AMC PRO...DIEMATIC EVOLUTION boilers in cascade with 4 circuits with mixing valve and one circuit with convection fans. DHW is made by an FWPC instant DHW tank

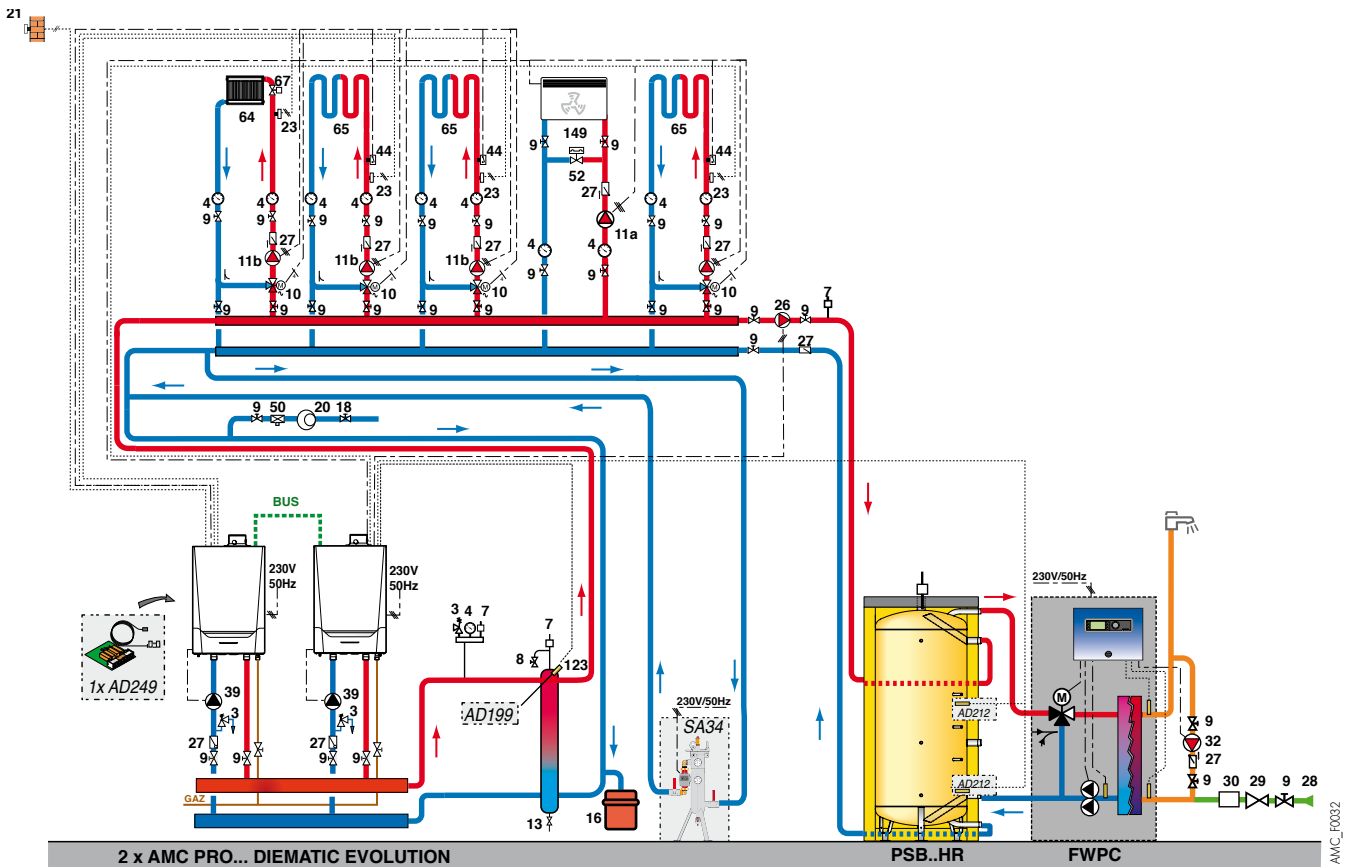

KEY: see page 21

INSTALLATION EXAMPLES

Installation of AMC Inicontrol 2 boilers (any model) in cascade

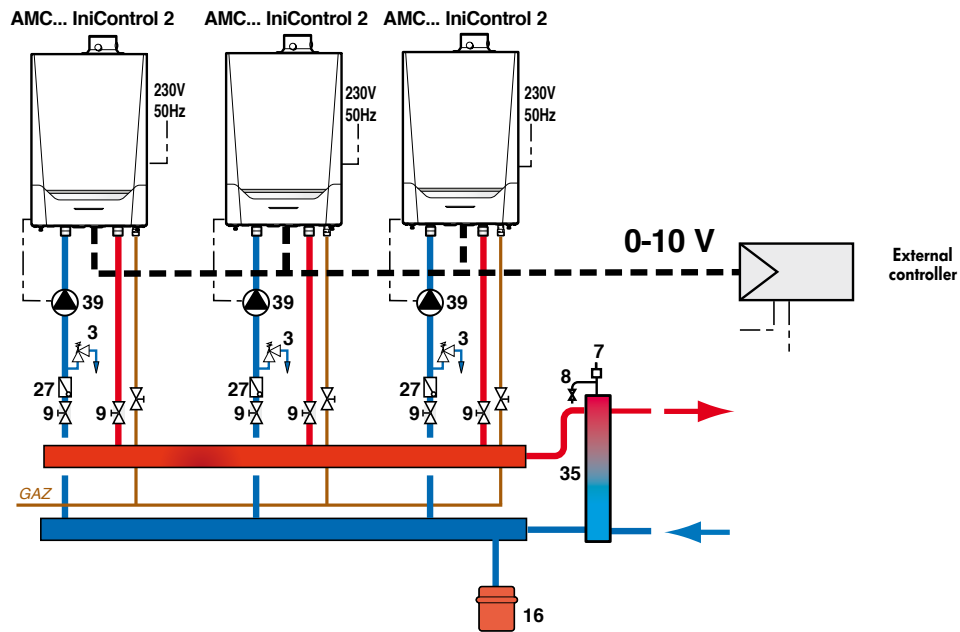

NOTE: For a cascade installation with AMC Inicontrol 2 boilers only (any model), the BUS cables and the cascade flow sensor supplied with the system are not used.

KEY

- | | | |
|---|---|--|
| 1 Heating flow | 23 Flow temperature sensor downstream of mixing valve | 44 65°C limiter thermostat with manual reset for underfloor heating (DTU 65.8, NFP 52-303-1) |
| 2 Heating return | 24 DHW tank exchanger primary inlet | 46 3-way directional valve with reversal motor |
| 3 3-bar safety valve | 25 DHW tank exchanger primary outlet | 56 DHW circulation loop return |
| 4 Pressure gauge | 26 Cooling pump | 64 Radiator circuit (e.g. gentle heating radiators) |
| 7 Automatic air vent | 27 Non-return valve | 65 Low temperature circuit (e.g. underfloor heating) |
| 8 Manual air vent | 28 Domestic cold water inlet | 67 Manual valve |
| 9 Isolation valve | 29 Pressure reducer | 68 Condensate neutralisation system (optional) |
| 10 Three-way mixing valve | 30 Safety unit calibrated and sealed to 7 bar | 81 Immersion heater |
| 11 Electronic heating accelerator | 32 DHW circulation loop pump (optional) | 84 Stop valve with releasable non-return valve |
| 11a Electronic heating accelerator for direct circuit | 33 DHW temperature sensor | 87 Safety valve calibrated to 6 bar and sealed |
| 11b Heating accelerator for circuit with mixing valve | 34 Primary pump | 109 Thermostatic mixing valve |
| 13 Flush valve | 35 Low-loss header (can be supplied as an option - see page 11) | 123 Cascade flow sensor (to be connected to the slave boiler) |
| 16 Expansion vessel | 39 Injection pump | (b) External clock |

DESCRIPTION

EVODENS PRO AMC ..

WALL-HUNG GAS-FIRED CONDENSING BOILER FOR HEATING ONLY

Brand: De Dietrich

Model:

- AMC 45
- AMC 65
- AMC 90
- AMC 115

Homologation: B_{23p} - B₃₃ - C_{13(x)} - C_{33(x)} - C_{93(x)} - C_{63(x)} - C₅₃

Protection index: IP X4D

Power supply: 230 V/50 Hz

Gas category: all natural gases, propane

Nominal useful heating output determined at Q_{nom}: ... kW

Intermediate useful heating output 30 % Q_{nom}: ... kW

Useful heating output 50/30 °C: ... kW

Min./max. useful heating output 80/60 °C: ... kW

Efficiency on LHV at 30 % load (return temp. 30 °C): ... %

Efficiency on LHV at 100 % load (return temp. 70 °C): ... %

Max. temperature: 90°C

Max. operating pressure: 4 bar

Seasonal efficiency, product SEE (without control system): ... %

Seasonal efficiency, product SEE (with outdoor temperature sensor): ... %

Standby losses at ΔT 30 K: ... W

Auxiliary electrical output (excluding circulating pump): ... W

Electrical output of auxiliaries in standby: ... W

Water content: ... litres

Flue gas outlet diameter: ... mm

Pressure available at boiler outlet: ... Pa

Dimensions: 500 (L) x 750 (H) x 500 (D) mm

Net weight: ... kg

DESCRIPTION

Complies with the requirements of European directives.

Heating production will be provided by a sealed wall-hung gas-fired condensing boiler for heating only. Its exchanger will be a packaged aluminium-silicon alloy model with high corrosion resistance and a large exchange surface, **operating without minimum flow** (flow T° < 75 °C), and able to manage a **40 K difference** between the flow and the return. The exchanger will have low hydraulic pressure loss and will be accessible via the front of the boiler. The entire flue gas circuit will be accessible. The gas burner will be a total premix model with woven metal fibre surfaces and a silencer on the air intake. Ignition and flame monitoring will take place with an ionisation electrode. The modulation range will be **18 to 100 %**. A condensate collector will be integrated and equipped with a siphon as standard. The boiler will be equipped with heating body flow/return sensors. A flue gas non-return valve will be integrated as standard in the boiler.

The boiler will be controlled via the **Diematic EVOLUTION** panel, which integrates a programmable electronic control system that can control up to 3 circuits with three-way valves, 1 direct circuit and 1 DHW circuit. PWM control of the boiler pump speed based on the burner output and the heating body ΔT°. This control system will communicate using Modbus RTU RS485 via our optional gateway.

The boiler will include a fault reporting output and a 0-10 V input.

SPECIFIC FEATURES

Cascades of up to 8 boilers:

- Diematic Evolution control system according to the outside temperature, enabling management of a direct circuit, DHW production and with an option of up to 2 valve circuits. Including heat energy metering, high temperature zone control and swimming pool functions.
- IniControl 2 control system for slave boilers or boilers controlled by 0-10V contact entry.

BOILER OPTIONS

- Hydraulic connection kit
- Modulating primary pump
- Low-loss header (mandatory for cascade operation)
- Condensate neutralisation station
- Bracket for neutralisation station
- Granulate recharge (25 kg) for station
- Condensate neutralisation station with lift pump
- Granulate recharge (10 kg) for station
- Piping cover
- Gas tap
- Heating body cleaning tool
- Flue gas system accessory gas pressure regulator for assembly compliant with the prevailing standards

CASCADE KIT OF 2 TO 8 BOILERS COMPRISING:

- Low-loss header
- Boiler connection collector
- Injection pumps
- Boiler connection hydraulic kits
- Optional insulating shells

DIEMATIC CONTROL OPTIONS:

- Wired remote control
- DHW sensor
- Room temperature sensor
- Three-way valve flow sensor
- PCB + sensor for mixing valve
- S-BUS Diematic Evolution connection cable (1.5, 12 and 20 m) for cascade
- Sensor for buffer tank or cascade flow

Dip sensor+sensor tube

VM evolution (up to 3 additional valve circuits)

GTW08 L-Bus Modbus RS485 communication gateway

Empty rectangular box for notes.

ENERGY LABELLING

Each boiler is supplied with its energy label. This contains a host of information: energy efficiency, annual energy consumption, name of manufacturer, noise level, etc.

By combining your boiler with a solar system, a DHW storage tank, a control system or even another generator, you can improve the performance of your

installation and generate a "System" label corresponding to your installation: [visit our site "www.ecodesign.dedietrich-heating.com"](http://www.ecodesign.dedietrich-heating.com)



De Dietrich ECO-SOLUTIONS give you the latest generation of multi-energy products and systems: simpler, more efficient and more economical to guarantee your comfort and protect the environment.

The energy label associated with the ECO-SOLUTIONS label indicates the product performance.

www.ecodesign.dedietrich-heating.com

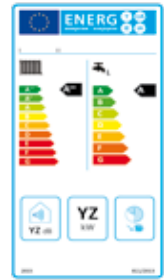

De Dietrich 

BDR THERMEA France
S.A.S. with corporate capital of 229 288 696 €
57, rue de la Gare - F - 67580 Mertzwiller
Tel. +33 3 88 80 27 00 - Fax +33 3 88 80 27 99
www.dedietrich-heating.com